

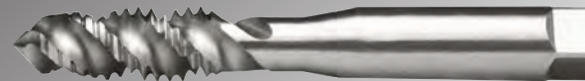

CLEVELAND

**Holemaking
Threading
Milling**

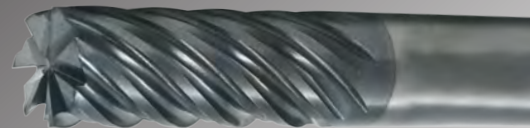
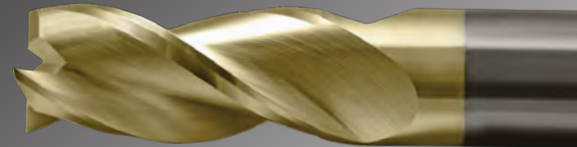
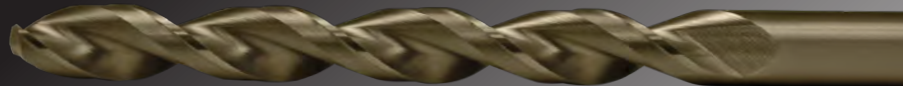

**MADE
IN THE
U.S.A.**

2021

Index by Style Number

0650	195,202	884	125	2002G-TC	37-41	6300	78	HG-2	241-243
0710	198	902	349	2006	55	6400	79	HG-2B	245
105	112	903	349	2011	66	10001	111	HG-2K	246
183	128-129	940E	103	2012	47-48	10003	111	HG-2KS	247
192	345	950E	98-99	2020	45-46	B-101	180	HG-2M	244
222	198	964B	187	2065	49-50	CEM-AM2	298	HG-3	252
223	200	965B	186	2065-TN	49-50	CEM-AM3	299-300	HG-4B	257
224	198	965TN	186	2075	51-54,84	CEM-CH2	322	HG-4C	253-255
225	200	966B	187	2075-TA	51-54	CEM-CH2D	322	HG-4MC	256
226	200	967B	188	2075-TC	51-54	CEM-CH4	323	HGA-2	250
240	201	975	186	2075-TN	51-54	CEM-CH4D	323	HGC-2	264-265
242	201	975TN	186	2120	22-23	CEM-DE2	303	HGC-2B	266
243	201	995	107	2133	30-33	CEM-DE2B	304	HGC-4B	269
244	201	996	105	2133-TC	30-33	CEM-DE4	305	HGC-4C	267-268
245	201	998	105	2175	24-26	CEM-DE4B	306	HGN-2	248
305	350	1001TN	162-164	2175-TA	24-26	CEM-EG2	321	HGN-2B	249
307	350	1001	162-165	2175-TC	24-26	CEM-EMS-3	296	HMD-2	230
318	351	1002	162-165,202	2175-TN	24-26	CEM-EMS-5	297	HMD-2B	231
321	350	1002L	166	2213	61-65,164	CEM-HPDE-5	295	HMD-4	232
326	351	1002SO	162-164	2222	58-60	CEM-RA	302	HMDC-2	260
327	352	1002TC	162-164	2228	56-57	CEM-RS	301	HMDC-4	261
413	352	1002TN	162-164	2330	27-29	CEM-SE2	309-310	HMG-2	233
415	352	1003	162-165	2410	100-101	CEM-SE2B	311-312	HMG-2B	234
421	352	1003TN	162-164	2411	100-101	CEM-SE3	313	HMG-4	235
426	352	1004	162-165	2412	100-101	CEM-SE4	316-317	HPDM-2	251
429	352	1011	168-170	2440	102	CEM-SE4B	320	PER-862P	177
460	352	1011E	172	2510	81-84	CEM-SEST2	321	PER-862SP	176
492	194	1011SO	168-169	2513	87	CEM-V2-5R	290-291	PER-893SF	183-184
550	199-200	1011TC	168-170	2540	88	CEM-V3-7R	292-293	PER-960SP	176-177
551	199-200	1011TN	168-170	2550	85-86	CEM-V3-7RCB	294	PER-980SF	183-184
552	199-200	1012	172	2565	89-90	CEM-V-4B	289,333	PM-2	275
553	199-200	1053	171	2565-TN	89-90	CEM-V-4R	286-288,333	PM-3	276
554	199	1091	185	2575	91-93	CI-1000	167	PM-4	277-278
610	112	1092	185	2575-TA	91-93	CI-1000-TC	167	PM-4B	279
610	196-197	1093	178	2575-TN	91-93	CMCE-2	307-308	PM-4DE	274
616	121	1093-TC	178	2635	109	CMCE-2AL	307-308	PM-538L	285
618	121	1093-TN	178	2636	108	CMCE-4	314-315	PM-538R	284
620	197	1094	178	2645	109	CMCE-4AL	314-315	PM-539L	281
642	122	1094-TC	178	2646	108	CMTM2	189	PM-539R	280
650	122	1094-TN	178	2727	70	CMTM3	190	PMRC-C	282
650	194-195	1095	179	2745	80	CMTMM2	189	PMRF-C	283
655	127	1096	179	3001	106	CMTMM3	190	PRO-861SP	174-175
657	123	110C1	110	3507	346	CRE	258-259	PRO-892SF	181-182
659	123	110C3	110	3517	347	CTM	191	PRO-961SP	174-175
660	195	110C6	110	3722-6	96-97	CTMBPP	193	PRO-981SF	181-182
710	196-197	1727	73-75	3722-12	96-97	CTMBPPC	193	RG6	270
850	346	1730	113	3780	67-69	CTMBPT	193	RG6-TA	270
851	347	1765	34	3780-TC	67-69	CTMBPTC	193	RG6-TC	270
852	348	1766	71-72	3957-6	94-95	CTMC	191	RG8	271-272
853	348	1767	35	3957-12	94-95	CTMNP	192	RG8-TA	271-272
855	346	1798	104	4001	114-117	CTMNPC	192	RG8-TC	271-272
856	347	1799	107	4005	119	HD-2	236-237	RG9	273
857	348	2001	43-44	4030	118	HD-2B	238	RG9-TC	273
860	346	2001G	37-41	4115	352	HD-3	239	T-101	173
861	347	2001M	352	4703	120	HD-4C	240		
879	124	2002	43-44	6100	76	HDC-2	262		
879P	126	2002G	37-42	6200	77	HDC-4C	263		



Brand of Greenfield Industries

*The name you've
trusted since 1874 for
quality cutting tools.*

Cleveland is a superior cutting tooling brand providing solutions to industry for over 140 years. During their long history, they've earned a reputation for the highest quality tools, outstanding customer service, and expert engineering technical advice.

Whatever your tooling need, whether you're drilling, threading, or milling, contact your Greenfield distributor for the ultimate in product and support solutions.



The  Cleveland tradition continues today at Greenfield Industries.

A History of Excellence



- ◆ **1874**
Cleveland Twist Drill established in Cleveland, Ohio.
- ◆ **1912**
Greenfield founded.
- ◆ **1995**
Greenfield Industries purchases Cleveland Twist Drill.
- ◆ **2009**
Greenfield Industries is acquired by TDC.
- ◆ **2010 - 2013**
Greenfield Industries moves all offices and operations to Seneca, SC.
- ◆ **2014**
TDC establishes Greenfield US and Canadian headquarters, as well as moving TDC overseas headquarters to Seneca, S.C., USA.

The Cleveland® brand is well-known throughout the world for its wide selection of premium cutting tools for drilling, countersinking, reaming, threading, and milling operations.



Its roots go back to the 1870's, when Cleveland Twist Drill was established as a premier cutting tool company in the United States. Cleveland has always been famous for the quality and reliability of its tools, and the company grew

to be one of the largest high-speed steel toolmakers in the US, expanding to overseas markets.

In 1995, Cleveland Twist Drill was acquired by Greenfield Industries Inc. (GFII), a U.S. based manufacturer of precision cutting tools.

Today, Greenfield Industries is part of TDC, the world's largest manufacturer of twist drills.



TDC

TDC Cutting Tools Company is one of the fastest growing cutting tool companies in the world and is the world market leader for high speed steel cutting tools.

Its vertical integration, covering the complete supply chain, from mining ore to smelting steel, to the blank shaft, and final product production, gives TDC a competitive advantage over its competitors in our increasingly volatile economy.



TDC employs around 3000 employees worldwide, produces over 300 million tools and 6000 miles of saw blades annually.

Operations including manufacturing, sales, and distribution have been established across the globe in China, Germany, France, Switzerland, Mexico, Canada, Brazil, Australia and the U.S.

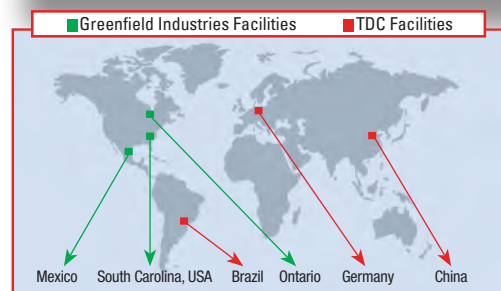

Environmentally-friendly recycling

TDC

World Market Leader for
High Speed Steel Cutting Tools



Integrated Global Manufacturer,
World Leader in Cutting Tools



Pioneer in Recycling Metal,
Making Life Easier and Cleaner

These tools are then used by the industries who build the products that move America.



GreenTech Global Recycling is a part of Top-Eastern Group and was founded in 2012. They supply large volume, special recycled metals that can be further processed by TDC global operations. GreenTech buys non-ferrous material that is industry specific to TDC from end-users, scrap and metal recyclers (including brokers), and local consumers.

telephone 800.348.2885

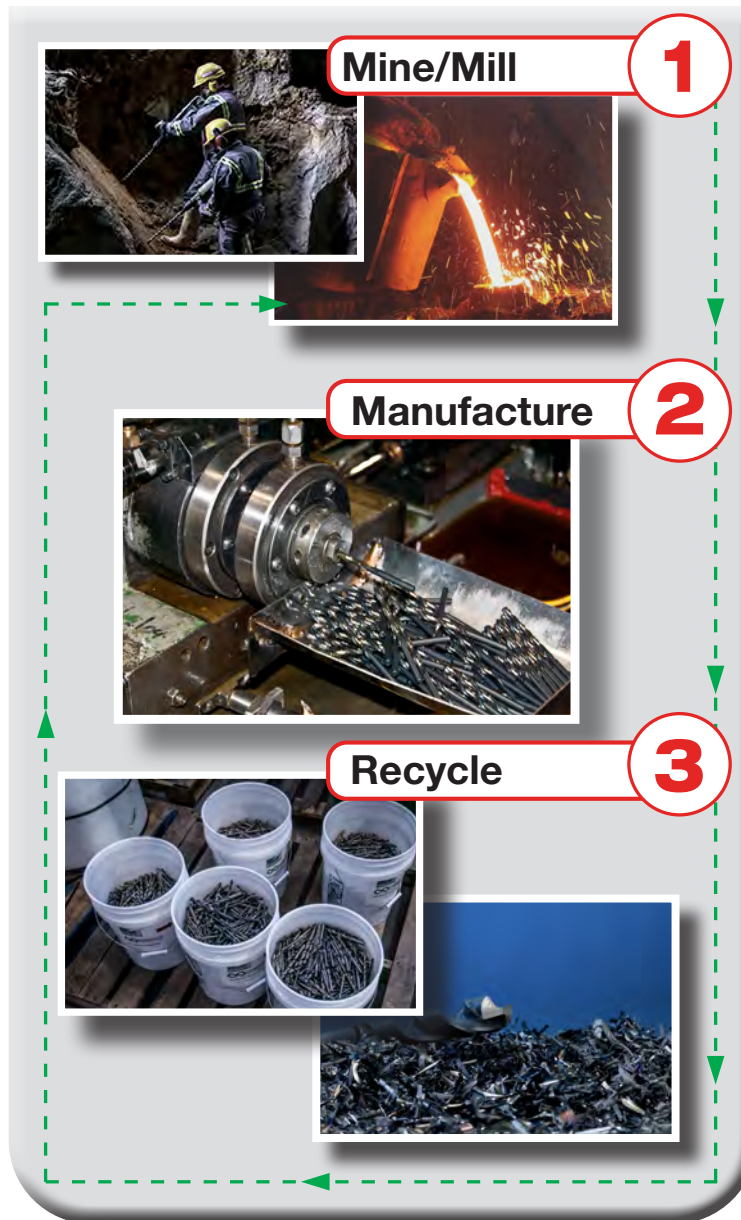

Mine/Mill

1

We are leading the industry.

360° Manufacturing

Mine/mill, manufacture, and recycle. Allowing us to control and provide a high quality, proprietary product material, while reducing waste and helping the environment.

As part of the TDC Group, we have direct access to the finest raw materials from our own mines.

These materials are then refined and made into the **exclusive raw material** used in manufacturing Greenfield's unparalleled drills, end mills, taps, dies; and other specially manufactured tools.

GreenTech supplies TDC with large volume, special recycled metals that can be further processed by TDC global operations.

Manufacture

2

Recycle

3



Through our recycling we are all able to make less impact on the environment and lower operating cost.

Up to 10% cash back or credit memo on market value.

Call: (864) 643-1030 greentechglobalrecycling.com

Whether an industrial facility, manufacturing plant or a local shop, your business will realize the following benefits; raw material/ore preservation, energy conservation and cost stabilization. Contact us for a quote on your material or for a free evaluation.

Welcome



Seneca, South Carolina manufacturing facility and U.S. headquarters.

Greenfield Industries' U.S. facility includes over 233,000 square feet for sales, engineering, manufacturing, and recycling. Our Cleveland brand is manufactured and shipped from Seneca, SC globally.



We have a unique ability to successfully custom-design products to meet our customers' needs. Our sales and engineering staff is always ready to assist with your tooling requirements.



The uncompromising commitment to quality, along with the hard work of our employees, Cleveland products continue to be a trusted name for over 140 years.



Quality product by quality people.

Knowledgeable and informed sales and engineering staff.

State-of-the-art machinery.

Manufactured in the U.S.A.



Our exclusive raw material developed for our manufacturing allows Greenfield to lead the industry in unparalleled drills, end mills, taps, dies, and other specialty manufactured tools.

Page 8

Holemaking

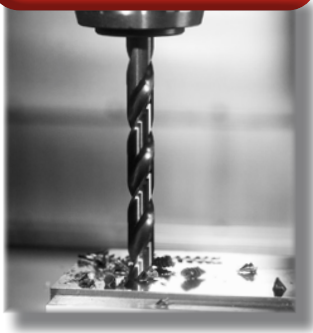

Drills, Reamers, Counterbores

Page 157

Threading



Thread Mills, Taps

Page 224

Milling



End Mills

Page 344

Other Tools



Screw Extractors, Saws, etc.

Our Cleveland brand is manufactured in high speed steel, cobalt, and carbide, as well as other materials, allowing us to provide quality products for a wide range of industries with our variety of tools.



Medical



Aerospace



Energy



Automotive

Metal Cutting Safety

(read this before using Cleveland® products)

Modern metal cutting operations involve high energy, high spindle or cutter speeds, and high temperatures and cutting forces. Hot, flying chips may be projected from the workpiece during metal-cutting. Although advanced cutting tool materials are designed and manufactured to withstand the high cutting forces and temperatures that normally occur in these operations, they are susceptible to fragmenting in service, particularly if they are subjected to over-stress, severe impact or otherwise abused. Therefore, precautions should be taken to adequately protect workers, observers and equipment against hot, flying chips, fragmented cutting tools, broken work pieces or other similar projectiles. Machines should be fully guarded and personal protective equipment should be used at all times.

When grinding advanced cutting tool materials, a suitable means for collection and disposal of dust, mist or sludge should be provided. Overexposure to dust or mist containing metallic particles can be hazardous to health particularly if exposure continues over an extended period of time and may cause eye, skin and mucous membrane irritation and temporary or permanent respiratory disease. Certain existing pulmonary and skin conditions may be aggravated by exposure to dust or mist. Adequate ventilation, respiratory protection and eye protection should be provided when grinding and workers should avoid breathing of and prolonged skin contact with dust or mist.

General Industry Safety and Health Regulations, Part 1910, U.S. Department of Labor, published in Title 29 of the Code of Federal Regulations should be consulted. Obtain from Cleveland® and read the applicable Material Safety Data Sheet before grinding.

Cutting tools are only one part of the worker-machine-tool system. Many variables exist in machining operations, including the metal removal rate; the workpiece size, shape, strength and rigidity; the chucking and fixturing; the load carrying capability of centers; the cutter and spindle speed and torque limitations; the holder and boring bar overhang; the available power; and the condition of the tooling and the machine. A safe metal cutting operation must take all of these variables, and others, into consideration.





Cleveland® has no control over the end use of its products or the environment into which those products are placed. Cleveland® urges that its customers adhere to the recommended standards of use of their metal cutting operations. The information included throughout this catalog under the heading "Technical Data" and other recommendations on machining practices referred to herein are only advisory in nature and do not constitute representations or warranties and are not necessarily appropriate for any particular work environment or application.







WARNING: This product contains Cobalt and/or Nickel and/or Lead a chemical known to the state of California to cause cancer or birth defects or other reproductive harm. For more information: www.P65Warnings.ca.gov



Screw Machine / Stub Length Drills					Tool Material			Application					Point				Surface Treatment								
	Type	Style	Page	Set	HSS	Cobalt	Carbide	TCT	Steel	Stainless	Cast Iron	Non-Ferrous	High-Temp Alloy	Hardened Steel	118°	118° Split	118° 4-facet	118° K-Notch	135° Split	Bright	Black Oxide	Straw	TIN	TICN	TIAIN
	General Purpose	2120	22	yes	•				•						•					•					
	Wide Land Parabolic	2175	24			•			•										•			•	•	•	•
	NAS907-C Heavy Duty	2330	27	yes	•				•										•	•					
	NAS907-K Heavy Duty	2133	30			•			•										•			•	•	•	•
	Spade Drill	1765	34				•		•					•	•					•					
	Stub Length	1767	35				•		•					•		•				•					

Jobber Drills					Tool Material			Application					Point				Surface Treatment								
	Type	Style	Page	Set	HSS	Cobalt	Carbide	TCT	Steel	Stainless	Cast Iron	Non-Ferrous	High-Temp Alloy	Hardened Steel	118°	118° Split	118° 4-facet	118° K-Notch	135° Split	Bright	Black Oxide	Straw	TIN	TICN	TIAIN
	General Purpose	*2001G, 2002G	37	yes	•				•						•					•				•	
	General Purpose	2001, 2002	43	yes	•				•						•					•					
	Low Helix	2020	45		•				•						•					•					
	High Helix	2012	47		•				•						•					•					
	Parabolic	2065	49		•				•								•			•			•		
	Wide Land Parabolic	2075	51	yes	•				•										•			•	•	•	•
	Left Hand	2006	55		•				•						•					•					
	NAS907-A General Purpose	2228	56		•				•						•					•					
	NAS907-B Heavy Duty	2222	58	yes	•				•										•	•					
	NAS907-J Heavy Duty	2213	61	yes	•				•										•			•	•	•	•
	Cotter Pin Heavy Duty	2011	66		•				•										•		•				
	Q-AMD Short Flute	3780	67	yes	•				•										•					•	
	Carbide Tipped	2727	70				•		•						•					•					
	Straight Flute	1766	71				•		•								140° 4-facet			•					
	Heavy Duty	1727	73				•		•								•			•					

*Tool Material is Premium HSS

Common Shank Drills					Tool Material				Application				Point				Surface Treatment								
					HSS	Cobalt	Carbide	TCT	Steel	Stainless	Cast Iron	Non-Ferrous	High-Temp Alloy	Hardened Steel	118°	118° Split	118° 4-facet	118° K-Notch	135° Split	Bright	Black Oxide	Straw	TiN	TiCN	TiAlN
					Type	Style	Page	Set																	
	External Coolant Single Margin	6100	76																						
	Internal Coolant Single Margin	6200	77																						
	Internal Coolant Double Margin	6300	78																						
	Internal Coolant Double Margin	6400	79																						

Taper Length Drills					Tool Material				Application				Point				Surface Treatment								
					HSS	Cobalt	Carbide	TCT	Steel	Stainless	Cast Iron	Non-Ferrous	High-Temp Alloy	Hardened Steel	118°	118° Split	118° 4-facet	118° K-Notch	135° Split	Bright	Black Oxide	Straw	TiN	TiCN	TiAlN
					Type	Style	Page	Set																	
	Carbide Tipped Heavy Duty, Tanged	2745	80																						
	General Purpose	2510	81	yes																					
	High Helix	2550	85																						
	Heavy Duty, Tanged	2513	87																						
	Auto. Tanged Shank Heavy Duty	2540	88																						
	Parabolic, Tanged	2565	89																						
	Wide Land Parabolic	2575	91																						





Aircraft Extension Drills					Tool Material				Application				Point				Surface Treatment								
					HSS	Cobalt	Carbide	TCT	Steel	Stainless	Cast Iron	Non-Ferrous	High-Temp Alloy	Hardened Steel	118°	118° Split	118° 4-facet	118° K-Notch	135° Split	Bright	Black Oxide	Straw	TiN	TiCN	TiAlN
					Type	Style	Page	Set																	
	NAS907-B 6" and 12"	3957	94																						
	NAS907-J 6" and 12"	3722	96																						







Extra Length Drills					Tool Material				Application				Point				Surface Treatment								
					HSS	Cobalt	Carbide	TCT	Steel	Stainless	Cast Iron	Non-Ferrous	High-Temp Alloy	Hardened Steel	118°	118° Split	118° 4-facet	118° K-Notch	135° Split	Bright	Black Oxide	Straw	TiN	TiCN	TiAlN
					Type	Style	Page	Set																	
	Extra Length	950E	98																						

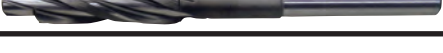







Taper Shank Drills					Tool Material			Application					Point				Surface Treatment								
	Type	Style	Page	Set	HSS	Cobalt	Carbide	TCT	Steel	Stainless	Cast Iron	Non-Ferrous	High-Temp Alloy	Hardened Steel	118°	118° Split	118° 4-facet	118° K-Notch	135° Split	Bright	Black Oxide	Straw	TiN	TiCN	TiAlN
	Standard	2410	100		•				•		•				•						•				
	Undersized	2411	100		•				•		•				•						•				
	Oversized	2412	100		•				•		•				•						•				
	Cobalt Heavy Duty	2440	102			•			•	•	•				135° Mod. Point						•				
	Extra Length	940E	103		•				•		•							•			•				







Misc. Drills					Tool Material			Application					Point		Surface Treatment									
	Type	Style	Page	Set	HSS	Cobalt	Carbide	Steel	Stainless	Cast Iron	Non-Ferrous	High-Temp Alloy	Hardened Steel	118°	Various degrees - see product page	Bright	Black Oxide	Straw	TiN	TiCN	TiAlN			
	Combined Drill Countersink	1798	104				•	•	•	•	•				60°	•								
	Bell Type Drill & Countersink	996	105		•			•	•	•	•			•	60°, 120°	•								
	Plain Drill & Countersink	998	105	yes	•			•	•	•	•			•	60°	•								
	Countersink & Deburring	3001	106	yes		•		•	•	•	•				60°, 82°, 90°, 100°	•								
	Spotting & Centering - Short	995	107		•			•	•	•	•			•		•								
	Spotting & Centering - Long	1799	107			•		•	•	•	•				90°, 120°, 142°									•
	NC Spotting & Centering - Short	2636	108	yes		•		•	•	•	•				90°, 120°			•						
	Spotting & Centering - Long	2646	108	yes		•		•	•	•	•				90°, 120°			•						
	NC Spotting Drill - Short	2635	109	yes	•			•	•	•	•				90°, 120°	•								
	NC Spotting Drill - Long	2645	109	yes	•			•	•	•	•				90°, 120°	•								
	Single Flute Countersink	110C1	110				•	•	•	•	•				60°, 82°, 90°, 100°, 120°			•						
	3 Flute Countersink	110C3	110				•	•	•	•	•				60°, 82°, 90°, 100°, 120°			•						
	6 Flute Countersink	110C6	110				•	•	•	•	•				60°, 82°, 90°, 100°, 120°			•						
	Single Flute Countersink	10001	111	yes	•			•	•	•	•				60°, 82°, 90°, 100°, 120°			•						
	3 Flute Countersink	10003	111	yes	•			•	•	•	•				60°, 82°, 90°, 100°, 120°			•						
	4 Flute Countersink	610	112	yes	•			•	•	•	•				60°, 82°, 90°, 100°			•						
	Drift Drill	105	112		•			•								•								



					Tool Material		Application					Hole		Surface Treatment			
					HSS	Cobalt	Carbide	Steel	Stainless	Cast Iron	Non-Ferrous	High-Temp Alloy	Hardened Steel	Blind Hole	Thru Hole	Bright	Black Oxide
Type	Style	Page	Set														
	Straight Shank, Straight Flute	1730	113		•		•	•	•			•	•				
	Straight Shank, Straight Flute	4001	114	yes	•		•	•	•			•	•				
	Straight Shank, Spiral Flute	4030	118		•		•	•	•			•	•				
	Taper Shank, Straight Flute	4005	111		•		•	•	•			•	•				
	Straight Shank, Straight Flute	4703	120		•		•	•	•			•	•				
	Taper Shank, Bridge Reamer	616	121		•		•	•	•				•				
	Taper Shank, Car Reamer	618	121		•		•	•	•				•				
	Taper Pipe Reamer	642	122		•		•	•	•				•				
	High Spiral Spirex Taper Pin	650	122		•		•	•	•				•				
	Taper Pin Straight Shank, Straight Flute	657	123		•		•	•	•				•				
	Taper Pin Straight Shank, Helical Flute	659	123		•		•	•	•				•				



					Tool Material		Application					Helix		Surface Treatment			
					HSS	Cobalt	Carbide	Steel	Stainless	Cast Iron	Non-Ferrous	High-Temp Alloy	Hardened Steel	Blind Hole	Thru Hole	Bright	Black Oxide
Type	Style	Page	Set														
	Straight Shank C'bore & Spot Facer	879	124		•		•	•	•				•				
	Short Aircraft Type	884	125		•		•	•	•				•				
	Interchangeable Pilot for Style 879 & 884	879P	126		•		•	•	•				•				
	Clearance or Taper Router	655	127		•		•	•	•				•				
	3 Flute Continuous Pilot	183	183	yes	•		•	•	•				•				

Straight Flute					Tool Material	Blank		Chamfer			Application				Hole		Surface Treatment												
Type	Style	Page	Set		HSS	HSS-E	302A	311	DIN / ANSI	Taper	Plug	Bottoming	Mod Bottoming	Steel	Stainless	Cast Iron	Non-Ferrous	High-Temp Alloy	Hardened Steel	Blind	Thru	Bright	Black Oxide	TiN	TiCN	TiAlN	AlCrN	Oxide over Nitride	Hardlube
	General Purpose	1001	162	yes	•	•				•				•	•	•	•				•	•	•						
	General Purpose	1002	165	yes	•	•					•			•	•	•	•				•	•	•						
	General Purpose	1003	165	yes	•	•						•		•	•	•	•			•	•	•							
	Set (Styles: 1001, 1002, 1003)	1004	165	yes	•	•				•	•	•		•	•	•	•				•	•							
	General Purpose - Left Hand	1002L	166		•	•					•			•	•	•	•				•	•							
	Cast Iron	CI-1000	167		•	•							•	•	•	•	•										•		







Spiral Point					Tool Material	Blank		Chamfer			Application				Hole		Surface Treatment												
Type	Style	Page	Set		HSS	HSS-E	302A	311	DIN / ANSI	Taper	Plug	Bottoming	Mod Bottoming	Steel	Stainless	Cast Iron	Non-Ferrous	High-Temp Alloy	Hardened Steel	Blind	Thru	Bright	Black Oxide	TiN	TiCN	TiAlN	AlCrN	Oxide over Nitride	Hardlube
	General Purpose	1011	168		•	•					•			•	•	•	•				•	•	•						
	Low Shear	1053	171		•	•					•			•	•	•	•				•	•	•						
	Bottoming	1012	172		•	•						•		•	•	•	•			•	•	•							
	6" Extended Length	1011E	172		•	•	303-A				•			•	•	•	•				•	•							
	Stainless Steel & Steel	T-101	173		•	•					•			•	•	•	•				•	•	•						
	Universal	PRO-961SP	174		•	•					•			•	•	•	•				•	•	•						
	Universal	PRO-861SP		•	•	•						•			•	•	•	•				•	•	•					
	Stainless Steel	PER-862SP	176		•	•					•			•	•	•	•				•	•	•						
	Stainless Steel	PER-960SP		•	•	•						•			•	•	•	•				•	•	•					•











Spiral Flute					Tool Material	Blank	Chamfer	Application	Hole	Surface Treatment																			
					HSS	HSS-E	302A	311	DIN / ANSI	Taper	Plug	Bottoming	Mod Bottoming	Steel	Stainless	Cast Iron	Non-Ferrous	High-Temp Alloy	Hardened Steel	Blind	Thru	Bright	Black Oxide	TiN	TiCN	TiAlN	AlCrN	Oxide over Nitride	Hardlube
	Type	Style	Page	Set																									
	General Purpose	1093	178		•	•					•			•	•	•				•		•	•						
	General Purpose	1094	178		•	•						•		•	•	•				•		•	•						
	Heavy Duty	1095	179		•	•					•			•	•	•				•		•	•						
	Heavy Duty	1096	179		•	•					•			•	•	•				•		•	•						
	Stainless Steel & Steel	B-101	180		•	•						•		•	•	•				•		•	•						
	Universal	PRO-981SF	181		•	•						•		•	•	•				•		•	•						
	Universal	PRO-892SF			•	•							•		•	•	•				•		•	•					
	Stainless Steel	PER-893SF	183		•	•						•		•	•	•				•		•	•						
	Stainless Steel	PER-980SF			•	•							•		•	•	•				•		•	•					•

Form					Tool Material	Blank	Chamfer	Application	Hole	Surface Treatment																			
					HSS	HSS-E	302A	311	DIN / ANSI	Taper	Plug	Bottoming	Mod Bottoming	Steel	Stainless	Cast Iron	Non-Ferrous	High-Temp Alloy	Hardened Steel	Blind	Thru	Bright	Black Oxide	TiN	TiCN	TiAlN	AlCrN	Oxide over Nitride	Hardlube
	Type	Style	Page	Set																									
	General Purpose	1091	185		•	•					•			•	•	•				•		•	•						
	General Purpose	1092	185		•	•						•		•	•	•				•		•	•						

Pipe					Tool Material	Blank	Chamfer	Application	Hole	Surface Treatment																			
					HSS	HSS-E	302A	311	DIN / ANSI	Taper	Plug	Bottoming	Mod Bottoming	Steel	Stainless	Cast Iron	Non-Ferrous	High-Temp Alloy	Hardened Steel	Blind	Thru	Bright	Black Oxide	TiN	TiCN	TiAlN	AlCrN	Oxide over Nitride	Hardlube
	Type	Style	Page	Set																									
	NPT Medium Hook	965	186		•	•								•	•	•				•		•	•						
	NPTF Medium Hook	975	186		•	•									•	•	•				•		•	•					
	NPT Interrupted Thread	964B	187		•	•								•	•	•				•		•	•						
	NPTF Interrupted Thread	966B	187		•	•									•	•	•				•		•	•					
	NPS	963B	188		•	•								•	•	•				•		•	•						
	NPSF	967B	188		•	•									•	•	•				•		•	•					





Index

Thread Mills					Tool Material		Thread								Application					Coolant		Surface Treatment						
	Type	Style	Page	Set	HSS	Cobalt	Carbide	UNC	UNF	NPT	NPTF	Metric Coarse	Metric Fine	BSPP	BSPT	DIN	Steel	Stainless	Cast Iron	Non-Ferrous	Special Alloy	Hardened Steel	Non	Thru	TAIN	AlCrN	Hardlube	
	Mini	CMTM2, CMTMM2	189			•	•	•				•	•				•	•	•	•	•	•	•			•		
	Mini	CMTM3, CMTMM3	190			•	•	•				•	•				•	•	•	•	•	•	•			•		
	General Purpose - Inch	CTM, CTMC	191			•	•	•									•	•	•	•	•	•	•	•	•			
	General Purpose - Metric	CTMM, CTMMC	192			•									•		•	•	•	•	•	•	•	•	•			
	National Pipe Tapered	CTMNP, CTMNPC	192			•			•	•							•	•	•	•	•	•	•	•	•			
	British Pipe Tapered	CTMBPP, CTMBPPC	193			•								•			•	•	•	•	•	•	•	•	•			
	British Pipe Parallel	CTMBPT, CTMBPTC	193			•								•			•	•	•	•	•	•	•	•	•			

Dies					Tool Material			Surface Treatment						
					HSS	Carbon Steel	Steel	Bright	Black Oxide	TiN	TiCN	TiAlN	AlCrN	Oxide over Nitride
	Type	Style	Page	Set										
	Hexagon Rethreading	0650, 0650M, 492	194-195	yes	•	•		•						
	Taper Pipe	0660			•	•		•						
	Round Adjustable	0610, 0710	196-198		•	•		•						
	Round Adjustable	0710M			•			•						
	Round Adjustable - Pipe	0620				•		•						
	Die Stock, Adjustable	222	198											
	Die Stock, Built-in Workpiece Guide	224	198											
	Die Set: Die Halves	0550	199-200				•	•						
	Die Set: Cap	0551			•	•								
	Die Set: Guide	0552			•	•								
	Die Set: Collet (cap and guide)	0553			•	•								
	Die Set Assembly (0550,0553,0551,0552)	0554			•	•								
	Quick Set Die Stock	223	200		•			•						
	Quick Set Jr. Die Stock	225	200		•			•						
	Quick Set Spanner Wrench	226	200											





Index

Wrenches











	Type	Style	Page		Type	Style	Page
	Straight Wrench	240	201		Combo Ratchet & Slip Handle Wrench	244	201
	Plain T-Handle Wrench	242	201		Long Shank T-Handle Wrench	245	201
	Slip T-Handle Wrench	243	201				

High Speed Steel

				End Work			Application					Machining					Surface Treatment					
				Square	Ball	Chamfer	Radius/Rounding	Steel	Stainless	Cast Iron	Non-Ferrous	High-Temp Alloy	Hardened Steel	Slot	Profile	Plunging	Ramping	Drilling	Chamfer	Slot w/ Radius	Bright	TiN
Type	Style	Page	No. of Flutes																			
	Miniature	HMD-2	230	2	•					•	•	•	•					•			•	
	Miniature	HMD-2B	231	2		•				•	•	•	•				•	•				
	Miniature	HMD-4	232	4	•					•	•	•	•					•				
	Miniature	HMG-2	233	2	•					•	•	•	•					•				
	Miniature	HMG-2B	234	2		•				•	•	•	•				•	•				
	Miniature	HMG-4	235	4	•					•	•	•	•					•				
	Finisher	HD-2	236	2	•					•	•	•	•					•	•	•		
	Finisher	HD-2B	238	2		•				•	•	•	•				•	•	•			
	Finisher	HD-3	239	3	•					•	•	•	•					•	•	•		
	Finisher	HD-4C	240	4	•					•	•	•	•					•	•	•		
	Finisher	HG-2	241	2	•					•	•	•	•					•	•	•		
	Finisher	HG-2M	244	2	•					•	•	•	•					•				
	Finisher	HG-2B	245	2		•				•	•	•	•					•	•	•		
	Keyway	HG-2K	246	2	•					•	•	•	•					•	•	•		
	Keyway Cutter	HG-2KS	247	2	•					•	•	•	•					•				
	Finisher - Extended Neck	HGN-2	248	2	•					•	•	•	•					•				
	Finisher - Extended Neck	HGN-2B	249	2		•				•	•	•	•					•				
	Finisher - High Helix	HGA-2	250	2	•					•	•	•	•					•	•	•		
	Finisher - Drill Mill	HPDM-2	251	2				<i>Pointed end</i>		•	•	•	•					•	•	•		
	General Purpose	HG-3	252	3	•					•	•	•	•					•	•	•		

High Speed Steel (continued)				No. of Flutes	End Work			Application					Machining					Surface Treatment						
Type	Style	Page			Square	Ball	Chamfer	Radius/Rounding	Steel	Stainless	Cast Iron	Non-Ferrous	High-Temp Alloy	Hardened Steel	Slot	Profile	Plunging	Ramping	Drilling	Chamfer	Slot w/ Radius	Bright	TiN	TiCN
	General Purpose	HG-4C	252	M	•			•	•	•					•		•				•	•	•	
	General Purpose	HG-4MC	256	4	•			•	•	•					•		•				•	•	•	
	General Purpose	HG-4B	257	4		•		•	•	•					•		•				•	•	•	
	Left Hand Helix / Cut	HG-4LL	258	4	•			•	•	•					•		•				•	•	•	
	Corner Radius	CRE	259	4			•	•	•	•					•						•	•	•	

M = Multi Flute

Cobalt				No. of Flutes	End Work			Application					Machining					Surface Treatment						
Type	Style	Page			Square	Ball	Chamfer	Radius	Steel	Stainless	Cast Iron	Non-Ferrous	High-Temp Alloy	Hardened Steel	Slot	Profile	Plunging	Ramping	Drilling	Chamfer	Slot w/ Radius	Bright	TiN	TiCN
	Miniature End Mill	HMDC-2	260	2	•			•	•	•				•	•	•	•				•	•	•	
	Miniature End Mill	HMDC-4	261	4	•			•	•	•					•		•				•	•	•	
	Finisher	HDC-2	262	2	•			•	•	•				•	•	•	•				•	•	•	
	Finisher	HDC-4C	263	4	•			•	•	•					•		•				•	•	•	
	Finisher	HGC-2	264	2	•			•	•	•				•	•	•	•				•	•	•	
	Finisher	HGC-2B	266	2		•		•	•	•				•	•	•	•				•	•	•	
	Finisher	HGC-4C	267	M	•			•	•	•					•		•				•	•	•	
	Finisher	HGC-4B	269	M		•		•	•	•					•		•				•	•	•	
	Rougher Fine Pitch	RG6	270	M	•			•	•	•					•		•				•	•	•	
	Rougher Coarse Pitch	RG8	271	M		•		•	•	•					•		•	•			•	•	•	
	Rougher - Extra Coarse Pitch	RG9	273	3		•		•	•	•					•		•	•			•	•	•	

M = Multi Flute

Powdered Metal

				End Work				Application					Machining					Surface Treatment							
Image	Type	Style	Page	No. of Flutes	Square	Ball	Chamfer	Radius	Steel	Stainless	Cast Iron	Non-Ferrous	High-Temp Alloy	Hardened Steel	Slot	Profile	Plunging	Ramping	Drilling	Chamfer	Slot w/ Radius	Bright	TiN	TiCN	TiAlN
	Finisher	PM-4DE	274	4	•				•	•	•	•	•	•	•							•	•	•	•
	Finisher	PM-2	275	2	•				•	•	•	•	•	•	•	•	•	•				•	•	•	•
	Finisher	PM-3	276	3	•				•	•	•	•	•	•	•	•	•	•				•	•	•	•
	Finisher	PM-4	277	M	•				•	•	•	•	•	•	•	•	•	•				•	•	•	•
	Finisher	PM-4B	279	4		•			•	•	•	•	•	•	•	•	•	•				•	•	•	•
	Finisher High Helix	PM-539R	280	3	•		•		•	•	•	•	•	•	•	•	•	•			•	•	•	•	•
	Finisher - Left - High Helix/Cut	PM-539L	281	3	•				•	•	•	•	•	•	•	•	•	•			•	•	•	•	•
	Rougher Coarse Profile	PMRC-C	282	M	•				•	•	•	•	•	•	•	•	•	•				•	•	•	•
	Rougher Fine Profile	PMRF-C	283	M	•				•	•	•	•	•	•	•	•	•	•				•	•	•	•
	Rougher Coarse Profile	PM-538R	284	3	•				•	•	•	•	•	•	•	•	•	•				•	•	•	•
	Rougher - Left Low Helix/Cut	PM-538L	285	3	•				•	•	•	•	•	•	•	•	•	•				•	•	•	•













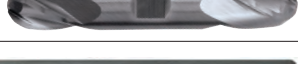
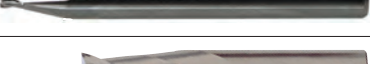
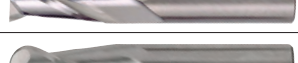
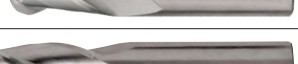
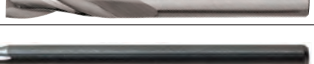
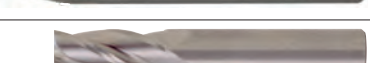

M = Multi Flute

Carbide

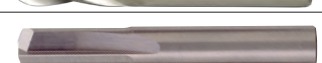
Tolerances for Solid Carbide End Mills
Cutting Diameter: 1/32" through 1": +0.000 - 0.002
Shank Diameter: h6

				End Work				Application					Machining					Surface Treatment								
Image	Type	Style	Page	No. of Flutes	Square	Ball	Chamfer	Radius	Steel	Stainless	Cast Iron	Non-Ferrous	High-Temp Alloy	Hardened Steel	Slot	Profile	Plunging	Ramping	Drilling	Chamfer	Slot w/ Radius	Bright	TiCN	TiAlN	AlCrN	ZrN
						Variable Index Ferrous Material	CEM-V-4R	286	4	•				•	•	•	•	•	•	•	•	•	•			
	Variable Index Ferrous Material	CEM-V-4B	289	4		•			•	•	•	•	•	•	•	•	•	•				•	•	•	•	•
	Variable Index Ferrous Material	CEM-V2-5R	290	5	•				•	•	•	•	•	•	•	•	•	•				•	•	•	•	•
	Steel Material	CEM-V3-7R CEM-V3-7RCB	292	7	•				•	•	•	•	•	•	•	•	•	•				•	•	•	•	•
	Steel Material	CEM-HPDE-5	295	5	•				•	•	•	•	•	•	•	•	•	•				•	•	•	•	•
	Steel Material	CEM-EMS-3	296	3	•				•	•	•	•	•	•	•	•	•	•				•	•	•	•	•
	Steel Material	CEM-EMS-5	297	5	•				•	•	•	•	•	•	•	•	•	•				•	•	•	•	•

Carbide (continued)

	Type	Style	Page	No. of Flutes	End Work				Application					Machining					Surface Treatment				
					Square	Ball	Chamfer	Radius	Steel	Stainless	Cast Iron	Non-Ferrous	High-Temp Alloy	Hardened Steel	Slot	Profile	Plunging	Ramping	Drilling	Chamfer	Slot w/ Radius	Bright	TiCN
	Aluminum Material	CEM-AM2	298	2	•				•	•	•	•							•				•
	Aluminum Material	CEM-AM3	299	3	•				•	•	•	•							•				•
	Rougher	CEM-RS	301	4	•				•	•	•	•		•					•				•
	Rougher	CEM-RA	302	3	•				•	•	•	•		•					•	•			•
	General Purpose	CEM-DE2	303	2	•				•	•	•	•		•					•				•
	General Purpose	CEM-DE2B	304	2		•			•	•	•	•		•					•				•
	General Purpose	CEM-DE4	305	4	•				•	•	•	•		•					•				•
	General Purpose	CEM-DE4B	306	4		•			•	•	•	•		•					•				•
	Miniature	CMCE-2 CMCE-2AL	307	2	•				•	•	•	•	•	•					•				•
	General Purpose	CEM-SE2	309	2	•		•		•	•	•	•		•					•				•
	General Purpose	CEM-SE2B	311	2		•			•	•	•	•		•					•				•
	General Purpose	CEM-SE3	313	3	•		•		•	•	•	•		•					•				•
	Miniature	CMCE-4 CMCE-4AL	314	4	•				•	•	•	•	•	•					•				•
	General Purpose	CEM-SE4	316	4	•		•		•	•	•	•		•					•				•
	General Purpose	CEM-SE4B	319	4		•			•	•	•	•		•					•				•
	Straight Flute	CEM-SEST2	321	2					•	•	•	•		•					•				•
	Engraving Tool	CEM-EG2	321	2		•			•	•	•	•		•					•				•
	Chamfer Tool	CEM-CH2	322	2			•		•	•	•	•		•					•				•
	Chamfer Tool	CEM-CH2D	322	2			•		•	•	•	•		•					•				•
	Chamfer Tool	CEM-CH4	323	4			•		•	•	•	•		•					•				•
	Chamfer Tool	CEM-CH4D	323	4			•		•	•	•	•		•					•				•

M = Multi Flute

Cleveland offers an extensive array of holemaking tools. The Cleveland brand is known for performance tools that run faster, longer, and with more precision than competitive tools. This Holemaking section includes: screw machine length, stub length, jobber length, taper length, AC extension, extra length, taper shank, as well as miscellaneous drills, reamers, and counterbores. We have a large selection of surface treatments, and industry specific application products.

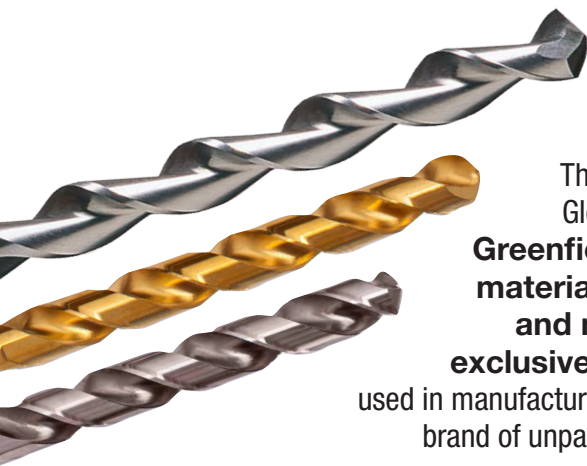

Through GreenTech Global Recycling all **Greenfield Industries materials are refined and made into the exclusive raw material** used in manufacturing the Cleveland brand of unparalleled products.

TECH TIP

Split Point versus Traditional Point

The right drill bit can help you work smarter & faster, and even save you money — if you know which features to look for.

If you're drilling by hand, choose a drill with a split point: it drills on contact.

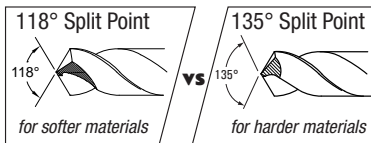

You'll get a faster start and there's no walking. And you're less likely to need a center punch to get started, thanks to the split point's four cutting edges. Those extra edges cause the split point to drill rounder holes faster,

while generating less heat with less force. That means you're working faster and getting more holes per charge with your cordless drill. The split point tool is versatile: it also performs well in presses, CNC machines, and more.

The heavy duty construction of split point drill bits make them a great choice when you work with hard materials like cast iron, stainless steel and alloy steels. Split point bits are available from Greenfield Industries in cobalt and High Speed steel.

You can expect a longer life from Greenfield Industries' heavy duty split point drill, with fewer broken bits.

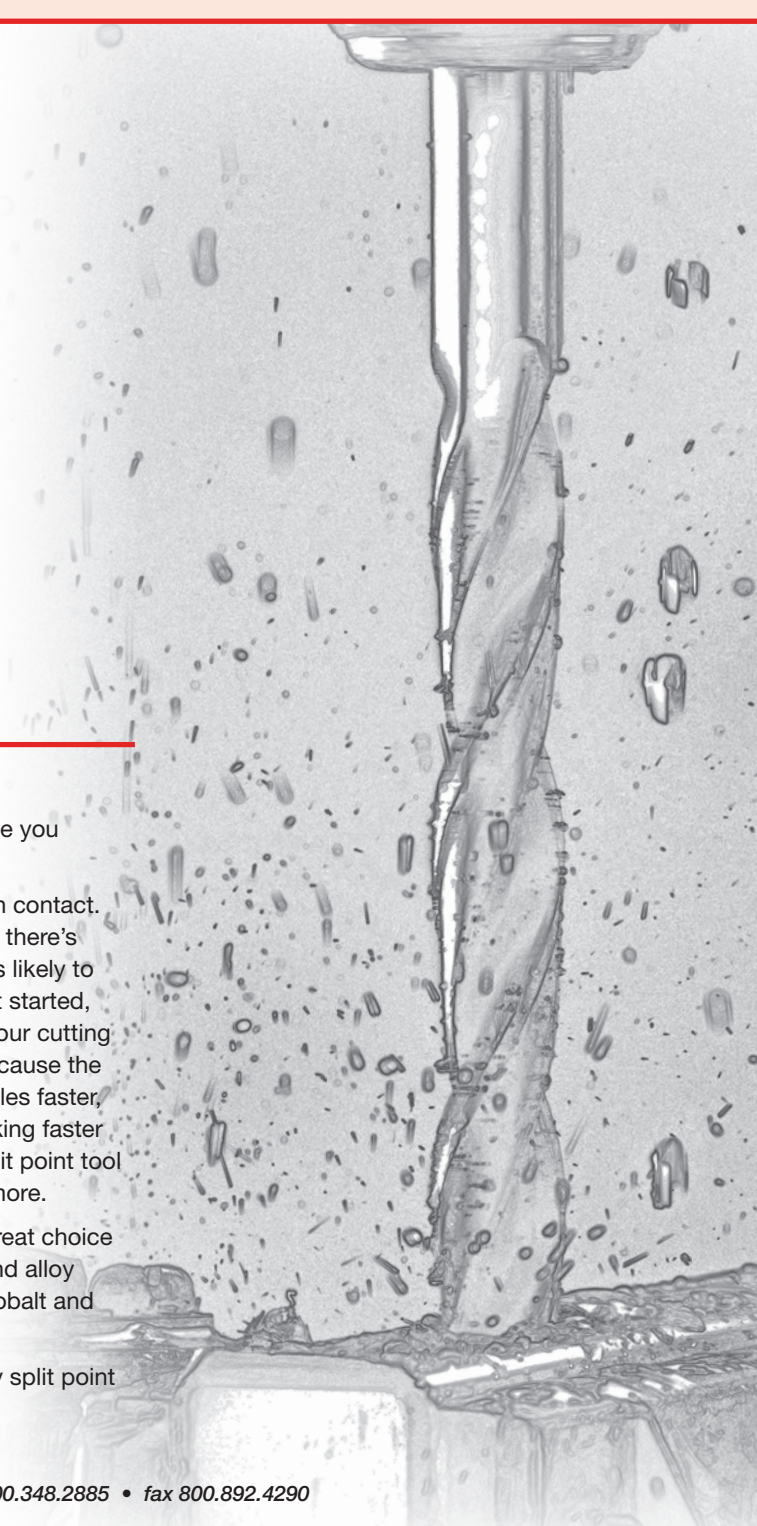

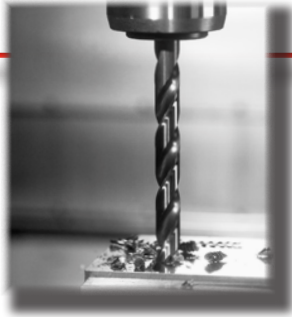

Holemaking Product Index 8-11

- | | |
|-----------------------------|----------------------|
| Screw Machine Length Drills | Extra Length Drills |
| Stub Length Drills | Taper Shank Drills |
| Jobber Length Drills | Miscellaneous Drills |
| Taper Length Drills | Reamers |
| AC Extension Drills | Counterbores |

Cost Saving Sets

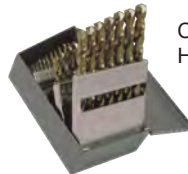

Complete list of Holemaking Sets **130-131**



Technical Information

Nomenclature	124
High Speed Steel Drills	
Material Class	125
Operating Parameters	126
Surface Treatments	127
Special Drills	127
Common Shank Drills	
Speeds & Feeds	128
Drilling Method	129
Cobalt Drills	
Material Class	130
Operating Parameters	131
Drill Cutting Speeds	132
Dimensional Specifications	135
Shank / Tang	141
Morse Taper Shank	141
Reamers	
Custom Reamers	142
Reamer Speeds and Feeds	144
Tolerances / Regrinding	145
Reamer Cutting Speeds	146

TECH TIPS

Split Point versus Traditional Point	20
Benefits of 2133 Cobalt Screw Machine Drill	30
Bright vs. Surface Treated Tools	44
Heavy Duty Automotive Tang Taper Length Drills	88
Morse Taper Shank Specifications	102
Using Spotting and Centering Drills	107
Point Angle: 90° vs 120°	107
Using Drill Drifts	112
How to Select Correct Reamer Style	113
Aircraft Type Counterbores	125
Clearance or Taper Router	127

Surface Treatment

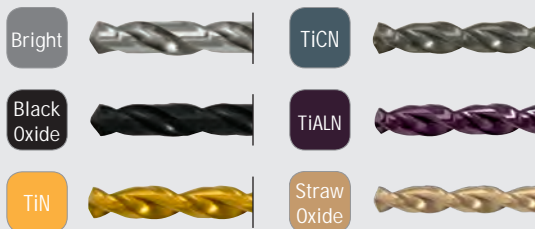

Additional treatments available upon request.



General Purpose

Style: **2120**

Screw Machine Length

High Speed Steel

Note

* 1-1/16" through 1-1/4" drills have 1" diameter reduced shank.

Operating parameters: See Technical section

ASME
B94.11M

HSS

118°

Helix
Regular
21° to 34°

Straight
Shank

*
Reduced
Shank

Surface
Treatment

Bright

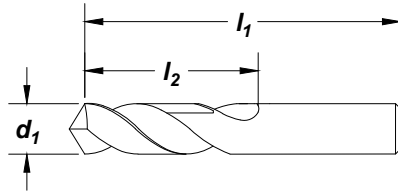

Feature:

Short length design for improved accuracy and rigidity.

drill diameter d_1 fraction wire/let	decimal equiv.	overall length l_1 (in)	flute length l_2 (in)	order no. 2120
60	.0400	1.375	.500	C04356
59	.0410	1.375	.500	C04357
58	.0420	1.375	.500	C04359
57	.0430	1.375	.500	C04360
56	.0465	1.375	.500	C04363
3/64	.0469	1.375	.500	C04364
55	.0520	1.625	.625	C04368
54	.0550	1.625	.625	C04370
53	.0595	1.625	.625	C04374
1/16	.0625	1.625	.625	C04376
52	.0635	1.688	.688	C04378
51	.0670	1.688	.688	C04381
50	.0700	1.688	.688	C04383
49	.0730	1.688	.688	C04386
48	.0760	1.688	.688	C04388
5/64	.0781	1.688	.688	C04390
47	.0785	1.750	.750	C04391
46	.0810	1.750	.750	C04394
45	.0820	1.750	.750	C04395
44	.0860	1.750	.750	C04398
43	.0890	1.750	.750	C04401
42	.0935	1.750	.750	C04404
3/32	.0938	1.750	.750	C04405
41	.0960	1.813	.813	C04407
40	.0980	1.813	.813	C04409
39	.0995	1.813	.813	C04411
38	.1015	1.813	.813	C04412
37	.1040	1.813	.813	C04414
36	.1065	1.813	.813	C04416
7/64	.1094	1.813	.813	C04418
35	.1100	1.875	.875	C04419
34	.1110	1.875	.875	C04421
33	.1130	1.875	.875	C04422
32	.1160	1.875	.875	C04424
31	.1200	1.875	.875	C04426
1/8	.1250	1.875	.875	C04428
30	.1285	1.938	.938	C04431
29	.1360	1.938	.938	C04434
28	.1405	1.938	.938	C04436
9/64	.1406	1.938	.938	C04437

drill diameter d_1 fraction wire/let	decimal equiv.	overall length l_1 (in)	flute length l_2 (in)	order no. 2120
27	.1440	2.063	1.000	C04439
26	.1470	2.063	1.000	C04441
25	.1495	2.063	1.000	C04443
24	.1520	2.063	1.000	C04445
23	.1540	2.063	1.000	C04447
5/32	.1562	2.063	1.000	C04448
22	.1570	2.125	1.063	C04449
21	.1590	2.125	1.063	C04451
20	.1610	2.125	1.063	C04452
19	.1660	2.125	1.063	C04455
18	.1695	2.125	1.063	C04458
11/64	.1719	2.125	1.063	C04459
17	.1730	2.188	1.125	C04460
16	.1770	2.188	1.125	C04462
15	.1800	2.188	1.125	C04464
14	.1820	2.188	1.125	C04466
13	.1850	2.188	1.125	C04467
3/16	.1875	2.188	1.125	C04470
12	.1890	2.250	1.188	C04471
11	.1910	2.250	1.188	C04473
10	.1935	2.250	1.188	C04475
9	.1960	2.250	1.188	C04476
8	.1990	2.250	1.188	C04478
7	.2010	2.250	1.188	C04480
13/64	.2031	2.250	1.188	C04481
6	.2040	2.375	1.250	C04482
5	.2055	2.375	1.250	C04484
4	.2090	2.375	1.250	C04487
3	.2130	2.375	1.250	C04489
7/32	.2188	2.375	1.250	C04491
2	.2210	2.438	1.313	C04493
1	.2280	2.438	1.313	C04496
A	.2340	2.438	1.313	C04499
15/64	.2344	2.438	1.313	C04500
B	.2380	2.500	1.375	C04502
C	.2420	2.500	1.375	C04504
D	.2460	2.500	1.375	C04506
1/4	.2500	2.500	1.375	C04509
F	.2570	2.625	1.438	C04513
G	.2610	2.625	1.438	C04515

continued on next page

Style: 2120 (continued)
General Purpose

drill diameter d ₁	decimal equiv.	overall length l ₁ (in)	flute length l ₂ (in)	order no. 2120
17/64	.2656	2.625	1.438	C04517
H	.2660	2.688	1.500	C04519
I	.2720	2.688	1.500	C04522
J	.2770	2.688	1.500	C04524
K	.2810	2.688	1.500	C04526
9/32	.2812	2.688	1.500	C04531
L	.2900	2.750	1.563	C04530
M	.2950	2.750	1.563	C04533
19/64	.2969	2.750	1.563	C04535
N	.3020	2.813	1.625	C04537
5/16	.3125	2.813	1.625	C04542
O	.3160	2.938	1.688	C04544
P	.3230	2.938	1.688	C04547
21/64	.3281	2.938	1.688	C04550
Q	.3320	3.000	1.688	C04552
R	.3390	3.000	1.688	C04555
11/32	.3438	3.000	1.688	C04557
S	.3480	3.063	1.750	C04560
T	.3580	3.063	1.750	C04563
23/64	.3594	3.063	1.750	C04565
U	.3680	3.125	1.813	C04569
3/8	.3750	3.125	1.813	C04572
V	.3770	3.250	1.875	C04573
W	.3860	3.250	1.875	C04578
25/64	.3906	3.250	1.875	C04580
X	.3970	3.313	1.938	C04582
Y	.4040	3.313	1.938	C04584
13/32	.4062	3.313	1.938	C04585
Z	.4130	3.375	2.000	C04586
27/64	.4219	3.375	2.000	C04588
7/16	.4375	3.438	2.063	C04591
29/64	.4531	3.563	2.125	C04594
15/32	.4688	3.625	2.125	C04596
31/64	.4844	3.688	2.188	C04599
1/2	.5000	3.750	2.250	C04601
33/64	.5156	3.875	2.375	C04604

drill diameter d ₁	decimal equiv.	overall length l ₁ (in)	flute length l ₂ (in)	order no. 2120
17/32	.5312	3.875	2.375	C04606
35/64	.5469	4.000	2.500	C04609
9/16	.5625	4.000	2.500	C04612
37/64	.5781	4.125	2.625	C04614
19/32	.5938	4.125	2.625	C04617
39/64	.6094	4.250	2.750	C04619
5/8	.6250	4.250	2.750	C04622
41/64	.6406	4.500	2.875	C04625
21/32	.6562	4.500	2.875	C04627
43/64	.6719	4.625	2.875	C04630
11/16	.6875	4.625	2.875	C04632
45/64	.7031	4.750	3.000	C04634
23/32	.7188	4.750	3.000	C04636
47/64	.7344	5.000	3.125	C04638
3/4	.7500	5.000	3.125	C04640
49/64	.7656	5.125	3.250	C04641
25/32	.7812	5.125	3.250	C04643
51/64	.7969	5.250	3.375	C04645
13/16	.8125	5.250	3.375	C04647
53/64	.8281	5.375	3.500	C04649
27/32	.8438	5.375	3.500	C04650
55/64	.8594	5.500	3.500	C04652
7/8	.8750	5.500	3.500	C04654
57/64	.8906	5.625	3.625	C04656
29/32	.9062	5.625	3.625	C04658
59/64	.9219	5.750	3.750	C04659
15/16	.9375	5.750	3.750	C04661
61/64	.9531	5.875	3.875	C04663
31/32	.9688	5.875	3.875	C04665
63/64	.9844	6.000	4.000	C04667
1	1.0000	6.000	4.000	C04668
1-1/16*	1.0625	6.250	4.000	C04675
1-1/8*	1.1250	6.375	4.000	C04683
1-3/16*	1.1875	6.625	4.250	C04690
1-1/4*	1.2500	6.750	4.375	C04697

* 1-1/16" through 1-1/4" drills have 1" shank.

Screw Machine Length
High Speed Steel

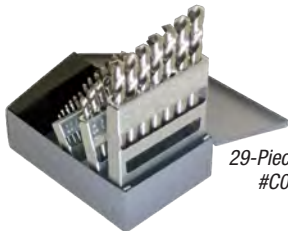
SET
Style: 2120
General Purpose

29-Piece Set
#C00980

no. of pieces	surface treatment	size range	order number 2120
29	Bright	1/16" through 1/2" x 1/64"	C00980
26	Bright	letter A through Z	C01332

Material Reference	Steel (HRC)		Stainless Steel			Cast Iron (HRC)		Aluminum and Non-Ferrous	Hi-Temp Alloy		Hardened Steel (HRC)
	Low Carbon	Alloy	Austenitic	Martensitic	PH	Gray	Nodular		Ni, Co, Fe Based Super Alloy	Titanium	
	Hardness	13-38	>38	16-38	> 38	300 Series	400 series		18-22	22-32	
Bright	☆		☆					☆			

☆ = Best Performance ◆ = Acceptable

Note
Operating parameters: See Technical section

ASME
B94.11M

M42
Cobalt

135° Split

Helix
High
35° to 45°

Straight
Shank

Surface
Treatment

Straw
Oxide

TiN

TiCN

TiAlN

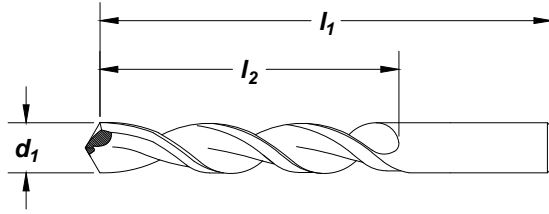

Feature:

Effective deep hole drilling in a wide array of materials. Available coating for extended tool life and productivity. Shorter design for accuracy and rigidity.

Cobalt Screw Machine Length

drill diameter		decimal equivalent	overall length l ₁ (in)	flute length l ₂ (in)	order number			
fraction	d ₁ wire/letter				2175 straw oxide	2175-TN TiN	2175-TC TiCN	2175-TA TiAlN
1/16		.0625	1.625	.625	C14200	C14321	C15250	C15050
	52	.0635	1.688	.688	C14318	C14439	-	-
	51	.0670	1.688	.688	C14317	C14438	-	-
	50	.0700	1.688	.688	C14316	C14437	-	-
	49	.0730	1.688	.688	C14315	C14436	-	-
	48	.0760	1.688	.688	C14314	C14435	-	-
5/64		.0781	1.688	.688	C14201	C14322	C15251	C15051
	47	.0785	1.750	.750	C14313	C14434	-	-
	46	.0810	1.750	.750	C14312	C14433	-	-
	45	.0820	1.750	.750	C14311	C14432	-	-
	44	.0860	1.750	.750	C14310	C14431	-	-
	43	.0890	1.750	.750	C14309	C14430	-	-
	42	.0935	1.750	.750	C14308	C14429	-	-
3/32		.0938	1.750	.750	C14202	C14323	C15252	C15052
	41	.0960	1.813	.813	C14307	C14428	-	-
	40	.0980	1.813	.813	C14280	C14402	C15330	C15130
	39	.0995	1.813	.813	C14279	C14401	C15329	C15129
	38	.1015	1.813	.813	C14278	C14400	C15328	C15128
	37	.1040	1.813	.813	C14277	C14399	C15327	C15127
	36	.1065	1.813	.813	C14276	C14398	C15326	C15126
7/64		.1094	1.813	.813	C14203	C14324	C15253	C15053
	35	.1100	1.875	.875	C14275	C14397	C15325	C15125
	34	.1110	1.875	.875	C14274	C14396	C15324	C15124
	33	.1130	1.875	.875	C14273	C14395	C15323	C15123
	32	.1160	1.875	.875	C14272	C14393	C15322	C15122
	31	.1200	1.875	.875	C14271	C14392	C15321	C15121
1/8		.1250	1.875	.875	C14204	C14325	C15254	C15054
	30	.1285	1.938	.938	C14270	C14391	C15320	C15120
	29	.1360	1.938	.938	C14269	C14390	C15319	C15119
	28	.1405	1.938	.938	C14268	C14389	C15318	C15118
9/64		.1406	1.938	.938	C14205	C14326	C15255	C15055
	27	.1440	2.063	1.000	C14267	C14388	C15317	C15117
	26	.1470	2.063	1.000	C14266	C14387	C15316	C15116
	25	.1495	2.063	1.000	C14265	C14386	C15315	C15115
	24	.1520	2.063	1.000	C14264	C14385	C15314	C15114
	23	.1540	2.063	1.000	C14263	C14384	C15313	C15113
5/32		.1562	2.063	1.000	C14206	C14327	C15256	C15056
	22	.1570	2.125	1.063	C14262	C14383	C15312	C15112
	21	.1590	2.125	1.063	C14261	C14382	C15311	C15111
	20	.1610	2.125	1.063	C14260	C14381	C15310	C15110
	19	.1660	2.125	1.063	C14259	C14380	C15309	C15109
	18	.1695	2.125	1.063	C14258	C14379	C15308	C15108
11/64		.1719	2.125	1.063	C14207	C14328	C15257	C15057

continued on next page

drill diameter		decimal equivalent	overall length l ₁ (in)	flute length l ₂ (in)	order number			
fraction	d ₁ wire/letter				2175 straw oxide	2175-TN TiN	2175-TC TiCN	2175-TA TiAlN
	17	.1730	2.188	1.125	C14257	C14378	C15307	C15107
	16	.1770	2.188	1.125	C14256	C14377	C15306	C15106
	15	.1800	2.188	1.125	C14255	C14376	C15305	C15105
	14	.1820	2.188	1.125	C14254	C14375	C15304	C15104
	13	.1850	2.188	1.125	C14253	C14374	C15303	C15103
3/16		.1875	2.188	1.125	C14208	C14329	C15258	C15058
	12	.1890	2.250	1.188	C14252	C14373	C15302	C15102
	11	.1910	2.250	1.188	C14251	C14372	C15301	C15101
	10	.1935	2.250	1.188	C14250	C14371	C15300	C15100
	9	.1960	2.250	1.188	C14249	C14370	C15299	C15099
	8	.1990	2.250	1.188	C14248	C14369	C15298	C15098
	7	.2010	2.250	1.188	C14247	C14368	C15297	C15097
13/64		.2031	2.250	1.188	C14209	C14330	C15259	C15059
	6	.2040	2.375	1.250	C14246	C14367	C15296	C15096
	5	.2055	2.375	1.250	C14245	C14366	C15295	C15095
	4	.2090	2.375	1.250	C14244	C14365	C15294	C15094
	3	.2130	2.375	1.250	C14243	C14364	C15293	C15093
7/32		.2188	2.375	1.250	C14210	C14331	C15260	C15060
	2	.2210	2.438	1.313	C14242	C14363	C15292	C15092
	1	.2280	2.438	1.313	C14241	C14362	C15291	C15091
15/64	A	.2340	2.438	1.313	C14281	C14403	C15331	C15131
		.2344	2.438	1.313	C14211	C14332	C15261	C15061
	B	.2380	2.500	1.375	C14282	C14404	C15332	C15132
	C	.2420	2.500	1.375	C14283	C14405	C15333	C15133
	D	.2460	2.500	1.375	C14284	C14406	C15334	C15134
1/4	E	.2500	2.500	1.375	C14212	C14333	C15262	C15062
	F	.2570	2.625	1.438	C14286	C14407	C15335	C15135
	G	.2610	2.625	1.438	C14287	C14408	C15336	C15136
17/64		.2656	2.625	1.438	C14213	C14334	C15263	C15063
	H	.2660	2.688	1.500	C14288	C14409	C15337	C15137
	I	.2720	2.688	1.500	C14289	C14410	C15338	C15138
	J	.2770	2.688	1.500	C14290	C14411	C15339	C15139
	K	.2810	2.688	1.500	C14291	C14412	C15340	C15140
9/32		.2812	2.688	1.500	C14214	C14335	C15264	C15064
	L	.2900	2.750	1.563	C14292	C14413	C15341	C15141
	M	.2950	2.750	1.563	C14293	C14414	C15342	C15142
19/64		.2969	2.750	1.563	C14215	C14336	C15265	C15065
	N	.3020	2.813	1.625	C14294	C14415	C15343	C15143
5/16		.3125	2.813	1.625	C14216	C14337	C15266	C15066
	O	.3160	2.938	1.688	C14295	C14416	C15344	C15144
	P	.3230	2.938	1.688	C14296	C14417	C15345	C15145
21/64		.3281	2.938	1.688	C14217	C14338	C15267	C15067
	Q	.3320	3.000	1.688	C14297	C14418	C15346	C15146
	R	.3390	3.000	1.688	C14298	C14419	C15347	C15147
11/32		.3438	3.000	1.688	C14218	C14339	C15268	C15068

continued on next page

Material Reference	Steel (HRC)				Stainless Steel			Cast Iron (HRC)		Aluminum and Non-Ferrous	Hi-Temp Alloy		Hardened Steel (HRC)
	Low Carbon		Alloy		Austenitic	Martensitic	PH	Gray	Nodular		Ni, Co, Fe Based Super Alloy	Titanium	
Hardness	13-38	>38	16-38	> 38	300 Series	400 series		18-22	22-32			>45	
TiN	★		★										
TiCN	☆		☆		★	★		★	★	☆			
TiAlN					☆	☆		☆	☆				

☆ = Best Performance ★ = Acceptable



Screw Machine Length

Cobalt

fraction	drill diameter		decimal equivalent	overall length l ₁ (in)	flute length l ₂ (in)	order number			
	d ₁	wire/letter				2175 straw oxide	2175-TN TiN	2175-TC TiCN	2175-TA TiAlN
		S	.3480	3.063	1.750	C14299	C14420	C15348	C15148
		T	.3580	3.063	1.750	C14300	C14421	C15349	C15149
23/64			.3594	3.063	1.750	C14219	C14340	C15269	C15069
		U	.3680	3.125	1.813	C14301	C14422	C15350	C15150
3/8			.3750	3.125	1.813	C14220	C14341	C15270	C15070
		V	.3770	3.250	1.875	C14302	C14423	C15351	C15151
		W	.3860	3.250	1.875	C14303	C14424	C15352	C15152
25/64			.3906	3.250	1.875	C14221	C14342	C15271	C15071
		X	.3970	3.313	1.938	C14304	C14425	C15353	C15153
		Y	.4040	3.313	1.938	C14305	C14426	C15354	C15154
13/32			.4062	3.313	1.938	C14222	C14343	C15272	C15072
		Z	.4130	3.375	2.000	C14306	C14427	C15355	C15155
27/64			.4219	3.375	2.000	C14223	C14344	C15273	C15073
7/16			.4375	3.438	2.063	C14224	C14345	C15274	C15074
29/64			.4531	3.563	2.125	C14225	C14346	C15275	C15075
15/32			.4688	3.625	2.125	C14226	C14347	C15276	C15076
31/64			.4844	3.688	2.188	C14227	C14348	C15277	C15077
1/2			.5000	3.750	2.250	C14228	C14349	C15278	C15078
33/64			.5156	3.875	2.375	C14229	C14350	C15279	C15079
17/32			.5312	3.875	2.375	C14230	C14351	C15280	C15080
35/64			.5469	4.000	2.500	C14231	C14352	C15281	C15081
9/16			.5625	4.000	2.500	C14232	C14353	C15282	C15082
37/64			.5781	4.125	2.625	C14233	C14354	C15283	C15083
19/32			.5938	4.125	2.625	C14234	C14355	C15284	C15084
39/64			.6094	4.250	2.750	C14235	C14356	C15285	C15085
5/8			.6250	4.250	2.750	C14236	C14357	C15286	C15086
41/64			.6406	4.500	2.875	C14237	C14358	C15287	C15087
21/32			.6562	4.500	2.875	C14238	C14359	C15288	C15088
43/64			.6719	4.625	2.875	C14239	C14360	C15289	C15089
11/16			.6875	4.625	2.875	C14240	C14361	C15290	C15090

Material Reference	Steel (HRC)				Stainless Steel			Cast Iron (HRc)		Aluminum and Non-Ferrous	Hi-Temp Alloy		Hardened Steel (HRc)
	Low Carbon		Alloy		Austenitic	Martensitic	PH	Gray	Nodular		Ni, Co, Fe Based Super Alloy	Titanium	
Hardness	13-38	>38	16-38	> 38	300 Series	400 series		18-22	22-32				>45
TiN	◆		◆										
TiCN	☆		☆		◆	◆		◆	◆	☆			
TiAlN					☆	☆		☆	☆				

☆ = Best Performance ◆ = Acceptable



Style: 2330

Note
 Operating parameters: See Technical section

 NAS 907
 TYPE C

HSS

 135° Split

 Helix
 Regular
 21° to 34°

 Straight
 Shank

 Surface
 Treatment

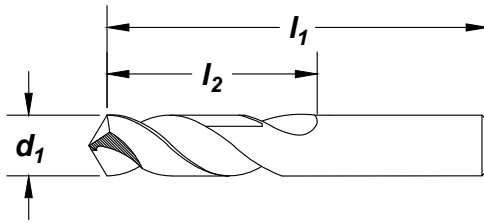
 Bright

Screw Machine Length

High Speed Steel

Feature:

Heavy duty design for tougher materials.

drill diameter		wire	decimal equivalent	overall length		flute length		order number
fraction	d ₁			l ₁ (in)	l ₂ (in)	2330		
*3/64			.0469	1.375	.500		C70250	
1/16			.0625	1.625	.625		C70251	
		52	.0635	1.688	.688		C70356	
		51	.0670	1.688	.688		C70355	
		50	.0700	1.688	.688		C70354	
		49	.0730	1.688	.688		C70353	
		48	.0760	1.688	.688		C70352	
5/64			.0781	1.688	.688		C70252	
		47	.0785	1.750	.750		C70351	
		46	.0810	1.750	.750		C70350	
		45	.0820	1.750	.750		C70349	
		44	.0860	1.750	.750		C70348	
		43	.0890	1.750	.750		C70347	
		42	.0935	1.750	.750		C70346	
3/32			.0938	1.750	.750		C70253	
		41	.0960	1.813	.813		C70345	
		40	.0980	1.813	.813		C70344	
		39	.0995	1.813	.813		C70343	
		38	.1015	1.813	.813		C70342	
		37	.1040	1.813	.813		C70341	
		36	.1065	1.813	.813		C70340	
7/64			.1094	1.813	.813		C70254	
		35	.1100	1.875	.875		C70339	
		34	.1110	1.875	.875		C70338	
		33	.1130	1.875	.875		C70337	
		32	.1160	1.875	.875		C70336	
		31	.1200	1.875	.875		C70335	
1/8			.1250	1.875	.875		C70255	
		30	.1285	1.938	.938		C70334	
		29	.1360	1.938	.938		C70333	
		28	.1405	1.938	.938		C70332	
9/64			.1406	1.938	.938		C70256	

*Not split point.

continued on next page

Material Reference	Steel (HRC)				Stainless Steel			Cast Iron (HRC)		Aluminum and Non-Ferrous	Hi-Temp Alloy		Hardened Steel (HRC)
	Low Carbon		Alloy		Austenitic	Martensitic	PH	Gray	Nodular		Ni, Co, Fe Based Super Alloy	Titanium	
	Hardness	13-38	>38	16-38	> 38	300 Series	400 series		18-22	22-32			>45
Bright	☆		☆		◆				☆	☆	◆		

☆ = Best Performance ◆ = Acceptable



Screw Machine Length

High Speed Steel

fraction	drill diameter		decimal equivalent	overall length		flute length		order number
	d ₁	wire		l ₁ (in)	l ₂ (in)	l ₁ (in)	l ₂ (in)	2330
		27	.1440	2.063	1.000			C70331
		26	.1470	2.063	1.000			C70330
		25	.1495	2.063	1.000			C70329
		24	.1520	2.063	1.000			C70328
		23	.1540	2.063	1.000			C70327
5/32			.1562	2.063	1.000			C70257
		22	.1570	2.125	1.063			C70326
		21	.1590	2.125	1.063			C70325
		20	.1610	2.125	1.063			C70324
		19	.1660	2.125	1.063			C70323
		18	.1695	2.125	1.063			C70322
11/64			.1719	2.125	1.063			C70258
		17	.1730	2.188	1.125			C70321
		16	.1770	2.188	1.125			C70320
		15	.1800	2.188	1.125			C70319
		14	.1820	2.188	1.125			C70318
		13	.1850	2.188	1.125			C70317
3/16			.1875	2.188	1.125			C70259
		12	.1890	2.250	1.188			C70316
		11	.1910	2.250	1.188			C70315
		10	.1935	2.250	1.188			C70314
		9	.1960	2.250	1.188			C70313
		8	.1990	2.250	1.188			C70312
		7	.2010	2.250	1.188			C70311
13/64			.2031	2.250	1.188			C70260
		6	.2040	2.375	1.250			C70310
		5	.2055	2.375	1.250			C70309
		4	.2090	2.375	1.250			C70308
		3	.2130	2.375	1.250			C70307
7/32			.2188	2.375	1.250			C70261
		2	.2210	2.438	1.313			C70306
		1	.2280	2.438	1.313			C70305
		A	.2340	2.438	1.313			C70280
15/64			.2344	2.438	1.313			C70262
		B	.2380	2.500	1.375			C70281
		C	.2420	2.500	1.375			C70282
		D	.2460	2.500	1.375			C70283
1/4			.2500	2.500	1.375			C70263
		E	.2500	2.500	1.375			C70263
		F	.2570	2.625	1.438			C70284
		G	.2610	2.625	1.438			C70285
17/64			.2656	2.625	1.438			C70264
		H	.2660	2.688	1.500			C70286
		I	.2720	2.688	1.500			C70287
		J	.2770	2.688	1.500			C70288
9/32			.2812	2.688	1.500			C70265
		K	.2812	2.688	1.500			C70289
		L	.2900	2.750	1.563			C70290
		M	.2950	2.750	1.563			C70291
19/64			.2969	2.750	1.563			C70266
		N	.3020	2.813	1.625			C70292
5/16			.3125	2.813	1.625			C70267
		O	.3160	2.813	1.688			C70293
		P	.3230	2.813	1.688			C70294
21/64			.3281	2.813	1.688			C70268
		Q	.3320	3.000	1.688			C70295
		R	.3390	3.000	1.688			C70296
11/32			.3438	3.000	1.688			C70269
		S	.3480	3.063	1.750			C70297

continued on next page



Style: 2330 (continued)
Aircraft NAS 907, Type C
Heavy Duty

drill diameter		wire	decimal equivalent	overall length l ₁ (in)	flute length l ₂ (in)	order number 2330
fraction	d ₁					
23/64		T	.3580	3.063	1.750	C70298
			.3594	3.063	1.750	C70270
		U	.3680	3.125	1.813	C70299
3/8			.3750	3.125	1.813	C70271
		V	.3770	3.250	1.875	C70300
		W	.3860	3.250	1.875	C70301
25/64			.3906	3.250	1.875	C70272
		X	.3970	3.313	1.938	C70302
		Y	.4040	3.313	1.938	C70303
13/32			.4062	3.313	1.938	C70273
		Z	.4130	3.375	2.000	C70304
27/64			.4219	3.375	2.000	C70274
7/16			.4375	3.438	2.063	C70275
29/64			.4531	3.563	2.125	C70276
15/32			.4688	2.625	2.125	C70277
31/64			.4844	3.688	2.188	C70278
1/2			.5000	3.750	2.250	C70279

Screw Machine Length
High Speed Steel
SET
Style: 2330
Aircraft NAS 907, Type C
Heavy Duty

*29-Piece Set
#C70368*

no. of pieces	surface treatment	size range	order number
			2330
15	Bright	1/16" through 1/2" x 1/32"	C70370
21	Bright	1/16" through 3/8" x 1/64"	C70369
29	Bright	1/16" through 1/2" x 1/64"	C70368

Material Reference	Steel (HRC)				Stainless Steel			Cast Iron (HRC)		Aluminum and Non-Ferrous	Hi-Temp Alloy		Hardened Steel (HRC)
	Low Carbon		Alloy		Austenitic	Martensitic	PH	Gray	Nodular		Ni, Co, Fe Based Super Alloy	Titanium	
	Hardness	13-38	>38	16-38	> 38	300 Series	400 series		18-22	22-32			>45
Bright	☆		☆		◆			☆	☆	◆			

☆ = Best Performance ◆ = Acceptable

Note
Operating parameters: See Technical section

ASME
B94.11M

DIN
1897

M42
Cobalt

135° Split

Helix
Regular
21° to 34°

Straight
Shank

Surface
Treatment

Straw
Oxide

TiCN

Screw Machine Length

Cobalt

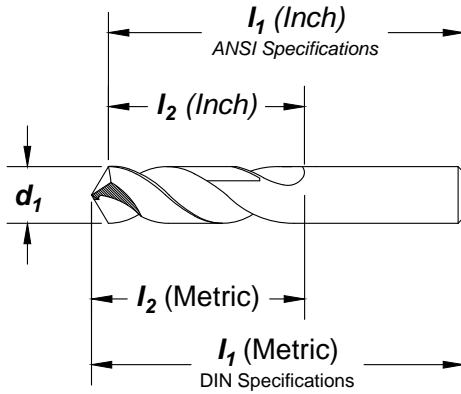

Feature:

Highly heat resistant substrate for tough to machine materials.

drill diameter			overall length		flute length		order number		
fraction	wire/letter	mm	decimal equivalent	in	mm	in	mm	2133 straw oxide	2133-TC TiCN
	*60		.0400	1.375		.500		C14501	—
	*59		.0410	1.375		.500		C14502	—
	*58		.0420	1.375		.500		C14504	—
	*57		.0430	1.375		.500		C14505	—
	*56		.0465	1.375		.500		C14508	—
*3/64			.0469	1.375		.500		C14509	—
		*1.2	.0472		30.00		8.00	C14835	—
	*55		.0520	1.625		.625		C14513	—
	*54		.0550	1.625		.625		C14515	—
		*1.5	.0591		32.00		9.00	C14838	—
	*53		.0595	1.625		.625		C14519	—
1/16			.0625	1.625		.625		C14521	C14846
		1.6	.0630		34.00		10.00	C14748	—
	52		.0635	1.688		.688		C14523	—
	51		.0670	1.688		.688		C14526	—
	50		.0700	1.688		.688		C14528	—
	49		.0730	1.688		.688		C14531	—
	48		.0760	1.688		.688		C14533	—
5/64			.0781	1.688		.688		C14535	—
	47		.0785	1.750		.750		C14536	—
		2.0	.0787		38.00		12.00	C14800	C14749
	46		.0810	1.750		.750		C14539	—
	45		.0820	1.750		.750		C14540	—
	44		.0860	1.750		.750		C14543	—
	43		.0890	1.750		.750		C14546	—
	42		.0935	1.750		.750		C14549	—
3/32			.0938	1.750		.750		C14550	C14848
		2.4	.0945		43.00		14.00	C14790	—
	41		.0960	1.813		.813		C14552	—
	40		.0980	1.813		.813		C14554	—
		2.5	.0984	1.693	43.00	.551	14.00	C14820	C14750

*Not split point.

continued on next page

TECH TIP

Benefits of 2133 Cobalt Screw Machine Drill

- Cobalt provides high heat resistance for tough applications.
- Short flutes provide enhanced rigidity and drill more accurate holes.

Styles: 2133, 2133-TC (continued)

drill diameter		overall length				flute length		order number	
fraction	d1 wire/letter	mm	decimal equivalent	in	mm	in	mm	2133 straw oxide	2133-TC TiCN
	39		.0995	1.813		.813		C14556	-
	38		.1015	1.813		.813		C14557	-
		2.6	.1024	1.693	43.00	.551	14.00	C14840	C14730
	37		.1040	1.813		.813		C14559	-
	36		.1065	1.813		.813		C14561	-
7/64			.1094	1.813		.813		C14562	-
	35		.1100	1.875		.875		C14563	-
		2.8	.1102		46.00		16.00	C14841	-
	34		.1110	1.875		.875		C14565	-
	33		.1130	1.875		.875		C14566	-
	32		.1160	1.875		.875		C14568	-
		3.0	.1181		46.00		16.00	C14821	C14751
	31		.1200	1.875		.875		C14570	-
		3.1	.1220		49.00		18.00	C14822	C14752
1/8			.1250	1.875		.875		C14572	C14850
		3.2	.1260		49.00		18.00	C14801	C14753
	30		.1285	1.938		.938		C14574	-
		3.3	.1299		49.00		18.00	C14802	C14754
	29		.1360	1.938		.938		C14577	-
		3.5	.1378		52.00		20.00	C14803	C14755
	28		.1405	1.938		.938		C14579	-
9/64			.1406	1.938		.938		C14580	-
	27		.1440	2.063		1.000		C14582	-
		3.7	.1457		52.00		20.00	C14823	-
	26		.1470	2.063		1.000		C14584	-
	25		.1495	2.063		1.000		C14585	-
	24		.1520	2.063		1.000		C14587	-
	23		.1540	2.063		1.000		C14589	-
5/32			.1562	2.063		1.000		C14590	C14852
	22		.1570	2.125		1.063		C14591	-
		4.0	.1575		55.00		22.00	C14824	C14756
	21		.1590	2.125		1.063		C14593	-
	20		.1610	2.125		1.063		C14594	-
		4.1	.1614		55.00		22.00	C14825	C14757
		4.2	.1654		55.00		22.00	C14804	C14758
	19		.1660	2.125		1.063		C14597	-
	18		.1695	2.125		1.063		C14599	-
11/64			.1719	2.125		1.063		C14600	-
	17		.1730	2.188		1.125		C14601	-
	16		.1770	2.188		1.125		C14603	-
		4.5	.1772		58.00		24.00	C14805	C14759
	15		.1800	2.188		1.125		C14605	-
		4.6	.1811		58.00		24.00	C14842	C14728
	14		.1820	2.188		1.125		C14607	-
	13		.1850	2.188		1.125		C14608	-
3/16			.1875	2.188		1.125		C14610	C14854
		4.8	.1890		62.00		26.00	C14806	C14760
	12		.1890	2.250		1.188		C14611	-
	11		.1910	2.250		1.188		C14613	-

continued on next page

Material Reference	Steel (HRC)				Stainless Steel			Cast Iron (HRC)		Aluminum and Non-Ferrous	Hi-Temp Alloy		Hardened Steel (HRC)
	Low Carbon		Alloy		Austenitic	Martensitic	PH	Gray	Nodular		Ni, Co, Fe Based Super Alloy	Titanium	
	Hardness	13-38	>38	16-38	> 38	300 Series	400 series		18-22	22-32			>45
Straw	◆		◆		◆	◆		◆	◆				
TiCN	☆		☆		☆	☆		☆	☆	☆	◆	◆	

☆ = Best Performance ◆ = Acceptable



Screw Machine Length

Cobalt

fraction	drill diameter		decimal equivalent	overall length		flute length		order number	
	wire/letter	d ₁ mm		l ₁ in	mm	l ₂ in	mm	2133 straw oxide	2133-TC TiCN
		4.9	.1929		62.00		26.00	C14826	-
	10		.1935	2.250		1.188		C14615	-
	9		.1960	2.250		1.188		C14616	-
		5.0	.1969		62.00		26.00	C14827	C14761
	8		.1990	2.250		1.188		C14618	-
		5.1	.2008		62.00		26.00	C14807	C14762
	7		.2010	2.250		1.188		C14620	-
13/64			.2031	2.250		1.188		C14621	-
	6		.2040	2.375		1.250		C14622	-
	5		.2055	2.375		1.250		C14624	-
	4		.2090	2.375		1.250		C14626	-
	3		.2130	2.375		1.250		C14628	-
		5.5	.2165		66.00		28.00	C14828	C14786
7/32			.2188	2.375		1.250		C14630	C14856
		5.6	.2205		66.00		28.00	C14843	-
	2		.2210	2.438		1.313		C14632	-
		5.7	.2244		66.00		28.00	C14844	-
	1		.2280	2.438		1.313		C14634	-
	A		.2340	2.438		1.313		C14637	-
15/64			.2344	2.438		1.313		C14638	-
		6.0	.2362		66.00		28.00	C14829	C14763
	B		.2380	2.500		1.375		C14640	-
		6.1	.2402		70.00		31.00	C14869	-
	C		.2420	2.500		1.375		C14642	-
	D		.2460	2.500		1.375		C14644	-
1/4, E	E		.2500	2.500		1.375		C14646	C14858
		6.5	.2559		70.00		31.00	C14808	C14764
	F		.2570	2.625		1.438		C14649	-
		6.6	.2598		70.00		31.00	C14809	-
	G		.2610	2.625		1.438		C14651	-
17/64			.2656	2.625		1.438		C14653	-
	H		.2660	2.688		1.500		C14654	-
		6.8	.2677		74.00		34.00	C14810	C14765
	I		.2720	2.688		1.500		C14657	-
		7.0	.2756		74.00		34.00	C14830	C14766
	J		.2770	2.688		1.500		C14659	-
	K		.2810	2.688		1.500		C14661	-
9/32			.2812	2.688		1.500		C14664	C14860
	L		.2900	2.750		1.563		C14665	-
		7.4	.2913		74.00		34.00	C14811	-
	M		.2950	2.750		1.563		C14667	-
		7.5	.2953		74.00		34.00	C14831	C14787
19/64			.2969	2.750		1.563		C14669	-
	N		.3020	2.813		1.625		C14671	-
5/16			.3125	2.813		1.625		C14675	C14861
		8.0	.3150		79.00		37.00	C14812	C14767
	O		.3160	2.938		1.688		C14677	-
		8.1	.3189		79.00		37.00	C14670	-
	P		.3230	2.938		1.688		C14680	-
21/64			.3281	2.938		1.688		C14682	-
	Q		.3320	3.000		1.688		C14684	-
		8.5	.3346		79.00		37.00	C14813	C14768
	R		.3390	3.000		1.688		C14687	-
11/32			.3438	3.000		1.688		C14689	C14862
	S		.3480	3.063		1.750		C14691	-
		9.0	.3543		84.00		40.00	C14814	C14769

continued on next page



Styles: 2133, 2133-TC (continued)

drill diameter		decimal		overall length		flute length		order number	
fraction	d ₁ wire/letter	mm	equivalent	in	mm	in	mm	2133 straw oxide	2133-TC TiCN
23/64	T		.3580	3.063		1.750		C14694	–
			.3594	3.063		1.750		C14696	–
	U		.3680	3.125		1.813		C14699	–
3/8		9.5	.3740		84.00		40.00	–	C14770
			.3750	3.125		1.813		C14702	C14863
	V		.3770	3.250		1.875		C14703	–
25/64	W		.3860	3.250		1.875		C14707	–
			.3906	3.250		1.875		C14709	–
		10.0	.3937		89.00		43.00	C14815	C14771
13/32	X		.3970	3.313		1.938		C14711	–
	Y		.4040	3.313		1.938		C14713	–
			.4062	3.313		1.938		C14715	C14864
27/64	Z		.4130	3.375		2.000		C14716	–
		10.5	.4134		89.00		43.00	C14816	C14788
			.4219	3.375		2.000		C14718	–
7/16			.4331		95.00		47.00	C14817	C14772
			.4375	3.438		2.063		C14721	C14865
		11.0	.4375		95.00		47.00	C14832	C14773
29/64			.4528		95.00		47.00	C14832	C14773
			.4531	3.563		2.125		C14724	–
			.4688	3.625		2.125		C14726	C14867
15/32		12.0	.4724		102.00		51.00	C14818	C14774
			.4844	3.688		2.188		C14729	–
		12.5	.4921		102.00		51.00	C14819	C14775
1/2			.5000	3.750		2.250		C14731	C14866

Screw Machine Length
Cobalt

Material Reference	Steel (HRc)				Stainless Steel			Cast Iron (HRc)		Aluminum and Non-Ferrous	Hi-Temp Alloy		Hardened Steel (HRc)
	Low Carbon		Alloy		Austenitic	Martensitic	PH	Gray	Nodular		Ni, Co, Fe Based Super Alloy	Titanium	
Hardness	13-38	>38	16-38	> 38	300 Series	400 series		18-22	22-32				>45
Straw	◆		◆		◆	◆		◆	◆				
TiCN	☆		☆		☆	☆		☆	☆	☆	◆	◆	

☆ = Best Performance ◆ = Acceptable

Spade Drill

Style: 1765

Surface Treatment

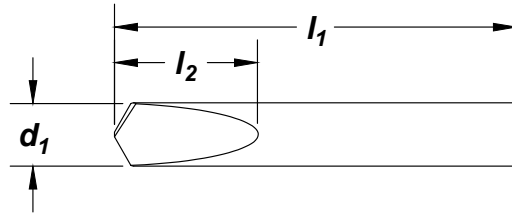
Stub Length
Carbide

cutting diameter d₁ fraction	decimal equivalent	overall length l₁	flute length l₂	order number 1765
1/32	.0313	1-1/2	3/16	C89705
1/16	.0625	1-1/2	5/16	C89706
3/32	.0938	1-1/2	3/8	C89707
1/8	.1250	1-1/2	7/16	C89708
5/32	.1562	2	15/32	C89709
3/16	.1875	2	9/16	C89710
7/32	.2188	2	19/32	C89711
1/4	.2500	2	11/16	C89712
9/32	.2812	2-1/2	3/4	C89714
5/16	.3125	2-1/2	7/8	C89715
11/32	.3438	2-1/2	15/16	C89716
3/8	.3750	2-1/2	1-1/16	C89713

Material Reference	Steel (HRC)				Stainless Steel			Cast Iron (HRC)		Aluminum and Non-Ferrous	Hi-Temp Alloy		Hardened Steel (HRC)
	Low Carbon		Alloy		Austenitic	Martensitic	PH	Gray	Nodular		Ni, Co, Fe Based Super Alloy	Titanium	
	Hardness	13-38	>38	16-38	> 38	300 Series	400 series		18-22	22-32			>45
Bright	☆	◆	☆	◆	◆			☆	◆				◆

☆ = Best Performance ◆ = Acceptable

Style: 1767
Stub Length

ASME B94.11M	Carbide	118° 4-Facet	Helix Regular 21° to 34°	Straight Shank
-----------------	---------	--------------	--------------------------------	-------------------

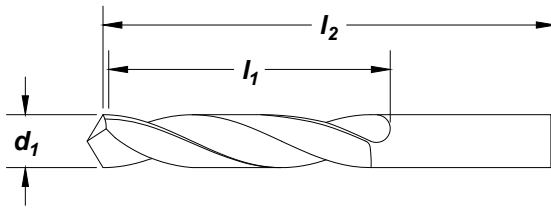
**Surface
Treatment**

Stub Length
Carbide

fraction	cutting diameter d_1		decimal equivalent	overall length l_1	flute length l_2	order number 1767
	wire/let					
		60	.0400	1-1/2	3/8	C89675
		59	.0410	1-1/2	3/8	C89674
		58	.0420	1-1/2	3/8	C89673
		57	.0430	1-1/2	3/8	C89672
		56	.0465	1-1/2	3/8	C89671
		55	.0520	1-1/2	3/8	C89670
		54	.0550	1-1/2	3/8	C89669
		53	.0595	1-1/2	3/8	C89668
1/16			.0625	2	5/8	C89676
		52	.0635	2	5/8	C89667
		51	.0670	2	5/8	C89666
		50	.0700	2	5/8	C89665
		49	.0730	2	5/8	C89664
		48	.0760	2	5/8	C89663
5/64			.0781	2	5/8	C89677
		47	.0785	2	5/8	C89662
		46	.0810	2	5/8	C89661
		45	.0820	2	5/8	C89660
		44	.0860	2	5/8	C89659
		43	.0890	2	5/8	C89658
		42	.0935	2	5/8	C89657
3/32			.0938	2	5/8	C89678
		41	.0960	2	5/8	C89656
		40	.0980	2	5/8	C89655
		39	.0995	2	5/8	C89654
		38	.1015	2	5/8	C89653
		37	.1040	2	5/8	C89652
		36	.1065	2	5/8	C89651
7/64			.1094	2	5/8	C89679
		35	.1100	2	5/8	C89650
		34	.1110	2	5/8	C89649
		33	.1130	2	5/8	C89648
		32	.1160	2	5/8	C89647
		31	.1200	2	5/8	C89646
1/8			.1250	2	5/8	C89680
		30	.1285	2	5/8	C89645

continued on next page

Material Reference	Steel (HRC)				Stainless Steel			Cast Iron (HRC)		Aluminum and Non-Ferrous	Hi-Temp Alloy		Hardened Steel (HRC)
	Low Carbon		Alloy		Austenitic	Martensitic	PH	Gray	Nodular		Ni, Co, Fe Based Super Alloy	Titanium	
	Hardness	13-38	>38	16-38	> 38	300 Series	400 series		18-22	22-32			>45
Bright	☆	◆	☆	◆	◆			☆	☆	◆			◆

☆ = Best Performance ◆ = Acceptable

Stub Length

Style: **1767** (continued)

Stub Length

Carbide

fraction	cutting diameter d ₁		decimal equivalent	overall length l ₁	flute length l ₂	order number 1767
	wire/let					
		29	.1360	2	5/8	C89644
9/64			.1406	2	5/8	C89681
		28	.1405	2	5/8	C89643
		27	.1440	2	5/8	C89642
		26	.1470	2	5/8	C89641
		25	.1495	2-1/2	3/4	C89640
		24	.1520	2-1/2	3/4	C89639
		23	.1540	2-1/2	3/4	C89638
5/32			.1562	2-1/2	3/4	C89682
		22	.1570	2-1/2	3/4	C89637
		21	.1590	2-1/2	3/4	C89636
		20	.1610	2-1/2	3/4	C89635
		19	.1660	2-1/2	3/4	C89634
		18	.1695	2-1/2	3/4	C89633
11/64			.1719	2-1/2	3/4	C89683
		17	.1730	2-1/2	3/4	C89632
		16	.1770	2-1/2	3/4	C89631
		15	.1800	2-1/2	3/4	C89630
		14	.1820	2-1/2	3/4	C89629
		13	.1850	2-1/2	3/4	C89628
3/16			.1875	2-1/2	3/4	C89684
		12	.1890	2-1/2	3/4	C89627
		11	.1910	2-1/2	3/4	C89626
		10	.1935	2-1/2	3/4	C89625
		9	.1960	2-1/2	3/4	C89624
		8	.1990	2-1/2	3/4	C89623
		7	.2010	2-1/2	3/4	C89622
13/64			.2031	2-1/2	3/4	C89685
		6	.2040	2-1/2	3/4	C89621
		5	.2055	2-1/2	3/4	C89620
		4	.2090	2-1/2	3/4	C89619
		3	.2130	2-1/2	1	C89618
7/32			.2188	2-1/2	1	C89686
		2	.2210	2-1/2	1	C89617
		1	.2280	2-1/2	1	C89616
15/64			.2344	2-1/2	1	C89687
1/4			.2500	2-1/2	1	C89688
17/64			.2656	2-1/2	1	C89689
9/32			.2812	2-1/2	1	C89690
19/64			.2969	2-3/4	1-1/4	C89691
5/16			.3125	2-3/4	1-1/4	C89692
21/64			.3281	2-3/4	1-1/4	C89693
11/32			.3438	3	1-1/4	C89694
23/64			.3594	3	1-1/4	C89695
3/8			.3750	3	1-1/4	C89696
25/64			.3906	3	1-1/4	C89697
13/32			.4062	3	1-1/4	C89698
27/64			.4219	3	1-1/4	C89699
7/16			.4375	3	1-1/4	C89700
29/64			.4531	3	1-1/4	C89701
15/32			.4688	3	1-1/4	C89702
31/64			.4844	3	1-1/4	C89703
1/2			.5000	3	1-1/4	C89704

Material Reference	Steel (HRC)				Stainless Steel			Cast Iron (HRc)		Aluminum and Non-Ferrous	Hi-Temp Alloy		Hardened Steel (HRc)
	Low Carbon		Alloy		Austenitic	Martensitic	PH	Gray	Nodular		Ni, Co, Fe Based Super Alloy	Titanium	
	Hardness	13-38	>38	16-38	> 38	300 Series	400 series		18-22	22-32			>45
Bright	☆	◆	☆	◆	◆			☆	☆	◆			◆

☆ = Best Performance ◆ = Acceptable

Styles: 2002G, 2001G, 2002G-TC
General Purpose
Note

 Operating parameters:
See Technical section

 ASME
B94.11M

 DIN
338

HSS-E

 118°



 Helix
Regular

 Straight
Shank

 Surface
Treatment

 Bright

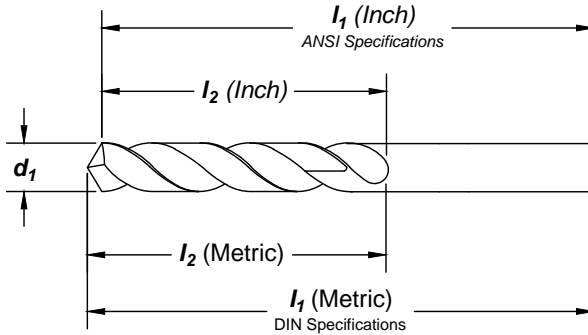
 Black
Oxide

 TiCN

Jobber Length

High Speed Steel

Feature:

General purpose jobber drill with improved geometry. Premium steel substrate.

drill diameter		overall length		flute length		order number		
d ₁		I ₁		I ₂		2002G	2001G	2002G-TC
fraction	wire/letter	decimal	equivalent	in	mm	in	mm	mm
		1.00	.0394		34.00		12.00	
	60		.0400	1.625		.688		
	59		.0410	1.625		.688		
		1.05	.0413		34.00		12.00	
	58		.0420	1.625		.688		
	57		.0430	1.750		.750		
		1.10	.0433		36.00		14.00	
		1.15	.0453		36.00		14.00	
	56		.0465	1.750		.750		
3/64			.0469	1.750		.750		
		1.20	.0472		38.00		16.00	
		1.25	.0492		38.00		16.00	
		1.30	.0512		38.00		16.00	
	55		.0520	1.875		.875		
		1.35	.0531		40.00		18.00	
	54		.0550	1.875		.875		
		1.40	.0551		40.00		18.00	
		1.45	.0571		40.00		18.00	
		1.50	.0591		40.00		18.00	
	53		.0595	1.875		.875		
		1.55	.0610		43.00		20.00	
1/16			.0625	1.875		.875		
		1.60	.0630		43.00		20.00	
	52		.0635	1.875		.875		
		1.65	.0650		43.00		20.00	
		1.70	.0669		43.00		20.00	
	51		.0670	2.000		1.000		
		1.75	.0689		46.00		22.00	

continued on next page

Material Reference	Steel (HRc)				Stainless Steel			Cast Iron (HRc)		Aluminum and Non-Ferrous	Hi-Temp Alloy		Hardened Steel (HRc)
	Low Carbon		Alloy		Austenitic	Martensitic	PH	Gray	Nodular		Ni, Co, Fe Based Super Alloy	Titanium	
	Hardness	13-38	>38	16-38	> 38	300 Series	400 series		18-22	22-32			>45
Bright													
Black Oxide	★				★			★					
TiCN	★		★		★			★		★			

★ = Best Performance ◆ = Acceptable

General Purpose
Styles: 2002G, 2001G, 2002G-TC (continued)
Jobber Length
High Speed Steel

fraction	drill diameter		decimal equivalent	overall length		flute length		order number		
	wire/letter	mm		l ₁	mm	l ₂	mm	2002G bright	2001G black oxide	2002G-TC TiCN
50		1.80	.0700	2.000		1.000		C72150	C71150	C73150
		1.85	.0709		46.00		22.00	C72216	C71216	-
			.0728		46.00		22.00	-	C71217	-
49		1.90	.0730	2.000		1.000		C72149	C71149	C73149
			.0748		46.00		22.00	C72218	C71218	-
48		1.95	.0760	2.000		1.000		C72148	C71148	C73148
			.0767	1.929	49.00	.945	24.00	-	C71219	-
5/64			.0781	2.000	50.80	1.000	25.40	C72005	C71005	C73005
			.0785	2.000	50.80	1.000	25.40	C72147	C71147	C73147
			.0787	1.929	49.00	.945	24.00	C72220	C71220	C73220
46			.0807	1.929	49.00	.945	24.00	-	C71221	-
			.0810	2.125		1.125		C72146	C71146	C73146
			.0820	2.125		1.125		C72145	C71145	C73145
45		2.10	.0827		49.00		24.00	C72222	C71222	-
			.0846		53.00		27.00	-	C71223	-
			.0860	2.125		1.125		C72144	C71144	C73144
44			.0866		53.00		27.00	C72224	C71224	-
			.0886		53.00		27.00	-	C71225	-
			.0890	2.250		1.250		C72143	C71143	C73143
43			.0906		53.00		27.00	C72226	C71226	-
			.0925		53.00		27.00	-	C71227	-
			.0935	2.250		1.250		C72142	C71142	C73142
3/32			.0938	2.250		1.250		C72006	C71006	C73006
		2.40	.0945		57.00		30.00	C72228	C71228	C73228
41			.0960	2.375		1.375		C72141	C71141	C73141
			.0964		57.00		30.00	-	C71229	-
40			.0980	2.375		1.375		C72140	C71140	C73140
		2.50	.0984		57.00		30.00	C72230	C71230	C73230
39			.0995	2.375		1.375		C72139	C71139	C73139
			.1015	2.500		1.438		C72138	C71138	C73138
38		2.60	.1024		57.00		30.00	C72231	C71231	-
			.1040	2.500		1.438		C72137	C71137	C73137
37			.1062		61.00		33.00	C72232	C71232	-
			.1065	2.500		1.438		C72136	C71136	C73136
			.1094	2.625		1.500		C72007	C71007	C73007
7/64			.1100	2.625		1.500		C72135	C71135	C73135
		2.80	.1102		61.00		33.00	C72233	C71233	-
34			.1110	2.625		1.500		C72134	C71134	C73134
			.1130	2.625		1.500		C72133	C71133	C73133
33		2.90	.1142		61.00		33.00	C72234	C71234	-
			.1160	2.750		1.625		C72132	C71132	C73132
32		3.00	.1181		61.00		33.00	C72235	C71235	C73235
			.1200	2.750		1.625		C72131	C71131	C73131
31		3.10	.1220		65.00		36.00	C72236	C71236	-
			.1250	2.750		1.625		C72008	C71008	C73008
			.1260		66.00		37.00	C72237	C71237	C73237
1/8			.1285	2.750		1.625		C72130	C71130	C73130
		3.30	.1299		67.00		38.00	C72238	C71238	C73238
			.1339		70.00		39.00	C72239	C71239	-
29			.1360	2.875		1.750		C72129	C71129	C73129
			.1378		70.00		39.00	C72240	C71240	C73240
28			.1405	2.875		1.750		C72128	C71128	C73128
			.1406	2.875		1.750		C72009	C71009	C73009
9/64		3.60	.1417		70.00		39.00	C72241	C71241	C73241
			.1440	3.000		1.875		C72127	C71127	C73127
27		3.70	.1457		70.00		39.00	C72242	C71242	-
			.1470	3.000		1.875		C72126	C71126	C73126

continued on next page

Styles: 2002G, 2001G, 2002G-TC (continued)
General Purpose

drill diameter		overall length		flute length		order number				
fraction	d ₁ wire/letter	decimal equivalent	l ₁ in	l ₂ in	mm	mm	2002G bright	2001G black oxide	2002G-TC TiCN	
	25	.1495	3.000			1.875	C72125	C71125	C73125	
		3.80	.1496		75.00	43.00	C72243	C71243	-	
	24	.1520	3.125			2.000	C72124	C71124	C73124	
		3.90	.1535		75.00	43.00	C72244	C71244	-	
	23	.1540	3.125			2.000	C72123	C71123	C73123	
5/32		.1562	3.125			2.000	C72010	C71010	C73010	
	22	.1570	3.125			2.000	C72122	C71122	C73122	
		4.00	.1575		75.00	43.00	C72245	C71245	C73245	
	21	.1590	3.250			2.125	C72121	C71121	C73121	
	20	.1610	3.250			2.125	C72120	C71120	C73120	
		4.10	.1614		75.00	43.00	C72246	C71246	C73246	
		4.20	.1654		75.00	43.00	C72247	C71247	C73247	
	19	.1660	3.250			2.125	C72119	C71119	C73119	
		4.30	.1692		80.00	47.00	C72248	C71248	C73248	
	18	.1695	3.250			2.125	C72118	C71118	C73118	
11/64		.1719	3.250			2.125	C72011	C71011	C73011	
	17	.1730	3.375			2.188	C72117	C71117	C73117	
		4.40	.1732		80.00	47.00	C72249	C71249	-	
	16	.1770	3.375			2.188	C72116	C71116	C73116	
		4.50	.1772		80.00	47.00	C72250	C71250	C73250	
	15	.1800	3.375			2.188	C72115	C71115	C73115	
		4.60	.1811			1.850	47.00	C72251	C71251	-
	14	.1820	3.375			2.188	C72114	C71114	C73114	
	13	.1850	3.500			2.313	C72113	C71113	C73113	
		4.70	.1850		80.00	47.00	C72252	C71252	-	
3/16		.1875	3.500			2.313	C72012	C71012	C73012	
	12	.1890	3.500			2.313	C72112	C71112	C73112	
		4.80	.1890		86.00	52.00	C72253	C71253	C73253	
	11	.1910	3.500			2.313	C72111	C71111	C73111	
		4.90	.1929		86.00	52.00	C72254	C71254	C73254	
	10	.1935	3.625			2.438	C72110	C71110	C73110	
	9	.1960	3.625			2.438	C72109	C71109	C73109	
		5.00	.1969		86.00	52.00	C72255	C71255	C73255	
	8	.1990	3.625			2.438	C72108	C71108	C73108	
		5.10	.2008		86.00	52.00	C72256	C71256	C73256	
	7	.2010	3.625			2.438	C72107	C71107	C73107	
13/64		.2031	3.625			2.438	C72013	C71013	C73013	
	6	.2040	3.750			2.500	C72106	C71106	C73106	
		5.20	.2047		86.00	52.00	C72257	C71257	C73257	
	5	.2055	3.750			2.500	C72105	C71105	C73105	
	4	.2090	3.750			2.500	C72104	C71104	C73104	
		5.40	.2125		93.00	57.00	C72259	C71259	-	
	3	.2130	3.750			2.500	C72103	C71103	C73103	
		5.50	.2165		93.00	57.00	C72260	C71260	C73260	
7/32		.2188	3.750			2.500	C72014	C71014	C73014	
		5.60	.2205		93.00	57.00	C72261	C71261	-	
	2	.2210	3.875			2.625	C72102	C71102	C73102	
		5.70	.2244		93.00	57.00	C72262	C71262	-	
	1	.2280	3.875			2.625	C72101	C71101	C73101	

Jobber Length
High Speed Steel
continued on next page

Material Reference	Steel (HRC)				Stainless Steel			Cast Iron (HRC)		Aluminum and Non-Ferrous	Hi-Temp Alloy		Hardened Steel (HRC)
	Low Carbon		Alloy		Austenitic	Martensitic	PH	Gray	Nodular		Ni, Co, Fe Based Super Alloy	Titanium	
	Hardness	13-38	>38	16-38	> 38	300 Series	400 series		18-22	22-32			>45
Bright													
Black Oxide	◆				◆				◆				
TiCN	☆		☆		☆				☆				

☆ = Best Performance ◆ = Acceptable

General Purpose

Styles: **2002G, 2001G, 2002G-TC** (continued)

Jobber Length

High Speed Steel

fraction	drill diameter		decimal equivalent	overall length		flute length		order number			
	wire/letter	mm		in	mm	in	mm	2002G bright	2001G black oxide	2002G-TC TiCN	
15/64	A	5.90	.2322		93.00		57.00	C72264	C71264	-	
		.2340	3.875		2.625			C72071	C71071	C73071	
	B		.2344	3.875		2.625		C72015	C71015	C73015	
			6.00	.2362		93.00		57.00	C72265	C71265	C73265
1/4	C		.2380	4.000		2.750		C72072	C71072	C73072	
			6.10	.2401		101.00		63.00	C72266	C71266	-
	D		.2420	4.000		2.750			C72073	C71073	C73073
			6.20	.2440		101.00		63.00	C72267	C71267	-
9/32	E		.2460	4.000		2.750		C72074	C71074	C73074	
			6.30	.2480		101.00		63.00	C72268	C71268	-
	F		.2500	4.000		2.750			C72016	C71016	C73016
			6.40	.2520		101.00		63.00	C72269	C71269	-
17/64	G		.2559		101.00		63.00	C72270	C71270	C73270	
			6.50	.2570	4.125		2.875		C72076	C71076	C73075
	H		.2598		101.00		63.00	C72271	C71271	-	
			6.60	.2610	4.125		2.875		C72077	C71077	C73076
9/32	I		.2638					C72272	C71272	-	
			6.70	.2656	4.125		2.875		C72017	C71017	C73017
	J		.2660	4.125		2.875			C72078	C71078	C73077
			6.80	.2677		109.00		69.00	C72273	C71273	C73273
19/64	K		.2717		109.00		69.00	C72274	C71274	-	
			6.90	.2720	4.125		2.875		C72079	C71079	C73078
	L		.2756		109.00		69.00	C72275	C71275	C73275	
			7.00	.2770	4.125		2.875		C72080	C71080	C73079
5/16	M		.2795		109.00		69.00	C72276	C71276	-	
			7.10	.2812	4.250		2.938		C72018	C71018	C73018
	N		.2812	4.250		2.938			C72081	C71081	C73080
			7.20	.2835		109.00		69.00	C72277	C71277	-
11/32	O		.2874		109.00		69.00	C72278	C71278	-	
			7.30	.2900	4.250		2.938		C72082	C71082	C73081
	P		.2913		109.00		69.00	C72279	C71279	-	
			7.40	.2933	4.375		3.063		C72083	C71083	C73082
3/8	Q		.2953		109.00		69.00	C72280	C71280	C73280	
			7.50	.2969	4.375		3.063		C72019	C71019	C73019
	R		.3020	4.375		3.063			C72084	C71084	C73083
			7.70	.3031		117.00		75.00	C72282	C71282	-
1/2	S		.3070		117.00		75.00	C72283	C71283	-	
			7.80	.3110		117.00		75.00	C72284	C71284	-
	T		.3125	4.500		3.188			C72020	C71020	C73020
			8.00	.3150		117.00		75.00	C72285	C71285	C73285
9/16	U		.3160	4.500		3.188		C72085	C71085	C73084	
			8.10	.3189		117.00		75.00	C72286	C71286	-
	V		.3228		117.00		75.00	C72287	C71287	-	
			8.20	.3230	4.625		3.313		C72086	C71086	C73085
5/8	W		.3281	4.625		3.313		C72021	C71021	C73021	
			8.40	.3307		117.00		75.00	C72289	C71289	-
	X		.3320	4.750		3.438			C72087	C71087	C73086
			8.50	.3346		117.00		75.00	C72290	C71290	C73290
3/4	Y		.3390	4.750		3.438		C72088	C71088	C73087	
			8.70	.3425		125.00		81.00	C72292	C71292	-
	Z		.3438	4.750		3.438			C72022	C71022	C73022
			8.80	.3464		125.00		3.189	C72293	C71293	-
7/8	AA		.3480	4.875		3.500		C72089	C71089	C73088	
			9.00	.3543		125.00		81.00	C72295	C71295	C73295
	AB		.3580	4.875		3.500			C72090	C71090	C73089
			23/64	.3594	4.875		3.500		C72023	C71023	C73023
AC		9.20	.3622		125.00		81.00	C72297	C71297	-	
		9.30	.3661		125.00		81.00	C72298	C71298	-	
AD		.3680	5.000		3.625			C72091	C71091	C73090	

continued on next page

fraction	drill diameter		overall length		flute length		order number			
	d ₁		l ₁		l ₂		2002G	2001G	2002G-TC	
	wire/letter	mm	in	mm	in	mm	bright	black oxide	TiCN	
3/8	V	9.40	.3700		125.00	81.00	C72299	C71299	-	
		9.50	.3740		125.00	81.00	C72300	C71300	C73300	
			.3750	5.000		3.625	3.625	C72024	C71024	C73024
	W		.3770	5.000		3.625	3.625	C72092	C71092	C73091
		9.60	.3779		133.00	87.00		C72301	C71301	-
		9.70	.3817		133.00	87.00		C72302	C71302	-
25/64	X	9.80	.3858		133.00	87.00	C72303	C71303	-	
			.3860	5.125		3.750	3.750	C72093	C71093	C73092
			.3906	5.125		3.750	3.750	C72025	C71025	C73025
	Y	10.00	.3937		133.00	87.00		C72305	C71305	C73305
			.3970		130.18	95.25		C72094	C71094	C73093
		10.20	.4016		133.00	87.00		C72306	C71306	C73306
13/32	Z		.4040	5.250		3.875	C72095	C71095	C73094	
			.4062	5.250		3.875	3.875	C72026	C71026	C73026
			.4130	5.250		3.875	3.875	C72096	C71096	C73095
	7/16	10.50	.4134		133.00	87.00		C72308	C71308	C73308
			.4219	5.375		3.938	3.938	C72027	C71027	C73027
		10.80	.4252		142.00	94.00		C72309	C71309	-
7/16	Z	11.00	.4331		142.00	94.00	C72310	C71310	C73310	
			.4375	5.500		4.063	4.063	C72028	C71028	C73028
		11.20	.4409		142.00	94.00		C72311	C71311	-
	29/64		.4527		142.00	94.00		C72312	C71312	C73312
		15/32	.4531	5.625		4.188	4.188	C72029	C71029	C73029
			.4688	5.750		4.313	4.313	C72030	C71030	C73030
31/64	Z	12.00	.4724		151.00	101.00	C72314	C71314	C73314	
			.4803		151.00	101.00		C72315	C71315	-
			.4844	5.875		4.375	4.375	C72031	C71031	C73031
	1/2	12.50	.4921		151.00	101.00		C72316	C71316	C73316
			.5000	6.000		4.500	4.500	C72032	C71032	C73032
		13.00	.5118		151.00	101.00		C72319	C71319	C73319
33/64	Z		.5156	6.625		4.813	-	C71033	-	
		17/32	.5312	6.625		4.813		-	C71034	-
			.5315	160.00		108.00	108.00	C72321	C71321	-
	35/64		.5469	6.625		4.813	4.813	-	C71035	-
		9/16	.5512	160.00		108.00	108.00	C72323	C71323	C73323
			.5625	6.625		4.813	4.813	-	C71036	-
37/64	Z	14.50	.5709		169.00	114.00	C72325	C71325	-	
			.5781	6.625		4.813	4.813	-	C71037	-
		15.00	.5906		169.00	114.00		C72327	C71327	C73327
	19/32		.5938	7.125		5.188	5.188	-	C71038	-
		39/64	.6094	7.125		5.188	5.188	-	C71039	-
			.6102	178.00		120.00	120.00	C72329	C71329	-
5/8	Z	15.50	.6250	7.125		5.188	-	C71040	-	
			.6299	178.00		120.00	120.00	C72331	C71331	C73331
		41/64	.6406	7.125		5.188	5.188	-	C71041	-
	21/32		.6496	184.00		120.00	120.00	C72333	C71333	-
			.6562	7.125		5.188	5.188	-	C71042	-
		17.00	.6693		184.00	120.00		C72335	C71335	C73335
43/64	Z		.6719	7.625		5.625	-	C71043	-	
		11/16	.6875	7.625		5.625	5.625	-	C71044	-
			.6890	191.00		130.00	130.00	C72337	C71337	-

continued on next page

Material Reference	Steel (HRc)				Stainless Steel			Cast Iron (HRc)		Aluminum and Non-Ferrous	Hi-Temp Alloy		Hardened Steel (HRc)
	Low Carbon		Alloy		Austenitic	Martensitic	PH	Gray	Nodular		Ni, Co, Fe Based Super Alloy	Titanium	
	Hardness	13-38	>38	16-38	> 38	300 Series	400 series		18-22	22-32			>45
Bright										◆			
Black Oxide	◆				◆			◆					
TiCN	☆		☆		☆			☆		☆			

☆ = Best Performance ◆ = Acceptable

Jobber Length

High Speed Steel

order number

no. of pieces	size range	2002G	2002G
		bright	black oxide
15	1/16" through 1/2" x 1/3 2"	C72199	
29	1/16" through 1/2" x 1/64"	C72198	C72197
26	letter A through Z	C00939	
60	wire gauge #1 through #60	C00934	
115	1/16" through 1/2", letter A through Z, and wire gage #1 through #60	C01330	
25	1 mm through 13 mm x 0.5 mm	C72000	C71000
50	1 mm through 5.9 mm x 0.1 mm		C00960



115-Piece Set
#C01330



50-Piece Set
#C00690



60-Piece Set
#C00934



25-Piece Set
#C71000

Material Reference	Steel (HRc)				Stainless Steel			Cast Iron (HRc)		Aluminum and Non-Ferrous	Hi-Temp Alloy		Hardened Steel (HRc)
	Low Carbon		Alloy		Austenitic	Martensitic	PH	Gray	Nodular		Ni, Co, Fe Based Super Alloy	Titanium	
Hardness	13-38	>38	16-38	> 38	300 Series	400 series		18-22	22-32				>45
Bright										◆			
Black Oxide	◆				◆			◆					
TiCN	☆		☆		☆			☆		☆			

☆ = Best Performance ◆ = Acceptable

Styles: **2002, 2001**

General Purpose

Note

Operating parameters: See Technical section
All sizes feature uncleared diameter.

ASME
B94.11M

DIN
338

HSS



Surface
Treatment

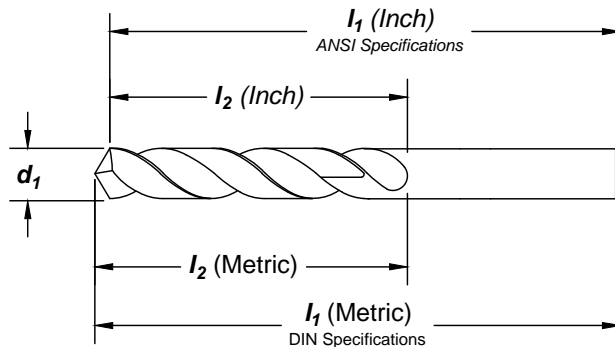

Jobber Length

High Speed Steel

Feature:

General purpose jobber drill for effective drilling in medium and softer materials.

drill diameter		overall length		flute length		order number	
fraction	d ₁ wire	decimal equivalent	I ₁ in	I ₂ in	I ₂ mm	2002 Bright	2001 black oxide
	80	.0135	.750		.125	C01799	C01012
		0.35		19.00	3.00	-	C01013
	79	.0145	.750		.188	C01801	C01014
		0.38		19.00	4.00	-	C01015
1/64		.0156	.750		.188	C01803	C01016
		0.40		20.00	5.00	-	C01017
	78	.0160	.875		.188	C01805	C01018
		0.42		20.00	5.00	-	C01019
		0.45		20.00	5.00	-	C01020
	77	.0180	.875		.188	C01808	C01021
		0.48		20.00	5.00	-	C01022
		0.50		22.00	6.00	-	C01023
	76	.0200	.875		.188	C01811	C01024
	75	.0210	1.000		.250	C01812	C01025
		0.55		24.00	7.00	-	C01026
	74	.0225	1.000		.250	C01814	C01027
		0.60		24.00	7.00	-	C01028
	73	.0240	1.125		.313	C01816	C01029
	72	.0250	1.125		.313	C01817	C01030
		0.65		26.00	8.00	-	C01031
	71	.0260	1.250		.375	C01819	C01032
		0.70		28.00	9.00	-	C01033
	70	.0280	1.250		.375	C01821	C01034
	69	.0292	1.375		.500	C01822	C01035
		0.75		28.00	9.00	-	C01036
	68	.0310	1.375		.500	C01824	C01037

continued on next page

Material Reference	Steel (HRc)				Stainless Steel			Cast Iron (HRc)		Aluminum and Non-Ferrous	Hi-Temp Alloy		Hardened Steel (HRc)
	Low Carbon		Alloy		Austenitic	Martensitic	PH	Gray	Nodular		Ni, Co, Fe Based Super Alloy	Titanium	
Hardness	13-38	>38	16-38	> 38	300 Series	400 series		18-22	22-32				>45
Bright	★		★					★		☆			
Black Oxide	☆		☆					☆					

☆ = Best Performance ★ = Acceptable

General Purpose

Styles: **2002, 2001** (continued)

Jobber Length

High Speed Steel

drill diameter			overall length		flute length		order number		
fraction	d ₁ wire	mm	decimal equivalent	l ₁ in	mm	l ₂ in	mm	2002 Bright	2001 black oxide
1/32			.0312	1.375		.500		C01825	C01038
		0.80	.0315		30.00		10.00	-	C01039
	67		.0320	1.375		.500		C01827	C01040
	66		.0330	1.375		.500		C01828	C01041
		0.85	.0335		30.00		10.00	-	C01042
	65		.03 50	1.500		.625		C01830	C01043
		0.90	.0354		32.00		11.00	-	C01044
	64		.0360	1.500		.625		C01832	C01045
	63		.0370	1.500		.625		C01833	C01046
		0.95	.0374		32.00		11.00	-	C01047
	62		.0380	1.500		.625		C01835	C01048
	61		.0390	1.500		.688		C01836	C01049
		5.30	.2087		95.00		64.00	-	C01181
		5.80	.2283		98.00		67.00	-	C01192

General Purpose

SET

Style: **2002**



no. of pieces	surface treatment	size range	order number
20	Bright	#61-#80	2002 C00937



TECH TIPS

Bright versus Surface Treated Tools

- Bright (untreated) series are used in non-ferrous materials.
- Black oxide drills provide better wear life in ferrous materials.

Material Reference	Steel (HRc)				Stainless Steel			Cast Iron (HRc)		Aluminum and Non-Ferrous	Hi-Temp Alloy		Hardened Steel (HRc)
	Low Carbon		Alloy		Austenitic	Martensitic	PH	Gray	Nodular		Ni, Co, Fe Based Super Alloy	Titanium	
Hardness	13-38	>38	16-38	> 38	300 Series	400 series		18-22	22-32				>45
Bright	◆		◆					◆		☆			
Black Oxide	☆		☆					☆					

☆ = Best Performance ◆ = Acceptable

Style: 2020

Low Helix

Note

Operating parameters: See Technical section



Surface Treatment

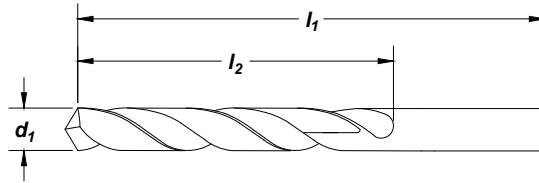

Jobber Length

High Speed Steel

Feature:

Slower helix aids chip removal in horizontal application.

drill diameter		wire	decimal equivalent	overall length		order no.
fraction	d ₁			l ₁ (in)	l ₂ (in)	
		60	.0400	1.625	.688	C03457
		59	.0410	1.625	.688	C03458
		58	.0420	1.625	.688	C03460
		57	.0430	1.750	.750	C03461
		56	.0465	1.750	.750	C03464
		55	.0520	1.875	.875	C03469
		54	.0550	1.875	.875	C03471
		53	.0595	1.875	.875	C03475
1/16			.0625	1.875	.875	C03477
		52	.0635	1.875	.875	C03479
		51	.0670	2.000	1.000	C03482
		50	.0700	2.000	1.000	C03484
		49	.0730	2.000	1.000	C03487
		48	.0760	2.000	1.000	C03489
5/64			.0781	2.000	1.000	C03491
		47	.0785	2.000	1.000	C03492
		46	.0810	2.125	1.125	C03495
		45	.0820	2.125	1.125	C03496
		44	.0860	2.125	1.125	C03499
		43	.0890	2.250	1.250	C03502
		42	.0935	2.250	1.250	C03505
3/32			.0938	2.250	1.250	C03506
		41	.0960	2.375	1.375	C03508
		40	.0980	2.375	1.375	C03510
		39	.0995	2.375	1.375	C03512
		38	.1015	2.500	1.438	C03513
		37	.1040	2.500	1.438	C03515
		36	.1065	2.500	1.438	C03517
7/64			.1094	2.625	1.500	C03519
		35	.1100	2.625	1.500	C03520
		34	.1110	2.625	1.500	C03522
		33	.1130	2.625	1.500	C03523
		32	.1160	2.750	1.625	C03525

continued on next page

Material Reference	Steel (HRC)				Stainless Steel			Cast Iron (HRC)		Aluminum and Non-Ferrous	Hi-Temp Alloy		Hardened Steel (HRC)
	Low Carbon		Alloy		Austenitic	Martensitic	PH	Gray	Nodular		Ni, Co, Fe Based Super Alloy	Titanium	
Hardness	13-38	>38	16-38	> 38	300 Series	400 series		18-22	22-32			>45	
Bright	☆									☆			

☆ = Best Performance ◆ = Acceptable

Low Helix

Style: 2020 (continued)

Jobber Length
High Speed Steel

fraction	drill diameter		decimal equivalent	overall length		flute length		order no.
	d ₁	wire		l ₁ (in)	l ₂ (in)	l ₂ (in)	2020	
1/8		31	.1200	2.750	1.625		C03527	
				.1250	2.750	1.625	C03529	
			30	.1285	2.750	1.625	C03532	
			29	.1360	2.875	1.750	C03535	
9/64		28	.1405	2.875	1.750		C03537	
				.1406	2.875	1.750		C03538
			27	.1440	3.000	1.875		C03540
			26	.1470	3.000	1.875		C03542
			25	.1495	3.000	1.875		C03544
			24	.1520	3.125	2.000		C03546
5/32		23	.1540	3.125	2.000		C03548	
				.1562	3.125	2.000		C03549
			22	.1570	3.125	2.000		C03550
			21	.1590	3.250	2.125		C03552
			20	.1610	3.250	2.125		C03553
			19	.1660	3.250	2.125		C03556
			18	.1695	3.250	2.125		C03559
11/64			.1719	3.250	2.125		C03560	
			17	.1730	3.375	2.188		C03561
			16	.1770	3.375	2.188		C03563
			15	.1800	3.375	2.188		C03565
			14	.1820	3.375	2.188		C03567
			13	.1850	3.500	2.313		C03568
3/16			.1875	3.500	2.313		C03571	
			12	.1890	3.500	2.313		C03572
			11	.1910	3.500	2.313		C03574
			10	.1935	3.625	2.438		C03576
			9	.1960	3.625	2.438		C03577
			8	.1990	3.625	2.438		C03579
			7	.2010	3.625	2.438		C03581
				.2031	3.625	2.438		C03582
13/64			.2040	3.750	2.500		C03583	
			6	.2055	3.750	2.500		C03585
			5	.2090	3.750	2.500		C03588
			4	.2130	3.750	2.500		C03590
			3	.2188	3.750	2.500		C03592
7/32			.2210	3.875	2.625		C03594	
			2	.2280	3.875	2.625		C03597
			1	.2344	3.875	2.625		C03601
15/64		.2500	4.000	2.750		C03610		
17/64		.2656	4.125	2.875		C03618		
9/32		.2812	4.250	2.938		C03632		
19/64		.2969	4.375	3.063		C03636		
5/16		.3125	4.500	3.188		C03643		
21/64		.3281	4.625	3.313		C03651		
11/32		.3438	4.750	3.438		C03658		
3/8		.3750	5.000	3.625		C03673		
25/64		.3906	5.125	3.750		C03681		
13/32		.4062	5.250	3.875		C03686		
27/64		.4219	5.375	3.938		C03689		
7/16		.4375	5.500	4.063		C03692		
29/64		.4531	5.625	4.188		C03695		
15/32		.4688	5.750	4.313		C03697		
1/2		.5000	6.000	4.500		C03702		

Material Reference	Steel (HRC)				Stainless Steel			Cast Iron (HRC)		Aluminum and Non-Ferrous	Hi-Temp Alloy		Hardened Steel (HRC)
	Low Carbon		Alloy		Austenitic	Martensitic	PH	Gray	Nodular		Ni, Co, Fe Based Super Alloy	Titanium	
	Hardness	13-38	>38	16-38	> 38	300 Series	400 series		18-22	22-32			>45
Bright	☆									☆			

☆ = Best Performance ◆ = Acceptable

Note
Operating parameters: See Technical section

ASME
B94.11M

HSS



Surface
Treatment

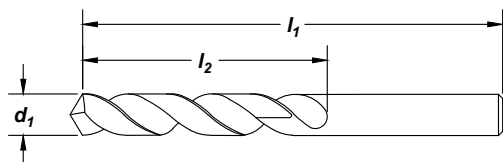

Feature:

Higher helix for improved chip lifting in softer materials.

drill diameter		decimal equiv.	overall length		flute length	order no.
d ₁ fraction	wire		l ₁ (in)	l ₂ (in)		
80	.0135	.750	.188	C02881		
79	.0145	.750	.188	C02883		
78	.0160	.875	.188	C02887		
77	.0180	.875	.188	C02890		
76	.0200	.875	.188	C02893		
75	.0210	1.000	.250	C02894		
74	.0225	1.000	.250	C02896		
73	.0240	1.125	.313	C02898		
72	.0250	1.125	.313	C02899		
71	.0260	1.250	.375	C02901		
70	.0280	1.250	.375	C02903		
69	.0292	1.375	.500	C02904		
68	.0310	1.375	.500	C02906		
1/32	.0312	1.375	.500	C02907		
67	.0320	1.375	.500	C02909		
66	.0330	1.375	.500	C02910		
65	.0350	1.500	.625	C02912		
64	.0360	1.500	.625	C02914		
63	.0370	1.500	.625	C02915		
62	.0380	1.500	.625	C02917		
61	.0390	1.625	.688	C02918		
60	.0400	1.625	.688	C02920		
59	.0410	1.625	.688	C02921		
58	.0420	1.625	.688	C02923		
57	.0430	1.750	.750	C02924		
56	.0465	1.750	.750	C02927		
3/64	.0469	1.750	.750	C02928		

drill diameter		decimal equiv.	overall length		flute length	order no.
d ₁ fraction	wire		l ₁ (in)	l ₂ (in)		
55	.0520	1.875	.875	C02932		
54	.0550	1.875	.875	C02934		
53	.0595	1.875	.875	C02938		
1/16	.0625	1.875	.875	C02940		
52	.0635	1.875	.875	C02942		
51	.0670	2.000	1.000	C02945		
50	.0700	2.000	1.000	C02947		
49	.0730	2.000	1.000	C02950		
48	.0760	2.000	1.000	C02952		
5/64	.0781	2.000	1.000	C02954		
47	.0785	2.000	1.000	C02955		
46	.0810	2.125	1.125	C02958		
45	.0820	2.125	1.125	C02959		
44	.0860	2.125	1.125	C02962		
43	.0890	2.250	1.250	C02965		
42	.0935	2.250	1.250	C02968		
3/32	.0938	2.250	1.250	C02969		
41	.0960	2.375	1.375	C02971		
40	.0980	2.375	1.375	C02973		
39	.0995	2.375	1.375	C02975		
38	.1015	2.500	1.438	C02976		
37	.1040	2.500	1.438	C02978		
36	.1065	2.500	1.438	C02980		
7/64	.1094	2.625	1.500	C02982		
35	.1100	2.625	1.500	C02983		
34	.1110	2.625	1.500	C02985		
33	.1130	2.625	1.500	C02986		

continued on next page

Material Reference	Steel (HRC)				Stainless Steel			Cast Iron (HRC)		Aluminum and Non-Ferrous	Hi-Temp Alloy		Hardened Steel (HRC)
	Low Carbon		Alloy		Austenitic	Martensitic	PH	Gray	Nodular		Ni, Co, Fe Based Super Alloy	Titanium	
	Hardness	13-38	>38	16-38	> 38	300 Series	400 series		18-22	22-32			>45
Bright	☆									☆			

☆ = Best Performance ◆ = Acceptable

High Helix

Style: 2012 (continued)

Jobber Length

High Speed Steel

drill diameter		decimal equiv.	overall length		flute length		order no.
d ₁ fraction	wire		l ₁ (in)	l ₂ (in)	2012		
	32	.1160	2.750	1.625		C02988	
	31	.1200	2.750	1.625		C02990	
1/8		.1250	2.750	1.625		C02992	
	30	.1285	2.750	1.625		C02995	
	29	.1360	2.875	1.750		C02998	
	28	.1405	2.875	1.750		C03000	
9/64		.1406	2.875	1.750		C03001	
	27	.1440	3.000	1.875		C03003	
	26	.1470	3.000	1.875		C03005	
	25	.1495	3.000	1.875		C03007	
	24	.1520	3.125	2.000		C03009	
	23	.1540	3.125	2.000		C03011	
5/32		.1562	3.125	2.000		C03012	
	22	.1570	3.125	2.000		C03013	
	21	.1590	3.250	2.125		C03015	
	20	.1610	3.250	2.125		C03016	
	19	.1660	3.250	2.125		C03019	
	18	.1695	3.250	2.125		C03022	
11/64		.1719	3.250	2.125		C03023	
	17	.1730	3.375	2.188		C03024	
	16	.1770	3.375	2.188		C03026	
	15	.1800	3.375	2.188		C03028	
	14	.1820	3.375	2.188		C03030	
	13	.1850	3.500	2.313		C03031	
3/16		.1875	3.500	2.313		C03034	
	12	.1890	3.500	2.313		C03035	
	11	.1910	3.500	2.313		C03037	
	10	.1935	3.625	2.438		C03039	
	9	.1960	3.625	2.438		C03040	
	8	.1990	3.625	2.438		C03042	
	7	.2010	3.625	2.438		C03044	
13/64		.2031	3.625	2.438		C03045	
	6	.2040	3.750	2.500		C03046	
	5	.2055	3.750	2.500		C03048	
	4	.2090	3.750	2.500		C03051	
	3	.2130	3.750	2.500		C03053	
7/32		.2188	3.750	2.500		C03055	
	2	.2210	3.875	2.625		C03057	
	1	.2280	3.875	2.625		C03060	
	A	.2340	3.875	2.625		C03063	
15/64		.2344	3.875	2.625		C03064	
	B	.2380	4.000	2.750		C03066	
	C	.2420	4.000	2.750		C03068	

drill diameter		decimal equiv.	overall length		flute length		order no.
d ₁ fraction	wire		l ₁ (in)	l ₂ (in)	2012		
	D	.2460	4.000	2.750		C03070	
1/4	E	.2500	4.000	2.750		C03073	
	F	.2570	4.125	2.875		C03077	
	G	.2610	4.125	2.875		C03079	
17/64		.2656	4.125	2.875		C03081	
	H	.2660	4.125	2.875		C03083	
	I	.2720	4.125	2.875		C03086	
	J	.2770	4.125	2.875		C03088	
	L	.2900	4.250	2.938		C03094	
9/32		.2812	4.250	2.938		C03095	
	M	.2950	4.375	3.063		C03097	
19/64		.2969	4.375	3.063		C03099	
	N	.3020	4.375	3.063		C03101	
5/16		.3125	4.500	3.188		C03106	
	O	.3160	5.750	3.188		C03108	
	P	.3230	4.625	3.313		C03111	
21/64		.3281	4.625	3.313		C03114	
	Q	.3320	4.750	3.438		C03116	
	R	.3390	4.750	3.438		C03119	
11/32		.3438	4.750	3.438		C03121	
	S	.3480	4.875	3.500		C03124	
	T	.3580	4.875	3.500		C03127	
23/64		.3594	4.875	3.500		C03129	
	U	.3680	5.000	3.625		C03133	
3/8		.3750	5.000	3.625		C03136	
	V	.3770	5.000	3.625		C03137	
	W	.3860	5.125	3.750		C03142	
25/64		.3906	5.125	3.750		C03144	
	X	.3970	5.125	3.750		C03146	
	Y	.4040	5.250	3.875		C03148	
13/32		.4062	5.250	3.875		C03149	
	Z	.4130	5.250	3.875		C03150	
27/64		.4219	5.375	3.938		C03152	
7/16		.4375	5.500	4.063		C03155	
29/64		.4531	5.625	4.188		C03158	
15/32		.4688	5.750	4.313		C03160	
31/64		.4844	5.875	4.375		C03163	
1/2		.5000	6.000	4.500		C03165	

Material Reference	Steel (HRc)				Stainless Steel			Cast Iron (HRc)		Aluminum and Non-Ferrous	Hi-Temp Alloy		Hardened Steel (HRc)
	Low Carbon		Alloy		Austenitic	Martensitic	PH	Gray	Nodular		Ni, Co, Fe Based Super Alloy	Titanium	
	Hardness	13-38	>38	16-38	> 38	300 Series	400 series		18-22	22-32			>45
Bright	☆									☆			

☆ = Best Performance ◆ = Acceptable

Styles: 2065, 2065-TN
Parabolic
Note

Operating parameters: See Technical section
Adjust the parameters as follows:
double the given feed rate.

**ASME
B94.11M**
HSS

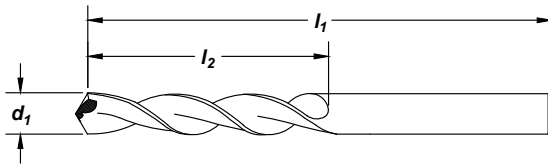
**Surface
Treatment**

Jobber Length
High Speed Steel
Feature:

Excels in deep hole drilling without pecking in softer, free machining materials. Drill up to 10x diameter without pecking.

drill diameter		wire	decimal equivalent	overall length		order number	
fraction	d ₁			l ₁ (in)	l ₂ (in)	2065 Bright	2065-TN TiN
1/16		52	.0635	1.875	.875	C16029	C03705
		51	.0670	2.000	1.000	C16219	-
		50	.0700	2.000	1.000	C16218	-
		49	.0730	2.000	1.000	-	C03708
		47	.0781	2.000	1.000	C16216	-
5/64		47	.0785	2.000	1.000	C16030	C03711
		45	.0820	2.125	1.125	C16214	-
		43	.0890	2.250	1.250	C16212	-
		42	.0935	2.250	1.250	C16210	-
		41	.0938	2.250	1.250	C16209	-
3/32		41	.0960	2.250	1.250	C16031	C03718
		40	.0980	2.375	1.375	C16208	-
		39	.0985	2.375	1.375	C16207	C03720
		38	.0995	2.375	1.375	C16206	-
		38	.1015	2.500	1.438	C16205	C03722
7/64		36	.1065	2.500	1.438	C16203	C03724
		33	.1094	2.625	1.500	C16032	C03725
		32	.1130	2.625	1.500	C16200	C03728
		32	.1160	2.750	1.625	C16199	-
		31	.1200	2.750	1.625	C16198	C03730
1/8		30	.1250	2.750	1.625	C16033	C03731
		30	.1285	2.750	1.625	C16197	C03732
		29	.1360	2.875	1.750	C16196	C03733
		28	.1405	2.875	1.750	C16195	-
		28	.1406	2.875	1.750	C16034	-
9/64		27	.1440	3.000	1.875	C16194	-
		27	.1470	3.000	1.875	C16193	-
		26	.1470	3.000	1.875	C16193	-

continued on next page

Material Reference	Steel (HRC)				Stainless Steel			Cast Iron (HRC)		Aluminum and Non-Ferrous	Hi-Temp Alloy		Hardened Steel (HRC)
	Low Carbon		Alloy		Austenitic	Martensitic	PH	Gray	Nodular		Ni, Co, Fe Based Super Alloy	Titanium	
	Hardness	13-38	>38	16-38	> 38	300 Series	400 series		18-22	22-32			>45
Bright	◆		◆		◆					☆			
TiN	☆		☆		☆								

☆ = Best Performance ◆ = Acceptable

Parabolic

Styles: 2065, 2065-TN (continued)

Jobber Length
Cobalt

fraction	drill diameter		decimal equivalent	overall length l ₁ (in)	flute length l ₂ (in)	order number	
	d ₁	wire				2065 Bright	2065-TN TiN
		25	.1495	3.000	1.875	C16192	C03738
5/32			.1562	3.125	2.000	C16035	C03741
		22	.1570	3.125	2.000	C16189	C03742
		21	.1590	3.500	2.313	C16188	C03743
		20	.1610	3.250	2.125	C16187	-
		19	.1695	3.250	2.125	C16186	C03745
11/64			.1719	3.250	2.125	C16036	C03747
		17	.1730	3.375	2.188	C16184	-
		16	.1770	3.375	2.188	C16183	-
		15	.1800	3.375	2.188	-	C03750
		14	.1820	3.375	2.188	C16181	C03751
		13	.1850	3.500	2.313	C16180	C03752
3/16			.1875	3.500	2.313	C16037	C03753
		12	.1890	3.500	2.313	C16179	-
		11	.1910	3.500	2.313	C16178	-
		10	.1935	3.625	2.438	C16177	C03756
		9	.1960	3.625	2.438	C16176	-
		8	.1990	3.625	2.438	C16175	C03758
		7	.2010	3.625	2.438	C16174	-
13/64			.2031	3.625	2.438	C16038	C03760
		6	.2040	3.750	2.500	C16173	C03761
		5	.2055	3.750	2.500	C16172	C03762
		4	.2090	3.750	2.500	C16171	-
		3	.2130	3.750	2.500	C16170	C03764
7/32			.2188	3.750	2.500	C16039	C03765
		2	.2210	3.875	2.625	C16169	-
		1	.2280	3.875	2.625	C16168	-
15/64			.2344	3.875	2.625	C16040	-
1/4	E		.2500	4.000	2.750	C16041	C03773
17/64			.2656	4.125	2.875	C16042	C03776
9/32			.2812	4.250	2.938	C16043	C03781
19/64			.2969	4.375	3.063	C16044	C03784
5/16			.3125	4.500	3.188	C16045	C03786
21/64			.3281	4.625	3.313	C16046	-
11/32			.3438	4.750	3.438	C16047	-
23/64			.3594	4.875	3.500	C16048	-
3/8			.3750	5.000	3.625	C16049	-
25/64			.3906	5.125	3.750	C16050	-
13/32			.4062	5.250	3.875	C16051	C03801
27/64			.4219	5.375	3.938	C16052	-
7/16			.4375	5.500	4.063	C16053	C03804
29/64			.4531	5.625	4.188	C16054	-
15/32			.4688	5.750	4.313	C16055	C03806
31/64			.4844	5.875	4.375	C16056	C03807
1/2			.5000	6.000	4.500	C16057	-

Material Reference	Steel (HRc)				Stainless Steel			Cast Iron (HRc)		Aluminum and Non-Ferrous	Hi-Temp Alloy		Hardened Steel (HRc)
	Low Carbon		Alloy		Austenitic	Martensitic	PH	Gray	Nodular		Ni, Co, Fe Based Super Alloy	Titanium	
	Hardness	13-38	>38	16-38	> 38	300 Series	400 series		18-22	22-32			>45
Bright	◆		◆		◆					☆			
TiN	☆		☆		☆								

☆ = Best Performance ◆ = Acceptable

Note
Operating parameters: See Technical section

ASME
B94.11M

DIN
338

M42
Cobalt

135° Split

Helix
High
35° to 45°

Straight
Shank

Surface
Treatment

Straw
Oxide

TiN

TiCN

TiAlN

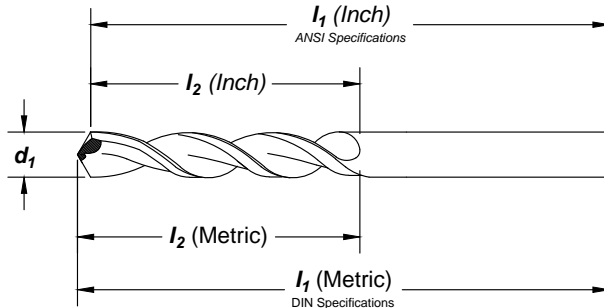

Jobber Length

Cobalt

Feature:

Effective deep hole drilling in a wide array of materials. Available coating for extended tool life and productivity. Up to 7x diameter drilling without pecking.

drill diameter		overall length		flute length		order number				
fraction	wire/let	decimal	I ₁		I ₂		2075	2075-TN	2075-TC	2075-TA
		mm	in	mm	in	mm	mm	straw oxide	TiN	TiCN
		*1.50		40.00		18.00	C16584	C16696	-	C11360
		*1.55		43.00		20.00	C15540	-	-	-
1/16		.0625	1.875		0.875		C16555	C16667	C16942	C16972
		1.60		43.00		20.00	C15541	-	-	C11361
	52	.0635	1.875		0.875		C16554	C16666	-	C11452
		1.65		43.00		20.00	C15542	-	-	-
	51	.0670	2.000		1.000		C16553	C16665	-	C11451
		1.75		46.00		22.00	C15543	-	-	-
	50	.0700	2.000		1.000		C16552	C16664	-	C11450
		1.80		46.00		22.00	C15544	-	-	-
	49	.0730	2.000		1.000		C16551	C16663	-	C11449
		1.90		46.00		22.00	C15545	-	-	-
	48	.0760	2.000		1.000		C16550	C16661	-	C11448
5/64		.0781	2.000		1.000		C16556	C16668	C16943	C16973
	47	.0785	2.000		1.000		C16549	C16660	-	C11447
		2.00		49.00		24.00	C16585	C16697	-	C11362
		2.05		49.00		24.00	C15546	-	-	-
	46	.0810	2.125		1.125		C16548	C16659	-	C11446
	45	.0820	2.125		1.125		C16547	C16658	-	C11445
		2.10		49.00		24.00	C15547	-	-	-
		2.15		53.00		27.00	C15548	-	-	-
	44	.0860	2.125		1.125		C16546	C16657	-	C11444
		2.20		53.00		27.00	C15549	-	-	-
		2.25		53.00		27.00	C15550	-	-	-
	43	.0890	2.250		1.250		C16545	C16656	C16944	C16974
		2.30		53.00		27.00	C15551	C16455	-	-
		2.35		53.00		27.00	C15552	-	-	-
	42	.0935	2.250		1.250		C16544	C16655	-	C11442
3/32		.0938	2.250	57.15	1.250	31.75	C16557	C16669	C16945	C16975
		2.40		57.00		30.00	C15553	-	-	-

*Not split point.

continued on next page

Material Reference	Steel (HRC)				Stainless Steel			Cast Iron (HRC)		Aluminum and Non-Ferrous	Hi-Temp Alloy		Hardened Steel (HRC)
	Low Carbon		Alloy		Austenitic	Martensitic	PH	Gray	Nodular		Ni, Co, Fe Based Super Alloy	Titanium	
	Hardness	13-38	>38	16-38	> 38	300 Series	400 series		18-22	22-32			>45
TiN	★		★										
TiCN	☆		☆		★	★		★	★	☆			
TiAlN					☆	☆		☆	☆				

☆ = Best Performance ★ = Acceptable



Jobber Length

Cobalt

drill diameter		overall length		flute length		order number				
d ₁		decimal equivalent	l ₁		l ₂		2075	2075-TN	2075-TC	2075-TA
fraction	wire/let		in	mm	in	mm	straw oxide	TiN	TiCN	TiAlN
	41	.0960	2.375		1.375		C16543	C16654	C16946	C16976
	40	.0980	2.375		1.375		C16542	C16652	C16947	C16977
		2.50	.0984	57.00		30.00	C16586	C16698	-	C11363
	39	.0995	2.375		1.375		C16541	C16651	C16948	C16978
	38	.1015	2.500		1.438		C16540	C16650	-	C11438
		2.60	.1024	57.00		30.00	C15554	-	-	-
	37	.1040	2.500		1.438		C16539	C16649	-	C11437
	36	.1065	2.500		1.438		C16538	C16648	C16949	C16979
7/64		.1094	2.625		1.500		C16558	C16670	C16950	C16980
	35	.1100	2.625		1.500		C16537	C16647	-	C11435
		2.80	.1102	61.00		33.00	C15555	-	-	C11364
	34	.1110	2.625		1.500		C16536	C16646	-	C11434
	33	.1130	2.625		1.500		C16535	C16645	-	C11433
		2.90	.1142	61.00		33.00	C15556	-	-	C11365
	32	.1160	2.750		1.625		C16534	C16644	-	C11432
		3.00	.1181	61.00		33.00	C16587	C16699	-	C11366
	31	.1200	2.750		1.625		C16533	C16643	-	C11431
		3.10	.1220	65.00		36.00	C15557	C16456	-	-
1/8		.1250	2.750		1.625		C16559	C16671	C16951	C16981
		3.20	.1260	65.00		36.00	C15558	C16457	-	-
	30	.1285	2.750		1.625		C16532	C16642	C16952	C16982
		3.30	.1299	65.00		36.00	C15559	-	-	C11367
		3.40	.1339	70.00		39.00	C15560	-	-	-
	29	.1360	2.875		1.750		C16531	C16641	C16953	C16983
		3.50	.1378	70.00		39.00	C16588	C16700	-	C11368
	28	.1405	2.875		1.750		C16530	C16640	-	C11428
9/64		.1406	2.875		1.750		C16560	C16672	-	C11400
	27	.1440	3.000		1.875		C16529	C16639	-	C11427
		3.70	.1457	70.00		39.00	C15561	-	-	C11369
	26	.1470	3.000		1.875		C16528	C16638	-	C11426
	25	.1495	3.000		1.875		C16527	C16637	-	C11425
	24	.1520	3.125		2.000		C16526	C16636	-	C11424
	23	.1540	3.125		2.000		C16525	C16635	-	C11423
5/32		.1562	3.125		2.000		C16561	C16673	C16954	C16984
	22	.1570	3.125		2.000		C16524	C16634	-	C11422
		4.00	.1575	75.00		43.00	C16589	C16701	-	C11370
	21	.1590	3.500		2.313		C16523	C16633	C16955	C16985
	20	.1610	3.250		2.125		C16522	C16632	-	C11420
		4.10	.1614	75.00		43.00	C15562	-	-	-
		4.20	.1654	75.00		43.00	C15563	-	-	C11371
	19	.1660	3.250		2.125		C16521	C16631	-	C11419
		4.30	.1693	80.00		47.00	C15580	-	-	-
	18	.1695	3.250		2.125		C16520	C16630	-	C11418
11/64		.1719	3.250		2.125		C16562	C16674	-	C11404
	17	.1730	3.375		2.188		C16519	C16629	-	C11417
		4.40	.1732	80.00		47.00	C15581	-	-	C11372
	16	.1770	3.375		2.188		C16518	C16628	-	C11416
		4.50	.1772	80.00		47.00	C16590	C16702	-	C11373
	15	.1800	3.375		2.188		C16517	C16626	-	C11415
	14	.1820	3.375		2.188		C16516	C16625	-	C11414
	13	.1850	3.500		2.313		C16515	C16624	-	C11413
3/16		.1875	3.500		2.313		C16563	C16675	C16956	C16986
		4.80	.1890	86.00		52.00	C15564	-	-	-
	12	.1890	3.500		2.313		C16514	C16623	-	C11412
	11	.1910	3.500		2.313		C16513	C16622	-	C11411
	10	.1935	3.625		2.438		C16512	C16621	-	C11410
	9	.1960	3.625		2.438		C16511	C16620	-	C11409
		5.00	.1969	86.00		52.00	C16591	C16703	-	C11374
	8	.1990	3.625		2.438		C16510	C16619	-	C11408
		5.10	.2008	86.00		52.00	C15565	-	-	-

continued on next page



Styles: 2075, 2075-TN, 2075-TC, 2075-TA (cont'd)

drill diameter		overall length		flute length		order number				
d ₁		decimal	l ₁		l ₂		2075	2075-TN	2075-TC	2075-TA
fraction	wire/let	equivalent	in	mm	in	mm	straw oxide	TiN	TiCN	TiAlN
13/64	7	.2010	3.625		2.438		C16509	C16618	C16957	C16987
		.2031	3.625		2.438		C16564	C16676	C16958	C16988
	6	.2040	3.750		2.500		C16508	C16617	C16959	C16989
		.2047		86.00		52.00	C16592	C16704	-	-
	5	.2055	3.750		2.500		C16507	C16616	-	C11405
	4	.2090	3.750		2.500		C16506	C16615	C16960	C16990
	3	.2130	3.750		2.500		C16505	C16614	-	C11403
7/32		.2165		93.00		57.00	C16593	C16705	-	C11375
		.2188	3.750		2.500		C16565	C16677	C16961	C16991
		.2205		93.00		57.00	C16594	C16706	-	-
	2	.2210	3.875		2.625		C16504	C16613	-	C11402
		.2244		93.00		57.00	C15566	-	-	-
	1	.2280	3.875		2.625		C16503	C16612	-	C11401
		.2283		93.00		57.00	C15582	-	-	C11376
15/64	A	.2340	3.875		2.625		C15650	-	C16430	-
		.2344	3.875		2.625		C16566	C16678	C16962	C16992
		.2362		93.00		57.00	C16595	C16707	-	C11377
	B	.2380	4.000		2.750		C15651	-	C16431	-
	C	.2420	4.000		2.750		C15652	-	C16432	-
	D	.2460	4.000		2.750		C15653	-	C16433	-
1/4	E	.2500	4.000		2.750		C16567	C16679	C16963	C16993
		.2520		101.00		63.00	C15567	-	-	-
		.2559		101.00		63.00	C16596	C16708	-	C11378
	F	.2570	4.125		2.875		C15654	-	C16434	-
		.2598		101.00		63.00	C15568	-	-	-
	G	.2610	4.125		2.875		C15655	-	C16435	-
		.2638		101.00		63.00	C15569	-	-	-
17/64		.2656	4.125		2.875		C16568	C16680	C16964	C16994
	H	.2660	4.125		2.875		C15656	-	C16436	-
		.2677		109.00		69.00	C16597	C16709	-	C11379
	I	.2720	4.125		2.875		C15657	-	C16437	-
		.2756		109.00		69.00	C16598	C16710	C16965	C16995
	J	.2770	4.125		2.875		C15658	-	C16438	-
	K	.2810	4.250		2.938		C15659	-	C16439	-
9/32		.2812	4.250		2.938		C16569	C16681	C16966	C16996
		.2835		109.00		69.00	C15570	-	-	-
	L	.2900	4.250		2.938		C15660	-	C16440	-
		.2913		109.00		69.00	C15571	-	-	-
	M	.2950	4.375	111.13	3.063	77.79	C15661	-	C16441	-
		.2953		109.00		69.00	C16599	C16711	-	C11380
19/64		.2969	4.375		3.063		C16570	C16682	-	-
	N	.3020	4.375		3.063		C15662	-	C16442	-
5/16		.3125	4.500		3.188		C16571	C16683	C16967	C16997
		.3150		117.00		75.00	C16600	C16712	-	C11381
	O	.3160	4.500		3.188		C15663	-	C16443	-
		.3189		117.00		75.00	C15572	-	-	-
		.3228		117.00		75.00	C16601	C16713	-	-
21/64	P	.3230	4.625		3.313		C15664	-	C16444	-
		.3281	4.625		3.313		C16572	C16684	-	-
	Q	.3320	4.750		3.438		C15665	-	C16445	-
		.3346		117.00		75.00	C16602	C16714	-	C11382
		.3386		125.00		81.00	C16603	C16715	-	-

continued on next page

Material Reference	Steel (HRC)				Stainless Steel			Cast Iron (HRC)		Aluminum and Non-Ferrous	Hi-Temp Alloy		Hardened Steel (HRC)
	Low Carbon		Alloy		Austenitic	Martensitic	PH	Gray	Nodular		Ni, Co, Fe Based Super Alloy	Titanium	
	13-38	>38	16-38	> 38	300 Series	400 series		18-22	22-32			>45	
TiN	★		★										
TiCN	☆		☆		★	★		★	★	☆			
TiAlN					☆	☆		☆	☆				

☆ = Best Performance ★ = Acceptable

Jobber Length

Cobalt

fraction	drill diameter		decimal equivalent	overall length		flute length		order number			
	d ₁ wire/let	mm		l ₁ in	mm	l ₂ in	mm	2075 straw oxide	2075-TN TiN	2075-TC TiCN	2075-TA TiAlN
11/32	R	8.70	.3390	4.750	3.438			C15666	-	C16446	-
			.3425	125.00	81.00			C15573	-	-	-
23/64	S	9.00	.3438	4.750	3.438			C16573	C16685	C16968	C16998
			.3480	4.875	3.500			C15667	-	C16447	-
3/8	T	9.50	.3543	125.00	81.00			C16604	C16716	-	C11383
			.3580	4.875	3.500			C15668	-	C16448	-
25/64	U	10.00	.3594	4.875	3.500			C16574	C16686	-	-
			.3680	5.000	3.625			C15669	-	C16449	-
7/16	V	10.50	.3740	125.00	81.00			C16605	C16717	-	-
			.3750	5.000	3.625			C16575	C16687	C16969	C16999
27/64	W	10.80	.3770	5.000	3.625			C15670	-	C16450	-
			.3860	5.125	3.750			C15671	-	C16451	-
13/32	X	11.00	.3906	5.125	3.750			C16576	C16688	-	-
			.3937	133.00	87.00			C16606	C16718	-	C11384
29/64	Y	11.50	.3970	5.125	3.750			C15672	-	C16452	-
			.4016	133.00	87.00			C15574	-	-	-
15/32	Z	12.00	.4040	5.250	3.875			C15673	-	C16453	-
			.4062	5.250	3.875			C16577	C16689	-	-
7/16		12.50	.4130	5.250	3.875			C15674	-	C16454	-
			.4134	133.00	87.00			C16607	C16719	-	-
31/64		12.80	.4219	5.375	3.938			C16578	C16690	-	-
			.4252	142.00	94.00			C15575	-	-	-
1/2		13.00	.4331	142.00	94.00			C16608	C16720	-	C11385
			.4375	5.500	4.063			C16579	C16691	C16970	C17000
29/64		13.50	.4409	142.00	94.00			C15576	-	-	-
			.4528	142.00	94.00			C16609	C16721	-	-
15/32		14.00	.4531	5.625	4.188			C16580	C16692	-	-
			.4688	5.750	4.313			C16581	C16693	-	-
31/64		14.50	.4724	151.00	101.00			C16610	C16722	-	C11386
			.4823	151.00	101.00			C15577	-	-	-
1/2		15.00	.4844	5.875	4.375			C16582	C16694	-	-
			.4921	151.00	101.00			C16611	C16723	-	-
1/2		15.50	.5000	6.000	4.500			C16583	C16695	C16971	C17001
			.5118	151.00	101.00			C15583	-	-	C11387

Wide Land Parabolic Q-Cobalt™

SET

Style: 2075

no. of pieces	surface treatment	size range	order number
15	straw oxide	1/16" through 1/2" x 1/32"	2075 C00901
29	straw oxide	1/16" through 1/2" x 1/64"	C00902

15-Piece Set
#C00901



29-Piece Set
#C00902



Material Reference	Steel (HRc)				Stainless Steel			Cast Iron (HRc)		Aluminum and Non-Ferrous	Hi-Temp Alloy		Hardened Steel (HRc)
	Low Carbon		Alloy		Austenitic	Martensitic	PH	Gray	Nodular		Ni, Co, Fe Based Super Alloy	Titanium	
Hardness	13-38	>38	16-38	>38	300 Series	400 series		18-22	22-32				>45
TiN	◆		◆										
TiCN	☆		☆		◆	◆		◆	◆	☆			
TiAlN					☆	☆		☆	☆				

☆ = Best Performance ◆ = Acceptable

Style: 2006
Left Hand

Note
Operating parameters: See Technical section

 ASME
B94.11M

HSS

 118°

 Helix
Regular

 Straight
Shank

 Surface
Treatment

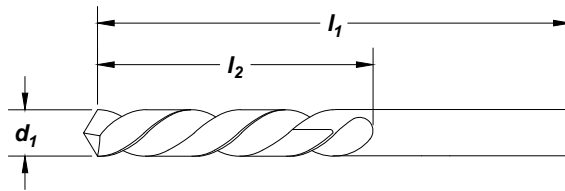
 Bright

Jobber Length

High Speed Steel

Feature:

Left Hand for reverse spindle application.

drill diameter		decimal equivalent	overall length		flute length	order no.
d_1 fraction	d_1		l_1 (in)	l_2 (in)		
1/16	.0625	1.875	.875	2006	C01401	
5/64	.0781	2.000	1.000		C01415	
3/32	.0938	2.250	1.250		C01430	
7/64	.1094	2.625	1.500		C01443	
1/8	.1250	2.750	1.625		C01453	
9/64	.1406	2.875	1.750		C01462	
5/32	.1562	3.125	2.000		C01473	
11/64	.1719	3.250	2.125		C01484	
3/16	.1875	3.500	2.313		C01495	
13/64	.2031	3.875	2.438		C01506	
7/32	.2188	3.750	2.500		C01516	
1/4	.2500	4.000	2.750		C01532	
17/64	.2656	4.125	2.875		C01538	
9/32	.2812	4.250	2.938		C01551	
5/16	.3125	4.500	3.188		C01561	
3/8	.3750	5.000	3.625		C01588	
13/32	.4062	5.250	3.875	C01600		

Material Reference	Steel (HRC)				Stainless Steel			Cast Iron (HRC)		Aluminum and Non-Ferrous	Hi-Temp Alloy		Hardened Steel (HRC)
	Low Carbon		Alloy		Austenitic	Martensitic	PH	Gray	Nodular		Ni, Co, Fe Based Super Alloy	Titanium	
	Hardness	13-38	>38	16-38	> 38	300 Series	400 series		18-22	22-32			>45
Bright	☆		☆					☆		☆			

☆ = Best Performance ◆ = Acceptable

Note
Split point for reduced thrust and easy penetration.
Operating parameters: See Technical section



Surface Treatment



Jobber Length

High Speed Steel

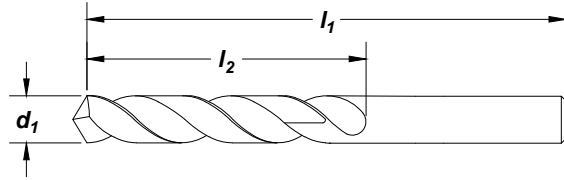

drill diameter		wire	decimal equivalent	overall length		flute length	order number
fraction	d ₁			l ₁ (in)	l ₂ (in)		2228 bright
1/16			.0625	1.875	.875	C73400	
		52	.0635	1.875	.875	C73480	
		51	.0670	2.000	1.000	C73479	
		50	.0700	2.000	1.000	C73478	
		49	.0730	2.000	1.000	C73477	
5/64		48	.0760	2.000	1.000	C73476	
			.0781	2.000	1.000	C73401	
		47	.0785	2.000	1.000	C73475	
		46	.0810	2.125	1.125	C73474	
		45	.0820	2.125	1.125	C73473	
3/32		44	.0860	2.125	1.125	C73472	
		43	.0890	2.250	1.250	C73471	
		42	.0935	2.250	1.250	C73470	
			.0938	2.250	1.250	C73402	
		41	.0960	2.375	1.375	C73469	
7/64		40	.0980	2.375	1.375	C73468	
		39	.0995	2.375	1.375	C73467	
		38	.1015	2.500	1.438	C73466	
		37	.1040	2.500	1.438	C73465	
		36	.1065	2.500	1.438	C73464	
1/8			.1094	2.625	1.500	C73403	
		35	.1100	2.625	1.500	C73463	
		34	.1110	2.625	1.500	C73462	
		33	.1130	2.625	1.500	C73461	
		32	.1160	2.750	1.625	C73460	
9/64		31	.1200	2.750	1.625	C73459	
			.1250	2.750	1.625	C73404	
		30	.1285	2.750	1.625	C73458	
		29	.1360	2.875	1.750	C73457	
		28	.1405	2.875	1.750	C73456	
5/32			.1406	2.875	1.750	C73405	
		27	.1440	3.000	1.875	C73455	
		26	.1470	3.000	1.875	C73454	
		25	.1495	3.000	1.875	C73453	
		24	.1520	3.125	2.000	C73452	
		23	.1540	3.125	2.000	C73451	
			.1562	3.125	2.000	C73406	
		22	.1570	3.125	2.000	C73450	
		21	.1590	3.250	2.125	C73449	
		20	.1610	3.250	2.125	C73448	
		19	.1660	3.250	2.125	C73447	
		18	.1695	3.250	2.125	C73446	

continued on next page

Style: 2228 (continued)

drill diameter		wire	decimal equivalent	overall length		flute length		order number
fraction	d ₁			l ₁ (in)	l ₂ (in)	2228 bright		
11/64			.1719	3.250	2.125	C73407		
		17	.1730	3.375	2.188	C73445		
		16	.1770	3.375	2.188	C73444		
		15	.1800	3.375	2.188	C73443		
		14	.1820	3.375	2.188	C73442		
		13	.1850	3.500	2.313	C73441		
3/16			.1875	3.500	2.313	C73408		
		12	.1890	3.500	2.313	C73440		
		11	.1910	3.500	2.313	C73439		
		10	.1935	3.625	2.438	C73438		
		9	.1960	3.625	2.438	C73437		
		8	.1990	3.625	2.438	C73436		
		7	.2010	3.625	2.438	C73435		
13/64			.2031	3.625	2.438	C73409		
		6	.2040	3.750	2.500	C73434		
		5	.2055	3.750	2.500	C73433		
		4	.2090	3.750	2.500	C73432		
		3	.2130	3.750	2.500	C73431		
7/32			.2188	3.750	2.500	C73410		
		2	.2210	3.875	2.625	C73430		
		1	.2280	3.875	2.625	C73429		
15/64			.2344	3.875	2.625	C73411		
1/4			.2500	4.000	2.750	C73412		
17/64			.2656	4.125	2.875	C73413		
9/32			.2812	4.250	2.938	C73414		
19/64			.2969	4.375	3.063	C73415		
5/16			.3125	4.500	3.188	C73416		
21/64			.3281	4.625	3.313	C73417		
11/32			.3438	4.750	3.438	C73418		
23/64			.3594	4.875	3.500	C73419		
3/8			.3750	5.000	3.625	C73420		
25/64			.3906	5.125	3.750	C73421		
13/32			.4062	5.250	3.875	C73422		
27/64			.4219	5.375	3.938	C73423		
7/16			.4375	5.500	4.063	C73424		
29/64			.4531	5.625	4.188	C73425		
15/32			.4688	5.750	4.313	C73426		
31/64			.4844	5.875	4.375	C73427		
1/2			.5000	6.000	4.500	C73428		

Jobber Length
High Speed Steel

Material Reference	Steel (HRC)				Stainless Steel			Cast Iron (HRC)		Aluminum and Non-Ferrous	Hi-Temp Alloy		Hardened Steel (HRC)
	Low Carbon		Alloy		Austenitic	Martensitic	PH	Gray	Nodular		Ni, Co, Fe Based Super Alloy	Titanium	
	Hardness	13-38	>38	16-38	> 38	300 Series	400 series		18-22	22-32			>45
Bright	☆		☆		◆					☆			

☆ = Best Performance ◆ = Acceptable

Note
Operating parameters: See Technical section

HSS

NAS 907
TYPE B

135° Split

Helix
Regular
21° to 34°

Straight
Shank

Surface
Treatment

Bright

Jobber Length

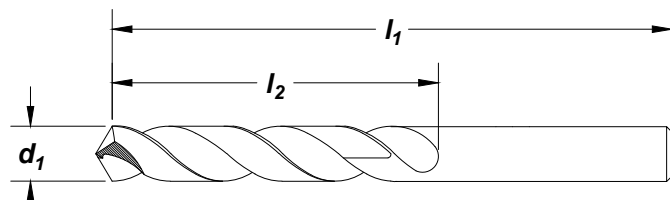

High Speed Steel

Feature:
Heavy Duty design for tougher materials.

fraction	drill diameter		decimal equivalent	overall length		flute length		order number
	d ₁ wire/letter	mm		l ₁ in	mm	l ₂ in	mm	
		* 1.00	0.0394		34.00		12.00	2222 bright
* 3/64		1.50	0.0469	1.750		0.750		C11800
			0.0591		40.00		18.00	C11600
1/16			0.0625	1.875		0.875		C11805
	#52		0.0635	1.875		0.875		C11601
	#51		0.0670	2.000		1.000		C11706
	#50		0.0700	2.000		1.000		C11705
	#49		0.0730	2.000		1.000		C11704
	#48		0.0760	2.000		1.000		C11703
5/64			0.0781	2.000		1.000		C11702
	#47		0.0785	2.000		1.000		C11602
		2.00	0.0787		49.00		24.00	C11701
	#46		0.0810	2.125		1.125		C11810
	#45		0.0820	2.125		1.125		C11700
	#44		0.0860	2.125		1.125		C11699
	#43		0.0890	2.250		1.250		C11698
	#42		0.0935	2.250		1.250		C11697
3/32			0.0938	2.250		1.250		C11696
	#41		0.0960	2.375		1.375		C11603
	#40		0.0980	2.375		1.375		C11695
		2.50	0.0984		57.00		30.00	C11694
	#39		0.0995	2.375		1.375		C11815
	#38		0.1015	2.500		1.438		C11693
	#37		0.1040	2.500		1.438		C11692
	#36		0.1065	2.500		1.438		C11691
7/64			0.1094	2.625		1.500		C11690
	#35		0.1100	2.625		1.500		C11604
	#34		0.1110	2.625		1.500		C11689
	#33		0.1130	2.625		1.500		C11688
	#32		0.1160	2.750		1.625		C11687
		3.00	0.1181		61.00		33.00	C11686
	#31		0.1200	2.750		1.625		C11820
1/8			0.1250	2.750		1.625		C11685
		3.20	0.1260		65.00		36.00	C11605
	#30		0.1285	2.750		1.625		C11822
	#29		0.1360	2.875		1.750		C11684
		3.50	0.1378		70.00		39.00	C11683
	#28		0.1405	2.875		1.750		C11825
9/64			0.1406	2.875		1.750		C11682
	#27		0.1440	3.000		1.875		C11606
	#26		0.1470	3.000		1.875		C11681
	#25		0.1495	3.000		1.875		C11680
	#24		0.1520	3.125		2.000		C11679
	#23		0.1540	3.125		2.000		C11678
5/32			0.1562	3.125		2.000		C11677
								C11607

*Not split point.

continued on next page

drill diameter		decimal		overall length		flute length		order number
fraction	d ₁ wire/letter	mm	equivalent	in	mm	in	mm	2222 bright
	#22		0.1570	3.125		2.000		C11676
		4.00	0.1575		75.00		43.00	C11830
	#21		0.1590	3.250		2.125		C11675
	#20		0.1610	3.250		2.125		C11674
		4.10	0.1614		75.00		43.00	C11831
	#19		0.1660	3.250		2.125		C11673
	#18		0.1695	3.250		2.125		C11672
11/64			0.1719	3.250		2.125		C11608
	#17		0.1730	3.375		2.188		C11671
	#16		0.1770	3.375		2.188		C11670
		4.50	0.1772		80.00		47.00	C11835
	#15		0.1800	3.375		2.188		C11669
	#14		0.1820	3.375		2.188		C11668
	#13		0.1850	3.500		2.313		C11667
3/16			0.1875	3.500		2.313		C11609
	#12		0.1890	3.500		2.313		C11666
	#11		0.1910	3.500		2.313		C11665
		4.90	0.1929		86.00		52.00	C11839
	#10		0.1935	3.625		2.438		C11664
	#9		0.1960	3.625		2.438		C11663
		5.00	0.1969		86.00		52.00	C11840
	#8		0.1990	3.625		2.438		C11662
	#7		0.2010	3.625		2.438		C11661
13/64			0.2031	3.625		2.438		C11610
	#6		0.2040	3.750		2.500		C11660
	#5		0.2055	3.750		2.500		C11659
	#4		0.2090	3.750		2.500		C11658
	#3		0.2130	3.750		2.500		C11657
		5.50	0.2165		93.00		57.00	C11845
7/32			0.2188	3.750		2.500		C11611
	#2		0.2210	3.875		2.625		C11656
	#1		0.2280	3.875		2.625		C11655
	A		0.2340	3.875		2.625		C11630
15/64			0.2344	3.875		2.625		C11612
		6.00	0.2362		93.00		57.00	C11850
	B		0.2380	4.000		2.750		C11631
	C		0.2420	4.000		2.750		C11632
	D		0.2460	4.000		2.750		C11633
1/4			0.2500	4.000		2.750		C11613
		6.50	0.2559		101.00		63.00	C11855
	F		0.2570	4.125		2.875		C11634
	G		0.2610	4.125		2.875		C11635
17/64			0.2656	4.125		2.875		C11614
	H		0.2660	4.125		2.875		C11636
	I		0.2720	4.125		2.875		C11637
		7.00	0.2756		109.00		69.00	C11860
	J		0.2770	4.125		2.875		C11638
	K		0.2810	4.250		2.938		C11639
9/32			0.2812	4.250		2.938		C11615
	L		0.2900	4.250		2.938		C11640
	M		0.2950	4.375		3.063		C11641

continued on next page
Jobber Length
High Speed Steel

Material Reference	Steel (HRc)				Stainless Steel			Cast Iron (HRc)		Aluminum and Non-Ferrous	Hi-Temp Alloy		Hardened Steel (HRc)
	Low Carbon		Alloy		Austenitic	Martensitic	PH	Gray	Nodular		Ni, Co, Fe Based Super Alloy	Titanium	
	Hardness	13-38	>38	16-38	> 38	300 Series	400 series		18-22	22-32			>45
Bright	☆		☆		◆			◆	◆	☆			

☆ = Best Performance ◆ = Acceptable

Jobber Length

High Speed Steel

fraction	drill diameter		decimal equivalent	overall length		flute length		order number
	d ₁ wire/letter	mm		l ₁ in	mm	l ₂ in	mm	
		7.50	0.2953		109.00		69.00	2222 bright
19/64			0.2969	4.375		3.063		C11865
	N		0.3020	4.375		3.063		C11616
5/16			0.3125	4.500		3.188		C11642
		8.00	0.3150		117.00		75.00	C11617
	O		0.3160	4.500		3.188		C11870
	P		0.3230	4.625		3.313		C11643
21/64			0.3281	4.625		3.313		C11644
	Q		0.3320	4.750		3.438		C11618
		8.50	0.3346		117.00		75.00	C11645
	R		0.3390	4.750		3.438		C11875
11/32			0.3438	4.750		3.438		C11646
	S		0.3480	4.875		3.500		C11619
		9.00	0.3543		125.00		81.00	C11647
	T		0.3580	4.875		3.500		C11880
23/64			0.3594	4.875		3.500		C11648
	U		0.3680	5.000		3.625		C11620
		9.50	0.3740		125.00		81.00	C11649
3/8			0.3750	5.000		3.625		C11885
	V		0.3770	5.000		3.625		C11621
	W		0.3860	5.125		3.750		C11650
25/64			0.3906	5.125		3.750		C11651
		10.00	0.3937		133.00		87.00	C11622
	X		0.3970	5.125		3.750		C11890
	Y		0.4040	5.250		3.875		C11652
13/32			0.4062	5.250		3.875		C11653
	Z		0.4130	5.250		3.875		C11623
		10.50	0.4134		133.00		87.00	C11654
27/64			0.4219	5.375		3.938		C11895
		11.00	0.4331		142.00		94.00	C11624
7/16			0.4375	5.500		4.063		C11900
		11.50	0.4528		142.00		94.00	C11625
29/64			0.4531	5.625		4.188		C11905
15/32			0.4688	5.750		4.313		C11626
		12.00	0.4724		151.00		101.00	C11627
31/64			0.4844	5.875		4.375		C11910
		12.50	0.4921		151.00		101.00	C11628
1/2			0.5000	6.000		4.500		C11915
		13.00	0.5118		151.00		101.00	C11629
								C11920

Aircraft NAS 907, Type B
Heavy Duty

SET

Style: 2222

no. of pieces	drill style	surface treatment	size range	order number
29	2222	bright	1/16" through 1/2" x 1/64"	2222 C70371



Material Reference	Steel (HRc)				Stainless Steel			Cast Iron (HRc)		Aluminum and Non-Ferrous	Hi-Temp Alloy		Hardened Steel (HRc)
	Low Carbon		Alloy		Austenitic	Martensitic	PH	Gray	Nodular		Ni, Co, Fe Based Super Alloy	Titanium	
Hardness	13-38	>38	16-38	> 38	300 Series	400 series		18-22	22-32				>45
Bright	☆		☆		◆			◆	◆	☆			

☆ = Best Performance ◆ = Acceptable

Style: Style: **2213**

Note
Operating parameters:
See Technical section

M42
Cobalt

NAS 907
TYPE J

135° Split

Helix
Regular
21° to 34°

Straight
Shank

Surface
Treatment

Straw
Oxide

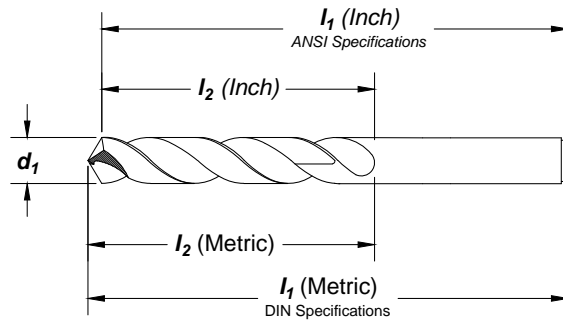

Jobber Length

Cobalt

Feature:

Highly heat resistant cobalt substrate for tough to machine materials.

drill diameter		decimal		overall length		flute length		order number
fraction	wire/letter	mm	equivalent	in	mm	in	mm	2213
	*80		.0135	.750		.125		C70213
	*79		.0145	.750		.125		C70212
*1/64			.0156	.750		.188		C70000
	*78		.0160	.875		.188		C70211
	*77		.0180	.875		.188		C70210
	*76		.0200	.875		.188		C70209
	*75		.0210	1.000		.250		C70208
	*74		.0225	1.000		.250		C70207
	*73		.0240	1.125		.313		C70206
	*72		.0250	1.125		.313		C70205
	*71		.0260	1.250		.375		C70204
	*70		.0280	1.250		.375		C70203
	*69		.0292	1.375		.500		C70202
	*68		.0310	1.375		.500		C70201
*1/32			.0312	1.375		.500		C70001
	*67		.0320	1.375		.500		C70200
	*66		.0330	1.375		.500		C70199
	*65		.0350	1.500		.625		C70198
	*64		.0360	1.500		.625		C70197
	*63		.0370	1.500		.625		C70196
	*62		.0380	1.500		.625		C70195
	*61		.0390	1.625		.688		C70194
		*1.0	.0394		34.00		12.00	C70057
	*60		.0400	1.625		.688		C70193
	*59		.0410	1.625		.688		C70192
	*58		.0420	1.625		.688		C70191
	*57		.0430	1.750		.750		C70190
		*1.1	.0433		36.00		14.00	C70058
	*56		.0465	1.750		.750		C70189
*3/64			.0469	1.750		.750		C70002

*Not split point.

continued on next page

Material Reference	Steel (HRC)		Stainless Steel			Cast Iron (HRC)		Aluminum and Non-Ferrous	Hi-Temp Alloy		Hardened Steel (HRC)
	Low Carbon	Alloy	Austenitic	Martensitic	PH	Gray	Nodular		Ni, Co, Fe Based Super Alloy	Titanium	
	Hardness	13-38	>38	16-38	> 38	300 Series	400 series		18-22	22-32	
Straw	☆		☆	☆	◆			◆	◆		

☆ = Best Performance ◆ = Acceptable

Jobber Length

Cobalt

drill diameter			overall length		flute length		order number	
fraction	d ₁ wire/letter	mm	decimal equivalent	in	l ₁ mm	l ₂ in	mm	
		*1.2	.0472		38.00		16.00	C70059
		*1.3	.0512		38.00		16.00	C70060
	*55		.0520	1.875		.875		C70188
	*54		.0550	1.875		.875		C70187
		*1.4	.0551		40.00		18.00	C70061
		*1.5	.0591		40.00		18.00	C70062
	*53		.0595	1.875		.875		C70186
1/16			.0625	1.875		.875		C70003
		1.6	.0630		43.00		20.00	C70063
	52		.0635	1.875		.875		C70185
		1.7	.0669		43.00		20.00	C70064
	51		.0670	2.000		1.000		C70184
	50		.0700	2.000		1.000		C70183
		1.8	.0709		46.00		22.00	C70065
	49		.0730	2.000		1.000		C70182
		1.9	.0748		46.00		22.00	C70220
	48		.0760	2.000		1.000		C70181
5/64			.0781	2.000		1.000		C70004
	47		.0785	2.000		1.000		C70180
		2.0	.0787		49.00		24.00	C70067
	46		.0810	2.125		1.125		C70179
	45		.0820	2.125		1.125		C70178
		2.1	.0827		49.00		24.00	C70068
	44		.0860	2.125		1.125		C70177
		2.2	.0866		53.00		27.00	C70221
	43		.0890	2.250		1.250		C70176
		2.3	.0906		53.00		27.00	C70070
	42		.0935	2.250		1.250		C70175
3/32			.0938	2.250		1.250		C70005
		2.4	.0945		57.00		30.00	C70071
	41		.0960	2.375		1.375		C70174
	40		.0980	2.375		1.375		C70173
		2.5	.0984		57.00		30.00	C70072
	39		.0995	2.375		1.375		C70172
	38		.1015	2.500		1.438		C70171
		2.6	.1024		57.00		30.00	C70073
	37		.1040	2.500		1.438		C70170
		2.7	.1063		61.00		33.00	C70074
	36		.1065	2.500		1.438		C70169
7/64			.1094	2.625		1.500		C70006
	35		.1100	2.625		1.500		C70168
		2.8	.1102		61.00		33.00	C70222
	34		.1110	2.625		1.500		C70167
	33		.1130	2.625		1.500		C70166
		2.9	.1142		61.00		33.00	C70076
	32		.1160	2.750		1.625		C70165
		3.0	.1181		61.00		33.00	C70077
	31		.1200	2.750		1.625		C70164
		3.1	.1220		65.00		36.00	C70078
1/8	1/8		.1250	2.750		1.625		C70007
		3.2	.1260		65.00		36.00	C70079
	30		.1285	2.750		1.625		C70163
		3.3	.1299		65.00		36.00	C70080
		3.4	.1339		70.00		39.00	C70081
	29		.1360	2.875		1.750		C70162
		3.5	.1378		70.00		39.00	C70082

continued on next page

Style: 2213 (continued)

drill diameter			overall length			flute length		order number
fraction	wire/letter	mm	decimal equivalent	in	mm	in	mm	
	28		.1405	2.875		1.750		C70161
9/64			.1406	2.875		1.750		C70008
		3.6	.1417		70.00		39.00	C70083
	27		.1440	3.000		1.875		C70160
		3.7	.1457		70.00		39.00	C70223
	26		.1470	3.000		1.875		C70159
	25		.1495	3.000		1.875		C70158
		3.8	.1496		75.00		43.00	C70085
	24		.1520	3.125		2.000		C70157
		3.9	.1535		75.00		43.00	C70086
	23		.1540	3.125		2.000		C70156
5/32			.1562	3.125		2.000		C70009
	22		.1570	3.125		2.000		C70155
		4.0	.1575		75.00		43.00	C70087
	21		.1590	3.250		2.125		C70154
	20		.1610	3.250		2.125		C70153
		4.1	.1614		75.00		43.00	C70088
		4.2	.1654		75.00		43.00	C70089
	19		.1660	3.250		2.125		C70152
		4.3	.1693		80.00		47.00	C70090
	18		.1695	3.250		2.125		C70151
11/64			.1719		82.55		53.98	C70010
	17		.1730	3.375		2.188		C70150
		4.4	.1732		80.00		47.00	C70091
	16		.1770	3.375		2.188		C70149
		4.5	.1772		80.00		47.00	C70092
	15		.1800	3.375		2.188		C70148
		4.6	.1811		80.00		47.00	C70224
	14		.1820	3.375		2.188		C70147
	13		.1850	3.500		2.313		C70146
		4.7	.1850		80.00		47.00	C70094
3/16			.1875	3.500		2.313		C70011
	12		.1890	3.500		2.313		C70145
		4.8	.1890		86.00		52.00	C70095
	11		.1910	3.500		2.313		C70144
		4.9	.1929		86.00		52.00	C70096
	10		.1935	3.625		2.438		C70143
	9		.1960	3.625		2.438		C70142
		5.0	.1968		86.00		52.00	C70097
	8		.1990	3.625		2.438		C70141
		5.1	.2008		86.00		52.00	C70098
	7		.2010	3.625		2.438		C70140
13/64			.2031	3.625		2.438		C70012
	6		.2040	3.750		2.500		C70139
		5.2	.2047		86.00		52.00	C70099
	5		.2055	3.750		2.500		C70138
		5.3	.2087		86.00		52.00	C70100
	4		.2090	3.750		2.500		C70137

continued on next page

Material Reference	Steel (HRC)				Stainless Steel			Cast Iron (HRC)		Aluminum and Non-Ferrous	Hi-Temp Alloy		Hardened Steel (HRC)
	Low Carbon		Alloy		Austenitic	Martensitic	PH	Gray	Nodular		Ni, Co, Fe Based Super Alloy	Titanium	
	Hardness	13-38	>38	16-38	> 38	300 Series	400 series		18-22	22-32			>45
Straw	☆		☆		☆	☆	◆	◆	◆	☆	◆	◆	

☆ = Best Performance ◆ = Acceptable



Jobber Length

Cobalt

drill diameter		decimal		overall length		flute length		order number
fraction	wire/letter	mm	equivalent	in	mm	in	mm	2213
		5.4	.2126		93.00		57.00	C70101
	3		.2130	3.750		2.500		C70136
		5.5	.2165		93.00		57.00	C70102
7/32			.2188	3.750		2.500		C70013
		5.6	.2205		93.00		57.00	C70225
	2		.2210	3.875		2.625		C70135
		5.7	.2244		93.00		57.00	C70104
	1		.2280	3.875		2.625		C70134
		5.8	.2283		93.00		57.00	C70226
	A		.2340	3.875		2.625		C70032
15/64			.2344	3.875		2.625		C70014
		6.0	.2362		93.00		57.00	C70106
	B		.2380	4.000		2.750		C70033
		6.1	.2402		101.00		63.00	C70107
	C		.2420	4.000		2.750		C70034
		6.2	.2441		101.00		63.00	C70108
	D		.2460	4.000		2.750		C70035
		6.3	.2480		101.00		63.00	C70109
1/4	E		.2500	4.000		2.750		C70015
			.2500	4.000		2.750		C70015
		6.4	.2520		101.00		63.00	C70110
		6.5	.2559		101.00		63.00	C70111
	F		.2570	4.125		2.875		C70036
		6.6	.2598		101.00		63.00	C70112
	G		.2610	4.125		2.875		C70037
		6.7	.2638		101.00		63.00	C70113
17/64			.2656	4.125		2.875		C70016
	H		.2660	4.125		2.875		C70038
		6.8	.2677		109.00		69.00	C70114
	I		.2720	4.125		2.875		C70039
		7.0	.2756		109.00		69.00	C70115
	J		.2770	4.125		2.875		C70040
9/32			.2812	4.250		2.938		C70017
	K		.2812	4.250		2.938		C70041
		7.2	.2835		109.00		69.00	C70116
	L		.2900	4.250		2.938		C70042
	M		.2950	4.375		3.063		C70043
		7.5	.2953		109.00		69.00	C70117
19/64			.2969	4.375		3.063		C70018
	N		.3020	4.375		3.063		C70044
		7.8	.3071		117.00		75.00	C70118
5/16			.3125	4.500		3.188		C70019
		8.0	.3150		117.00		75.00	C70119
	O		.3160	4.500		3.188		C70045
		8.1	.3189		117.00		75.00	C70120
	P		.3230	4.625		3.313		C70046
21/64			.3281	4.625		3.313		C70020
	Q		.3320	4.750		3.438		C70047
		8.5	.3346		117.00		75.00	C70122
	R		.3390	4.750		3.438		C70048
11/32			.3438	4.750		3.438		C70021
	S		.3480	4.875		3.500		C70049
		9.0	.3543		125.00		81.00	C70124
	T		.3580	4.875		3.500		C70050
23/64			.3594	4.875		3.500		C70022
	U		.3680	5.000		3.625		C70051

continued on next page



Style: 2213 (continued)

drill diameter			overall length		flute length		order number
fraction	wire/letter	mm	decimal equivalent	in	mm	in	
		9.5	.3740		125.00		2213 C70125
3/8			.3750	5.000		3.625	C70023
	V		.3770	5.000		3.625	C70052
	W		.3860	5.125		3.750	C70053
25/64			.3906	5.125		3.750	C70024
		10.0	.3937		133.00		87.00 C70126
	X		.3970	5.125		3.720	C70054
		10.2	.4016		133.00		87.00 C70127
	Y		.4040	5.250		3.875	C70055
13/32			.4062	5.250		3.875	C70025
	Z		.4130	5.250		3.875	C70056
		10.5	.4134		133.00		87.00 C70128
27/64			.4219	5.375		3.938	C70026
		11.0	.4331		142.00		94.00 C70129
7/16			.4375	5.500		4.063	C70027
		11.5	.4528		142.00		94.00 C70130
29/64			.4531	5.625		4.188	C70028
15/32			.4688	5.750		4.313	C70029
		12.0	.4724		151.00		101.00 C70131
31/64			.4844	5.875		4.375	C70030
		12.5	.4921		151.00		101.00 C70132
1/2			.5000	6.000		4.500	C70031
		13.0	.5118		151.00		101.00 C70133

Jobber Length
Cobalt
SET
Style: 2213
Aircraft NAS 907, Type J
Cobalt Heavy Duty

 26-Piece Set
 #C00986

no. of pieces	surface treatment	size range	order number
29	straw oxide	1/16" through 1/2" x 1/64"	C70365
26	straw oxide	A through Z letter	C00986
60	straw oxide	#1 through #60 wire gauge	C70366
115	straw oxide	1/16" through 1/2" x 1/64", A through Z and #1 through #60	C70367

 115-Piece Set
 #C70367

Material Reference	Steel (HRc)				Stainless Steel			Cast Iron (HRc)		Aluminum and Non-Ferrous	Hi-Temp Alloy		Hardened Steel (HRc)
	Low Carbon		Alloy		Austenitic	Martensitic	PH	Gray	Nodular		Ni, Co, Fe Based Super Alloy	Titanium	
	Hardness	13-38	>38	16-38	> 38	300 Series	400 series		18-22	22-32			>45
Straw	☆		☆		☆	☆	◆	◆	◆	☆	◆	◆	

☆ = Best Performance ◆ = Acceptable

Cotter Pin Heavy Duty

Style: 2011

Note
Operating parameters:
See Technical section

ASME
B94.11M

HSS

135° Split

Helix
Regular
21° to 34°

Straight
Shank

Surface
Treatment

Black
Oxide

Jobber Length

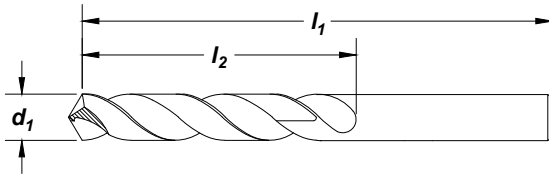

Feature:

Fast penetrating split point design. Constant parallel web for easy regrinds.

High Speed Steel

fraction	drill diameter		decimal equivalent	overall length		flute length		order number
	d ₁	wire/letter		l ₁ (in)	l ₂ (in)	l ₁ (in)	l ₂ (in)	
		*80	.0135	.750	.125			C02593
		*54	.0550	1.875	.875			C02646
1/16			.0625	1.875	.875			C02652
		52	.0635	1.875	1.000			C02654
		50	.0700	2.000	1.000			C02659
5/64			.0781	2.000	1.000			C02666
		47	.0785	2.000	1.000			C02667
		45	.0820	2.125	1.125			C02671
3/32			.0938	2.250	1.250			C02681
		40	.0980	2.375	1.375			C02685
		37	.1040	2.500	1.438			C02690
7/64			.1094	2.625	1.500			C02694
		32	.1160	2.750	1.625			C02700
		31	.1200	2.750	1.625			C02702
1/8			.1250	2.750	1.625			C02704
		30	.1285	2.750	1.625			C02707
		29	.1360	2.875	1.750			C02710
9/64			.1406	2.875	1.750			C02713
		25	.1495	3.000	1.875			C02719
5/32			.1562	3.125	2.000			C02724
11/64			.1719	3.125	2.000			C02735
3/16			.1875	3.500	2.313			C02746
7/32			.2188	3.750	2.500			C02767
15/64			.2344	3.875	2.625			C02776
1/4		E	.2500	4.000	2.750			C02785
9/32			.2812	4.250	2.938			C02807
19/64			.2969	4.375	3.063			C02811
5/16			.3125	4.500	3.188			C02818
11/32			.3438	4.750	3.188			C02833
3/8			.3750	5.000	3.625			C02848
13/32			.4062	5.250	3.875			C02861
7/16			.4375	5.500	4.063			C02867
15/32			.4688	5.750	4.313			C02872
1/2			.5000	6.000	4.500			C02877

*Not split point.

Material Reference	Steel (HRc)				Stainless Steel			Cast Iron (HRc)		Aluminum and Non-Ferrous	Hi-Temp Alloy		Hardened Steel (HRc)
	Low Carbon		Alloy		Austenitic	Martensitic	PH	Gray	Nodular		Ni, Co, Fe Based Super Alloy	Titanium	
Hardness	13-38	>38	16-38	> 38	300 Series	400 series		18-22	22-32				>45
Black Oxide	◆		☆		◆			☆	◆				

☆ = Best Performance ◆ = Acceptable

Styles: **3780, 3780-TC**

Note
High helix for efficient chip removal.
Operating parameters: See Technical section

ASME
B94.11M

M42
Cobalt

135° Split

High Helix
35° to 45°

Straight
Shank

Surface
Treatment

Black
Oxide

TiCN

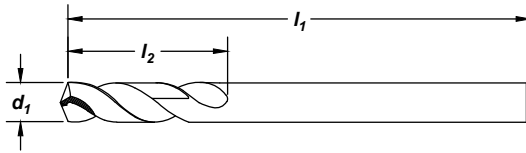

Jobber Length

Cobalt

Feature:

Preferred point for work hardening materials, with extra heavy web for superior rigidity.

drill diameter		decimal equivalent	overall length l ₁ (in)	flute length l ₂ (in)	order number	
fraction	wire/letter				3780 black oxide	3780-TC TiCN
	*60	.0400	1.625	.500	C15880	C19880
	*59	.0410	1.625	.500	C15881	-
	*58	.0420	1.625	.500	C15882	C19882
	*57	.0430	1.750	.500	C15883	-
	*56	.0465	1.750	.500	C15884	-
3/64		.0469	1.750	.500	C15885	C19885
	*55	.0520	1.750	.625	C15886	-
	*54	.0550	1.875	.625	C15887	-
	*53	.0595	1.875	.625	C15888	-
1/16		.0625	1.875	.625	C15889	C19889
	52	.0635	1.875	.688	C15890	C19890
	51	.0670	2.000	.688	C15891	-
	50	.0700	2.000	.688	C15892	C19892
	49	.0730	2.000	.688	C15893	-
	48	.0760	2.000	.688	C15894	-
5/64		.0781	2.000	.688	C15895	C19895
	47	.0785	2.000	.688	C15896	C19896
	46	.0810	2.125	.750	C15897	-
	45	.0820	2.125	.750	C15898	-
	44	.0860	2.125	.750	C15899	-
	43	.0890	2.250	.750	C15900	C19900
	42	.0935	2.250	.750	C15901	C19901
3/32		.0938	2.250	.750	C15902	C19902
	41	.0960	2.375	.813	C15903	C19903
	40	.0980	2.375	.813	C15904	C19904
	39	.0995	2.375	.813	C15905	-
	38	.1015	2.500	.813	C15906	-
	37	.1040	2.500	.813	C15907	-
	36	.1065	2.500	.813	C15908	-
7/64		.1094	2.625	.813	C15909	C19909
	35	.1100	2.625	.875	C15910	-
	34	.1110	2.625	.875	C15911	-
	33	.1130	2.625	.875	C15912	-
	32	.1160	2.750	.875	C15913	-
	31	.1200	2.750	.875	C15914	-

*Not split point.

continued on next page

Material Reference	Steel (HRC)				Stainless Steel			Cast Iron (HRC)		Aluminum and Non-Ferrous	Hi-Temp Alloy		Hardened Steel (HRC)
	Low Carbon		Alloy		Austenitic	Martensitic	PH	Gray	Nodular		Ni, Co, Fe Based Super Alloy	Titanium	
	Hardness	13-38	>38	16-38	> 38	300 Series	400 series		18-22	22-32			>45
Black Oxide	◆		◆		◆	◆		◆	◆		◆		
TiCN	☆		☆		☆	☆					☆		

☆ = Best Performance ◆ = Acceptable

Jobber Length

Cobalt

drill diameter		decimal equivalent	overall length	flute length	order number	
fraction	d ₁ wire/letter				3780 black oxide	3780-TC TiCN
1/8		.1250	2.750	.875	C15915	C19915
	30	.1285	2.750	.938	C15916	C19916
	29	.1360	2.875	.938	C15917	C19917
	28	.1405	2.875	.938	C15918	-
9/64		.1406	2.875	.938	C15919	C19919
	27	.1440	3.000	1.000	C15920	C19920
	26	.1470	3.000	1.000	C15921	C19921
	25	.1495	3.000	1.000	C15922	C19922
	24	.1520	3.125	1.000	C15923	-
	23	.1540	3.125	1.000	C15924	-
5/32		.1562	3.125	1.000	C15925	C19925
	22	.1570	3.125	1.063	C15926	-
	21	.1590	3.250	1.063	C15927	C19927
	20	.1610	3.250	1.063	C15928	C19928
	19	.1660	3.250	1.063	C15929	C19929
	18	.1695	3.250	1.063	C15930	C19930
11/64		.1719	3.250	1.063	C15931	C19931
	17	.1730	3.375	1.125	C15932	-
	16	.1770	3.375	1.125	C15933	C19933
	15	.1800	3.375	1.125	C15934	-
	14	.1820	3.375	1.125	C15935	-
	13	.1850	3.500	1.125	C15936	-
3/16		.1875	3.500	1.125	C15937	C19937
	12	.1890	3.500	1.188	C15938	-
	11	.1910	3.500	1.188	C15939	C19939
	10	.1935	3.625	1.188	C15940	C19940
	9	.1960	3.625	1.188	C15941	-
	8	.1990	3.625	1.188	C15942	C19942
	7	.2010	3.625	1.188	C15943	-
13/64		.2031	3.625	1.188	C15944	C19944
	6	.2040	3.750	1.250	C15945	-
	5	.2055	3.750	1.250	C15946	-
	4	.2090	3.750	1.250	C15947	-
	3	.2130	3.750	1.250	C15948	-
7/32		.2188	3.750	1.250	C15949	C19949
	2	.2210	3.875	1.313	C15950	-
	1	.2280	3.875	1.313	C15951	C19951
	A	.2340	3.875	1.313	C15952	-
15/64		.2344	3.875	1.313	C15953	C19953
	B	.2380	4.000	1.375	C15954	-
	C	.2420	4.000	1.375	C15955	C19955
	D	.2460	4.000	1.375	C15956	C19956
1/4		.2500	4.000	1.375	C15957	C19957
	E	.2570	4.125	1.438	C15958	C19958
	F	.2610	4.125	1.438	C15959	C19959
17/64		.2656	4.125	1.438	C15960	C19960
	H	.2660	4.125	1.500	C15961	-
	I	.2720	4.125	1.500	C15962	C19962
	J	.2770	4.125	1.500	C15963	-
	K	.2810	4.250	1.500	C15964	-
9/32		.2812	4.250	1.500	C15965	C19965
	L	.2900	4.250	1.563	C15966	-
	M	.2950	4.375	1.563	C15967	-
19/64		.2969	4.375	1.563	C15968	C19968
	N	.3020	4.375	1.625	C15969	C19969
5/16		.3125	4.500	1.625	C15970	C19970
	O	.3160	4.500	1.688	C15971	C19971

continued on next page

Styles: 3780, 3780-TC (continued)

drill diameter		decimal equivalent	overall length l ₁ (in)	flute length l ₂ (in)	order number	
fraction	d ₁ wire/letter				3780 black oxide	3780-TC TiCN
21/64	P	.3230	4.625	1.688	C15972	-
		.3281	4.625	1.688	C15973	-
	Q	.3320	4.750	1.688	C15974	C19974
	R	.3390	4.750	1.688	C15975	-
11/32		.3438	4.750	1.688	C15976	C19976
	S	.3480	4.875	1.750	C15977	-
	T	.3580	4.875	1.750	C15978	-
23/64		.3594	4.875	1.750	C15979	-
	U	.3680	5.000	1.813	C15980	-
3/8		.3750	5.000	1.813	C15981	C19981
	V	.3770	5.000	1.875	C15982	-
	W	.3860	5.125	1.875	C15983	-
25/64		.3906	5.125	1.875	C15984	-
	X	.3970	5.125	1.938	C15985	-
	Y	.4040	5.250	1.938	C15986	-
13/32		.4062	5.250	1.938	C15987	C19987
	Z	.4130	5.250	2.000	C15988	-
27/64		.4219	5.375	2.000	C15989	-
7/16		.4375	5.500	2.063	C15990	-
29/64		.4531	5.625	2.125	C15991	-
15/32		.4688	5.750	2.125	C15992	-
31/64		.4844	5.875	2.188	C15993	-
1/2		.5000	6.000	2.250	C15994	C19994

Jobber Length
Cobalt
SET
Style: 3780
Q-AMD™ Short Flute
Aircraft Maintenance

no. of pieces	surface treatment	size range	order number
29	black oxide	1/16" through 1/2" x 1/64"	3780 C14499

Material Reference	Steel (HRC)				Stainless Steel			Cast Iron (HRC)		Aluminum and Non-Ferrous	Hi-Temp Alloy		Hardened Steel (HRC)
	Low Carbon		Alloy		Austenitic	Martensitic	PH	Gray	Nodular		Ni, Co, Fe Based Super Alloy	Titanium	
Hardness	13-38	>38	16-38	> 38	300 Series	400 series		18-22	22-32				>45
Black Oxide	◆		◆		◆	◆		◆	◆		◆		
TiCN	☆		☆		☆	☆					☆		

☆ = Best Performance ◆ = Acceptable

Carbide Tipped

Style: **2727**

Note

Operating parameters:
See Technical section

HSS
Carbide
Tipped

118°

Helix
Regular
21° to 34°

Straight
Shank

Surface
Treatment

Bright

Jobber Length

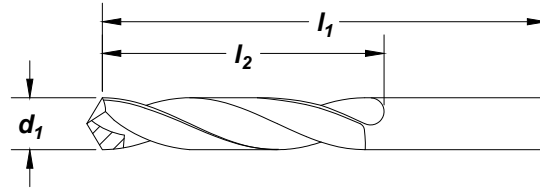

Carbide

Feature:

Run at carbide speeds with the flexibility of a HSS body and shank.

drill diameter		decimal equivalent	overall length l_1 (in)	flute length l_2 (in)	order number 2727
fraction	d_1 wire/letter				
1/8		.1250	2.750	1.625	C48655
5/32		.1562	3.125	2.000	C48675
3/16		.1875	3.500	2.313	C48697
	7	.2010	3.625	2.438	C48707
7/32		.2188	3.750	2.500	C48718
1/4	E	.2500	4.000	2.750	C48736
9/32		.2812	4.250	2.938	C48758
5/16		.3125	4.500	3.188	C48769
11/32		.3438	4.750	3.438	C48784
3/8		.3750	5.000	3.625	C48799
13/32		.4062	5.250	3.875	C48812
7/16		.4375	5.500	4.063	C48818
15/32		.4688	5.750	4.313	C48823
1/2		.5000	6.000	4.500	C48828

Material Reference	Steel (HRC)				Stainless Steel			Cast Iron (HRC)		Aluminum and Non-Ferrous	Hi-Temp Alloy		Hardened Steel (HRC)
	Low Carbon		Alloy		Austenitic	Martensitic	PH	Gray	Nodular		Ni, Co, Fe Based Super Alloy	Titanium	
Hardness	13-38	>38	16-38	> 38	300 Series	400 series		18-22	22-32				>45
Bright	☆		◆		◆			☆		☆			

☆ = Best Performance ◆ = Acceptable

Style: 1766
Straight Flute
Note

Tolerances for Series DM Drills:
 Cutting Diameter: +.000, -.0005
 Shank Diameter: +.0000, -.0005

 ASME
 B94.11M

Carbide

140° 4-Facet

 Helix
 High
 35° to 45°

 Straight
 Shank

 Surface
 Treatment

Bright

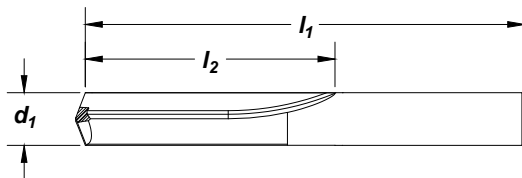

cutting diameter d_1		wire	decimal equivalent	overall length l_1	flute length l_2	order number 1766
fraction						
1/32			.0313	1-1/2	1/2	C89410
		60	.0400	1-1/2	1/2	C89411
		59	.0410	1-1/2	1/2	C89412
		58	.0420	1-1/2	1/2	C89413
		57	.0430	1-1/2	1/2	C89414
3/64		56	.0465	1-1/2	1/2	C89415
			.0469	1-1/2	1/2	C89416
		55	.0520	1-1/2	1/2	C89417
		54	.0550	1-1/2	1/2	C89418
		53	.0595	1-1/2	1/2	C89419
1/16			.0625	1-5/8	5/8	C89420
		52	.0635	1-11/16	11/16	C89421
		51	.0670	1-11/16	11/16	C89422
		50	.0700	1-11/16	11/16	C89423
		49	.0730	1-11/16	11/16	C89424
5/64		48	.0760	1-11/16	11/16	C89425
			.0781	1-11/16	11/16	C89426
		47	.0785	1-3/4	3/4	C89427
		46	.0810	1-3/4	3/4	C89428
		45	.0820	1-3/4	3/4	C89429
3/32		44	.0860	1-3/4	3/4	C89430
		43	.0890	1-3/4	3/4	C89431
		42	.0935	1-3/4	3/4	C89432
			.0938	1-3/4	3/4	C89433
		41	.0960	1-13/16	13/16	C89434
7/64		40	.0980	1-13/16	13/16	C89435
		39	.0995	1-13/16	13/16	C89436
		38	.1015	1-13/16	13/16	C89437
		37	.1040	1-13/16	13/16	C89438
		36	.1065	1-13/16	13/16	C89439
1/8		35	.1094	1-13/16	13/16	C89440
			.1100	1-7/8	7/8	C89441
		34	.1110	1-7/8	7/8	C89442
		33	.1130	1-7/8	7/8	C89443
		32	.1160	1-7/8	7/8	C89444
1/8		31	.1200	1-7/8	7/8	C89445
			.1250	1-7/8	7/8	C89446
		30	.1285	1-15/16	15/16	C89447
		29	.1360	1-15/16	15/16	C89448
		28	.1405	1-15/16	15/16	C89449

continued on next page

Material Reference	Steel (HRC)				Stainless Steel			Cast Iron (HRC)		Aluminum and Non-Ferrous	Hi-Temp Alloy		Hardened Steel (HRC)
	Low Carbon		Alloy		Austenitic	Martensitic	PH	Gray	Nodular		Ni, Co, Fe Based Super Alloy	Titanium	
	Hardness	13-38	>38	16-38	> 38	300 Series	400 series		18-22	22-32			>45
Bright	☆	◆	☆	◆	◆			☆	☆	◆			◆

☆ = Best Performance ◆ = Acceptable

Jobber Length Carbide

Straight Flute

Style: 1766 (continued)

Jobber Length

Carbide

fraction	cutting diameter d ₁		decimal equivalent	overall length l ₁	flute length l ₂	order number
	wire					1766
9/64			.1406	1-15/16	15/16	C89450
		27	.1440	2-1/16	1	C89451
		26	.1470	2-1/16	1	C89452
		25	.1495	2-1/16	1	C89453
		24	.1520	2-1/16	1	C89454
		23	.1540	2-1/16	1	C89455
5/32			.1562	2-1/16	1	C89456
		22	.1570	2-1/8	1-1/16	C89457
		21	.1590	2-1/8	1-1/16	C89458
		20	.1610	2-1/8	1-1/16	C89459
		19	.1660	2-1/8	1-1/16	C89460
		18	.1695	2-1/8	1-1/16	C89461
11/64			.1719	2-1/8	1-1/16	C89462
		17	.1730	2-3/16	1-1/8	C89463
		16	.1770	2-3/16	1-1/8	C89464
		15	.1800	2-3/16	1-1/8	C89465
		14	.1820	2-3/16	1-1/8	C89466
		13	.1850	2-3/16	1-1/8	C89467
3/16			.1875	2-3/16	1-1/8	C89468
		12	.1890	2-1/4	1-3/16	C89469
		11	.1910	2-1/4	1-3/16	C89470
		10	.1935	2-1/4	1-3/16	C89471
		9	.1960	2-1/4	1-3/16	C89472
		8	.1990	2-1/4	1-3/16	C89473
		7	.2010	2-1/4	1-3/16	C89474
13/64			.2031	2-1/4	1-3/16	C89475
		6	.2040	2-3/8	1-1/4	C89476
		5	.2055	2-3/8	1-1/4	C89477
		4	.2090	2-3/8	1-1/4	C89478
		3	.2130	2-3/8	1-1/4	C89479
7/32			.2188	2-3/8	1-1/4	C89480
		2	.2210	2-7/16	1-5/16	C89481
		1	.2280	2-7/16	1-5/16	C89482
15/64			.2344	2-7/16	1-5/16	C89483
1/4			.2500	2-1/2	1-3/8	C89484
17/64			.2656	2-5/8	1-7/16	C89485
9/32			.2812	2-11/16	1-1/2	C89486
19/64			.2969	2-3/4	1-9/16	C89487
5/16			.3125	2-13/16	1-5/8	C89488
21/64			.3281	2-15/16	1-11/16	C89489
11/32			.3438	3	1-11/16	C89490
23/64			.3594	3-1/16	1-3/4	C89491
3/8			.3750	3-1/8	1-13/16	C89492
25/64			.3906	3-1/4	1-7/8	C89493
13/32			.4062	3-5/16	1-15/16	C89494
27/64			.4219	3-3/8	2	C89495
7/16			.4375	3-7/16	2-1/16	C89496
29/64			.4531	3-9/16	2-1/8	C89497
15/32			.4688	3-5/8	2-1/8	C89498
31/64			.4844	3-11/16	2-3/16	C89499
1/2			.5000	3-3/4	2-1/4	C89500

Style: 1727
Heavy Duty
Note

 Operating parameters:
See Technical section

Surface Treatment

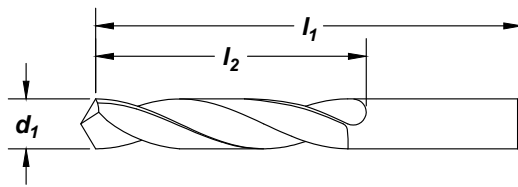
Jobber Length
Carbide
Feature:

Run at 2-3 times SFM over HSS drills.

fraction	drill diameter		decimal equivalent	overall length		flute length		order number
	d_1 wire	mm		l_1 in	mm	l_2 in	mm	
1/32			0.0312	1.250		0.313		C89501
		60	0.0400	1.500		0.750		C89502
		59	0.0410	1.500		0.750		C89503
		58	0.0420	1.500		0.750		C89504
		57	0.0430	1.500		0.750		C89505
		56	0.0465	1.500		0.750		C89506
3/64			0.0469	1.500		0.750		C89507
		55	0.0520	1.500		0.750		C89508
		54	0.0550	1.500		0.750		C89509
		53	0.0595	1.500		0.750		C47517
1/16			0.0625	1.500		0.750		C47519
		52	0.0635	1.500		0.750		C89512
		51	0.0670	1.500		0.750		C89513
		50	0.0700	1.750		0.875		C47526
		49	0.0730	1.750		0.875		C89515
		48	0.0760	1.750		0.875		C89516
5/64			0.0781	1.750		0.875		C89517
		47	0.0785	1.750		0.875		C89518
		46	0.0810	1.750		0.875		C89519
		45	0.0820	1.750		0.875		C89520
		44	0.0860	2.000		1.000		C89521
		43	0.0890	2.000		1.000		C89522
		42	0.0935	2.000		1.000		C89523
3/32			0.0938	2.000		1.000		C47548
		41	0.0960	2.000		1.000		C89525
		40	0.0980	2.000		1.000		C47552
		39	0.0995	2.250		1.250		C89527
		38	0.1015	2.250		1.250		C89528
		37	0.1040	2.250		1.250		C89529
		36	0.1065	2.250		1.250		C89530
7/64			0.1094	2.250		1.250		C47561
		35	0.1100	2.250		1.250		C89532
		34	0.1110	2.250		1.250		C89533
		33	0.1130	2.250		1.250		C89534

continued on next page

Material Reference	Steel (HRc)				Stainless Steel			Cast Iron (HRc)		Aluminum and Non-Ferrous	Hi-Temp Alloy		Hardened Steel (HRc)
	Low Carbon		Alloy		Austenitic	Martensitic	PH	Gray	Nodular		Ni, Co, Fe Based Super Alloy	Titanium	
	Hardness	13-38	>38	16-38	> 38	300 Series	400 series		18-22	22-32			>45
Bright	◆		◆		◆			☆		☆			

☆ = Best Performance ◆ = Acceptable

Heavy Duty

Style: 1727 (continued)

Jobber Length
Carbide

fraction	drill diameter		decimal equivalent	overall length		flute length		order number
	d ₁ wire	mm		I ₁ in	mm	I ₂ in	mm	
	32		0.1160	2.250		1.250		C89535
		3.0	0.1182		61		33	C47239
	31		0.1200	2.250		1.250		C89536
		3.1	0.1221		65		36	C47240
1/8			0.1250	2.250		1.250		C47571
		3.2	0.1260		65		36	C47241
	30		0.1285	2.500		1.375		C47574
		3.3	0.1300		65		36	C47242
		3.4	0.1339		70		39	C47243
	29		0.1360	2.500		1.375		C89539
		3.5	0.1378		70		39	C47244
	28		0.1405	2.500		1.375		C89540
9/64			0.1406	2.500		1.375		C47580
	27		0.1440	2.500		1.375		C47582
	26		0.1470	2.500		1.375		C89543
	25		0.1495	2.500		1.375		C89544
	24		0.1520	2.500		1.375		C89545
	23		0.1540	2.500		1.375		C89546
5/32			0.1562	2.500		1.375		C47591
	22		0.1570	2.500		1.375		C89548
		4.0	0.1575		75		43	C47245
	21		0.1590	2.500		1.375		C89549
	20		0.1610	2.500		1.375		C89550
		4.5	0.1615		80		47	C47246
	19		0.1660	2.750		1.625		C89551
	18		0.1695	2.750		1.625		C89552
11/64			0.1719	2.750		1.625		C47602
	17		0.1730	2.750		1.625		C89554
	16		0.1770	2.750		1.625		C89555
	15		0.1800	2.750		1.625		C89556
	14		0.1820	2.750		1.625		C89557
	13		0.1850	2.750		1.625		C89558
3/16			0.1875	2.750		1.625		C47613
	12		0.1890	2.750		1.625		C89560
	11		0.1910	2.750		1.625		C89561
	10		0.1935	2.750		1.625		C47618
	9		0.1960	3.000		1.750		C89563
		5.0	0.1969		86		52	C47247
	8		0.1990	3.000		1.750		C89564
	7		0.2010	3.000		1.750		C47623
13/64			0.2031	3.000		1.750		C89566
	6		0.2040	3.000		1.750		C47625
	5		0.2055	3.000		1.750		C89568
	4		0.2090	3.000		1.750		C89569
	3		0.2130	3.000		1.750		C89570
		5.5	0.2166		93		57	C47248
7/32			0.2188	3.000		1.750		C47634
	2		0.2210	3.000		1.750		C89572
	1		0.2280	3.000		1.750		C89573
	A		0.2340	3.250		2.000		C89574
15/64			0.2344	3.250		2.000		C89575
		6.0	0.2363		93		57	C47249
	B		0.2380	3.250		2.000		C89576
	C		0.2420	3.250		2.000		C89577
	D		0.2460	3.250		2.000		C89578
1/4	E		0.2500	3.250		2.000		C47648

continued on next page

Style: 1727 (continued)
Heavy Duty
Jobber Length
Carbide

fraction	drill diameter d ₁		decimal equivalent	overall length l ₁		flute length l ₂		order number 1727
	wire	mm		in	mm	in	mm	
		6.5	0.2560		101		63	C47250
	F		0.2570	3.250		2.000		C89580
	G		0.2610	3.500		2.125		C89581
17/64			0.2656	3.500		2.125		C89582
	H		0.2660	3.500		2.125		C89583
	I		0.2720	3.500		2.125		C89584
		7.0	0.2756		109		69	C47251
	J		0.2770	3.500		2.125		C89585
	K		0.2810	3.500		2.125		C89586
9/32			0.2812	3.500		2.125		C89587
	L		0.2900	3.500		2.125		C89588
	M		0.2950	4.000		2.375		C89589
		7.5	0.2953		109		69	C47252
19/64			0.2969	4.000		2.375		C89590
	N		0.3020	4.000		2.375		C89591
5/16			0.3125	4.000		2.375		C47671
		8.0	0.3150		117		75	C47253
	O		0.3160	4.000		2.375		C89593
	P		0.3230	4.000		2.375		C89594
21/64			0.3281	4.000		2.500		C89595
	Q		0.3320	4.000		2.500		C89596
		8.5	0.3347		117		75	C47254
11/32			0.3438	4.000		2.500		C89597
	S		0.3480	4.000		2.500		C89598
		9.0	0.3544		125		81	C47255
	T		0.3580	4.000		2.500		C89599
23/64			0.3594	4.250		2.750		C89600
	U		0.3680	4.250		2.750		C89601
		9.5	0.3741		125		81	C47256
3/8			0.3750	4.250		2.750		C47694
	V		0.3770	4.250		2.750		C89603
	W		0.3860	4.500		2.875		C89604
25/64			0.3906	4.500		2.875		C89605
		10.0	0.3938		133		87	C47257
	X		0.3970	4.500		2.875		C89606
	Y		0.4040	4.500		2.875		C89607
13/32			0.4062	4.500		2.875		C89608
	Z		0.4130	4.500		2.875		C89609
		10.5	0.4134		133		87	C47258
27/64			0.4219	4.500		2.875		C89610
		11.0	0.4331		142		94	C47259
7/16			0.4375	4.500		2.875		C47708
		11.5	0.4528		142		94	C47260
29/64			0.4531	4.750		3.000		C89612
15/32			0.4688	4.750		3.000		C89613
		12.0	0.4725		151		101	C47261
31/64			0.4844	4.750		3.000		C89614
1/2			0.5000	4.750		3.000		C47718

Material Reference	Steel (HRC)				Stainless Steel			Cast Iron (HRC)		Aluminum and Non-Ferrous	Hi-Temp Alloy		Hardened Steel (HRC)
	Low Carbon		Alloy		Austenitic	Martensitic	PH	Gray	Nodular		Ni, Co, Fe Based Super Alloy	Titanium	
	Hardness	13-38	>38	16-38	> 38	300 Series	400 series		18-22	22-32			>45
Bright	◆		◆		◆			☆		☆			

☆ = Best Performance ◆ = Acceptable

NEW

Carbide
Common Shank 3xD

Style: **6100**

Common Shank

External Coolant - Single Margin

Note

- Made From Ultra Fine Grain Carbide
- Polished Flutes
- Defined Edge Geometry (Pre-Coat)
- 140° Self Starting Point
- Coating - Advanced AlTiN
- 0.02mm (0.0008") Maximum Concentricity Shank to Din 6535 HA (h6 tolerance)
- Drill diameter tolerance = h7
- See Technical section for Drilling Method & Speeds & Feeds

Surface Treatment

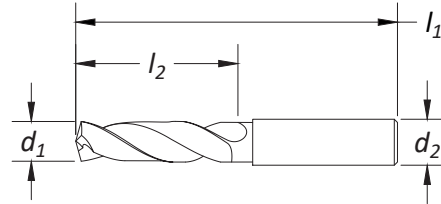

drill diameter		shank diameter		overall length	flute length	order number	
d ₁		d ₂		l ₁ (in)	l ₂ (in)	6100	
in	metric	decimal equiv.	dia Ø	dec. equiv.			
1/8	3.00	0.1181	6.00	0.2362	2.441	0.787	C92500
	3.18	0.1250	6.00	0.2362	2.441	0.787	C92501
	3.30	0.1299	6.00	0.2362	2.441	0.787	C92502
	3.80	0.1496	6.00	0.2362	2.598	0.945	C92503
5/32	3.97	0.1563	6.00	0.2362	2.598	0.945	C92504
	4.20	0.1654	6.00	0.2362	2.598	0.945	C92505
3/16	4.76	0.1875	6.00	0.2362	2.598	0.945	C92506
	5.00	0.1969	6.00	0.2362	2.598	1.102	C92507
	5.10	0.2008	6.00	0.2362	2.598	1.102	C92508
7/32	5.56	0.2188	6.00	0.2362	2.598	1.102	C92509
	5.50	0.2165	6.00	0.2362	2.598	1.102	C92510
	5.80	0.2283	6.00	0.2362	2.598	1.102	C92511
	6.00	0.2362	6.00	0.2362	2.598	1.102	C92512
1/4	6.35	0.2500	8.00	0.3150	3.110	1.457	C92513
	6.50	0.2559	8.00	0.3150	3.110	1.339	C92514
	6.70	0.2638	8.00	0.3150	3.110	1.339	C92515
	6.80	0.2677	8.00	0.3150	3.110	1.339	C92516
	7.00	0.2756	8.00	0.3150	3.110	1.339	C92517
9/32	7.15	0.2812	8.00	0.3150	3.110	1.339	C92518
	7.50	0.2953	8.00	0.3150	3.110	1.339	C92642
5/16	7.94	0.3125	8.00	0.3150	3.110	1.339	C92519
	8.00	0.3150	8.00	0.3150	3.110	1.339	C92520
	8.50	0.3346	10.00	0.3937	3.504	1.850	C92521
11/32	8.73	0.3438	10.00	0.3937	3.504	1.850	C92522
	9.00	0.3543	10.00	0.3937	3.504	1.850	C92523
3/8	9.53	0.3750	10.00	0.3937	3.504	1.850	C92524
	10.00	0.3937	10.00	0.3937	3.504	1.850	C92525
	10.20	0.4016	12.00	0.4724	4.016	2.165	C92526
13/32	10.32	0.4063	12.00	0.4724	4.016	2.165	C92527
	10.50	0.4134	12.00	0.4724	4.016	2.165	C92528
	11.00	0.4331	12.00	0.4724	4.016	2.165	C92529
7/16	11.11	0.4375	12.00	0.4724	4.016	2.165	C92530
	12.00	0.4724	12.00	0.4724	4.016	2.165	C92531
	12.50	0.4921	14.00	0.5512	4.213	2.362	C92532
1/2	12.70	0.5000	14.00	0.5512	4.213	2.362	C92533
	13.00	0.5118	14.00	0.5512	4.213	2.362	C92534
	13.50	0.5315	14.00	0.5512	4.213	2.362	C92535
	14.00	0.5512	14.00	0.5512	4.213	2.362	C92536

Material Reference	Steel (HRc)		Stainless Steel			Cast Iron (HRc)		Aluminum and Non-Ferrous	Hi-Temp Alloy		Hardened Steel (HRc)
	Low Carbon	Alloy	Austenitic	Martensitic	PH	Gray	Nodular		Ni, Co, Fe Based Super Alloy	Titanium	
Hardness	13-38	>38	16-38	> 38	300 Series	400 series					>45
AITiN											

☆ = Best Performance ◆ = Acceptable

Internal Coolant - Single Margin

Surface Treatment



Note

- Made From Ultra Fine Grain Carbide
- Polished Flutes
- Defined Edge Geometry (Pre-Coat)
- 140° Self Starting Point
- Coating - Advanced AITIN
- 0.02mm (0.0008") Maximum Concentricity
- Shank to Din 6535 HA (h6 tolerance)
- Drill diameter tolerance = h7
- See Technical section for Drilling Method & Speeds & Feeds

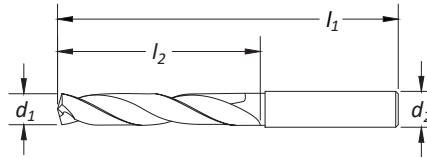

drill diameter			shank diameter		overall length	flute length	order number
d1		decimal equiv.	d2		l1 (in)	l2 (in)	6200
in	metric		dia Ø	dec. equiv.			
1/8	3.00	0.1181	6.00	0.2362	2.598	1.102	C92537
	3.18	0.1250	6.00	0.2362	2.598	1.102	C92538
	3.30	0.1299	6.00	0.2362	2.598	1.102	C92539
	4.00	0.1575	6.00	0.2362	2.913	1.417	C92540
	4.20	0.1654	6.00	0.2362	2.913	1.417	C92541
	4.50	0.1772	6.00	0.2362	2.913	1.417	C92542
3/16	4.76	0.1875	6.00	0.2362	3.228	1.732	C92543
	5.00	0.1969	6.00	0.2362	3.228	1.732	C92544
	5.10	0.2008	6.00	0.2362	3.228	1.732	C92545
	5.50	0.2165	6.00	0.2362	3.228	1.732	C92546
	6.00	0.2362	6.00	0.2362	3.228	1.732	C92547
1/4	6.35	0.2500	8.00	0.3150	3.583	2.087	C92548
	6.50	0.2559	8.00	0.3150	3.583	2.087	C92549
	6.80	0.2677	8.00	0.3150	3.583	2.087	C92550
	7.00	0.2756	8.00	0.3150	3.583	2.087	C92551
9/32	7.15	0.2812	8.00	0.3150	3.583	2.087	C92552
	7.50	0.2953	8.00	0.3150	3.583	2.087	C92643
5/16	7.94	0.3125	8.00	0.3150	3.583	2.087	C92553
	8.00	0.3150	8.00	0.3150	3.583	2.087	C92554
21/64	8.33	0.3281	10.00	0.3937	3.583	2.087	C92555
	8.50	0.3346	10.00	0.3937	4.055	2.402	C92556
	9.00	0.3543	10.00	0.3937	4.055	2.402	C92557
	9.40	0.3701	10.00	0.3937	4.055	2.402	C92558
3/8	9.53	0.3750	10.00	0.3937	4.055	2.402	C92559
	9.90	0.3898	10.00	0.3937	4.055	2.402	C92560
	10.00	0.3937	10.00	0.3937	4.055	2.402	C92561
	10.20	0.4016	12.00	0.4724	4.646	2.795	C92562
13/32	10.32	0.4063	12.00	0.4724	4.646	2.795	C92563
	10.50	0.4134	12.00	0.4724	4.646	2.795	C92564
	10.70	0.4213	12.00	0.4724	4.646	2.795	C92565
	11.00	0.4331	12.00	0.4724	4.646	2.795	C92566
7/16	11.11	0.4375	12.00	0.4724	4.646	2.795	C92567
	11.60	0.4567	12.00	0.4724	4.646	2.795	C92568
	12.00	0.4724	12.00	0.4724	4.646	2.795	C92569
31/64	12.30	0.4844	14.00	0.5512	4.882	3.031	C92570
	12.50	0.4921	14.00	0.5512	4.882	3.031	C92571
1/2	12.70	0.5000	14.00	0.5512	4.882	3.031	C92572
	13.00	0.5118	14.00	0.5512	4.882	3.031	C92573
	13.50	0.5315	14.00	0.5512	4.882	3.031	C92574
	14.00	0.5512	14.00	0.5512	4.882	3.031	C92575
	14.50	0.5709	16.00	0.6299	5.236	3.268	C92576
	14.70	0.5787	16.00	0.6299	5.236	3.268	C92577
	15.00	0.5906	16.00	0.6299	5.236	3.268	C92578
	15.50	0.6102	16.00	0.6299	5.236	3.268	C92579
	15.80	0.6220	16.00	0.6299	5.236	3.268	C92580
5/8	15.88	0.6250	16.00	0.6299	5.236	3.268	C92581

Material Reference	Steel (HRC)		Stainless Steel			Cast Iron (HRC)		Aluminum and Non-Ferrous	Hi-Temp Alloy		Hardened Steel (HRC)
	Low Carbon	Alloy	Austenitic	Martensitic	PH	Gray	Nodular		Ni, Co, Fe Based Super Alloy	Titanium	
	Hardness	13-38	>38	16-38	> 38	300 Series	400 series		18-22	22-32	
AITIN											

☆ = Best Performance ◆ = Acceptable

NEW

Carbide
Common Shank 8xD

Style: **6300**

Common Shank

Carbide

Internal Coolant - Double Margin

Note

Made From Ultra Fine Grain Carbide

Polished Flutes

Defined Edge Geometry (Pre-Coat)

140° Self Starting Point

Coating - Advanced AITiN

0.02mm (0.0008") Maximum Concentricity

Shank to Din 6535 HA (h6 tolerance)

Drill diameter tolerance = h7

See Technical section for Drilling Method & Speeds & Feeds

Surface Treatment

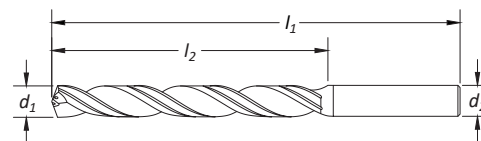

drill diameter			shank diameter		overall length	flute length	order number
d1		decimal equiv.	d2		l1 (in)	l2 (in)	6300
in	metric		dia Ø	dec. equiv.			
	4.00	0.1575	6.00	0.2362	3.150	1.654	C92582
	4.50	0.1772	6.00	0.2362	3.150	1.654	C92583
3/16	4.76	0.1875	6.00	0.2362	3.622	2.126	C92584
	5.00	0.1969	6.00	0.2362	3.622	2.126	C92585
	5.50	0.2165	6.00	0.2362	3.622	2.126	C92586
	6.00	0.2362	6.00	0.2362	3.622	2.126	C92587
1/4	6.35	0.2500	8.00	0.3150	3.937	2.441	C92588
	6.50	0.2559	8.00	0.3150	3.937	2.441	C92589
	6.80	0.2677	8.00	0.3150	3.937	2.441	C92590
	7.00	0.2756	8.00	0.3150	4.252	2.756	C92591
9/32	7.15	0.2812	8.00	0.3150	4.252	2.756	C92592
	7.50	0.2953	8.00	0.3150	4.252	2.756	C92593
5/16	7.94	0.3125	8.00	0.3150	4.252	2.756	C92594
	8.00	0.3150	8.00	0.3150	4.252	2.756	C92595
	8.50	0.3346	10.00	0.3937	4.803	3.150	C92596
	9.00	0.3543	10.00	0.3937	4.803	3.150	C92597
	9.50	0.3740	11.00	0.4331	5.118	3.465	C92598
3/8	9.53	0.3750	10.00	0.3937	5.118	3.465	C92599
	10.00	0.3937	10.00	0.3937	5.118	3.465	C92600
	10.20	0.4016	12.00	0.4724	5.984	4.134	C92601
	10.50	0.4134	12.00	0.4724	5.984	4.134	C92602
	11.00	0.4331	12.00	0.4724	5.984	4.134	C92603
7/16	11.11	0.4375	12.00	0.4724	5.984	4.134	C92604
	11.80	0.4646	12.00	0.4724	5.984	4.134	C92605
	12.00	0.4724	12.00	0.4724	5.984	4.134	C92606
	12.50	0.4921	14.00	0.5512	6.693	4.843	C92607
1/2	12.70	0.5000	14.00	0.5512	6.693	4.843	C92608
	13.00	0.5118	14.00	0.5512	6.693	4.843	C92609
	13.50	0.5315	14.00	0.5512	6.693	4.843	C92610
	14.00	0.5512	14.00	0.5512	6.693	4.843	C92611

Material Reference	Steel (HRc)				Stainless Steel			Cast Iron (HRc)		Aluminum and Non-Ferrous	Hi-Temp Alloy		Hardened Steel (HRc)
	Low Carbon		Alloy		Austenitic	Martensitic	PH	Gray	Nodular		Ni, Co, Fe Based Super Alloy	Titanium	
Hardness	13-38	>38	16-38	> 38	300 Series	400 series		18-22	22-32				>45
AITiN													

☆ = Best Performance ◆ = Acceptable

Internal Coolant - Double Margin

Note

- Made From Ultra Fine Grain Carbide
- Polished Flutes
- Defined Edge Geometry (Pre-Coat)
- 140° Self Starting Point
- Coating - Advanced AITiN
- 0.02mm (0.0008") Maximum Concentricity Shank to Din 6535 HA (h6 tolerance)
- Drill diameter tolerance = h7
- See Technical section for Drilling Method & Speeds & Feeds

Surface Treatment

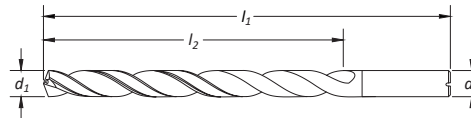
 A starter drill must be used.
 See style: 6100 (3xD) as a starter for this item.

Common Shank

Carbide

drill diameter		decimal		shank diameter		overall length	flute length	order number
d1		equiv.	equiv.	dia Ø	dec. equiv.	I1 (in)	I2 (in)	6400
in	metric							
	4.00	0.1575	6.00	0.2362	4.016	2.520	C92612	
	4.50	0.1772	6.00	0.2362	4.016	2.520	C92613	
3/16	4.76	0.1875	6.00	0.2362	4.567	3.071	C92614	
	5.00	0.1969	6.00	0.2362	4.567	3.071	C92615	
	5.50	0.2165	6.00	0.2362	4.567	3.071	C92616	
	6.00	0.2362	6.00	0.2362	4.567	3.071	C92617	
1/4	6.35	0.2500	8.00	0.3150	5.748	4.252	C92618	
	6.50	0.2559	8.00	0.3150	5.748	4.252	C92619	
	6.80	0.2677	8.00	0.3150	5.748	4.252	C92620	
	7.00	0.2756	8.00	0.3150	5.748	4.252	C92621	
9/32	7.14	0.2812	8.00	0.3150	5.748	4.252	C92622	
	7.50	0.2953	8.00	0.3150	5.748	4.252	C92623	
5/16	7.94	0.3125	8.00	0.3150	5.748	4.252	C92624	
	8.00	0.3150	8.00	0.3150	5.748	4.252	C92625	
	8.50	0.3346	10.00	0.3937	6.378	4.724	C92626	
	9.00	0.3543	10.00	0.3937	6.378	4.724	C92627	
	9.50	0.3740	11.00	0.4331	6.378	4.724	C92628	
3/8	9.53	0.3750	10.00	0.3937	6.378	4.724	C92629	
	10.00	0.3937	10.00	0.3937	6.378	4.724	C92630	
	10.20	0.4016	12.00	0.4724	8.031	6.142	C92631	
	10.50	0.4134	12.00	0.4724	8.031	6.142	C92632	
	11.00	0.4331	12.00	0.4724	8.031	6.142	C92633	
7/16	11.11	0.4375	12.00	0.4724	8.031	6.142	C92634	
	11.80	0.4646	12.00	0.4724	8.031	6.142	C92635	
	12.00	0.4724	12.00	0.4724	8.031	6.142	C92636	
	12.50	0.4921	14.00	0.5512	9.055	7.165	C92637	
1/2	12.70	0.5000	14.00	0.5512	9.055	7.165	C92638	
	13.00	0.5118	14.00	0.5512	9.055	7.165	C92639	
	13.50	0.5315	14.00	0.5512	9.055	7.165	C92640	
	14.00	0.5512	14.00	0.5512	9.055	7.165	C92641	

Material Reference	Steel (HRC)				Stainless Steel			Cast Iron (HRC)		Aluminum and Non-Ferrous	Hi-Temp Alloy		Hardened Steel (HRC)
	Low Carbon		Alloy		Austenitic	Martensitic	PH	Gray	Nodular		Ni, Co, Fe Based Super Alloy	Titanium	
Hardness	13-38	>38	16-38	> 38	300 Series	400 series		18-22	22-32			>45	
AITiN													

☆ = Best Performance ◆ = Acceptable

Note
Operating parameters: See Technical section



Surface Treatment



Taper Length

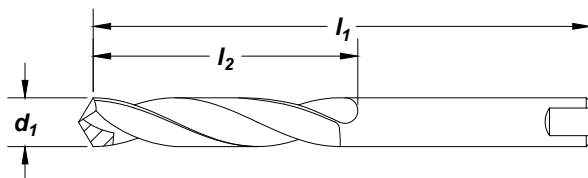

Carbide

Feature:

Run at carbide speeds with the flexibility of a HSS body and shank.

drill diameter d₁	decimal equiv.	overall length l₁ (in)	flute length l₂ (in)	order number 2745
1/8	.1250	5.125	2.750	C49017
5/32	.1562	5.375	3.000	C49029
3/16	.1875	5.750	3.375	C49041
7/32	.2188	6.000	3.625	C49052
1/4	.2500	6.125	3.750	C49064
9/32	.2812	6.250	3.875	C49078
5/16	.3125	6.375	4.000	C49087
11/32	.3438	6.500	4.125	C49098
3/8	.3750	6.750	4.250	C49110
13/32	.4062	7.000	4.375	C49119
27/64	.4219	7.250	4.625	C49121
7/16	.4375	7.250	4.625	C49124
15/32	.4688	7.500	4.750	C49129
1/2	.5000	7.750	4.750	C49134
17/32	.5312	8.000	4.750	C49139
9/16	.5625	8.250	4.875	C49145
5/8	.6250	8.750	4.875	C49155

Tang Specifications

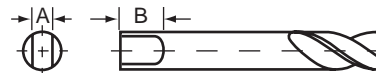

shank diameter (inches)		tang dimensions (inches)	
from	to	width A	width B
1/8	3/16	.092	.281
over 3/16	1/4	.120	.312
over 1/4	5/16	.160	.344
over 5/16	3/8	.201	.375
over 3/8	15/32	.241	.438
over 15/32	9/16	.300	.500
over 9/16	21/32	.370	.563
over 21/32	3/4	.440	.625
over 3/4	7/8	.511	.688
over 7/8	1	.605	.750
over 1	1-3/16	.696	.813
over 1-3/16	1-3/8	.813	.875

Material Reference	Steel (HRc)				Stainless Steel			Cast Iron (HRc)		Aluminum and Non-Ferrous	Hi-Temp Alloy		Hardened Steel (HRc)
	Low Carbon		Alloy		Austenitic	Martensitic	PH	Gray	Nodular		Ni, Co, Fe Based Super Alloy	Titanium	
Hardness	13-38	>38	16-38	> 38	300 Series	400 series		18-22	22-32				>45
Bright	☆		☆					☆	◆	☆			

☆ = Best Performance ◆ = Acceptable

Style: **2510**

General Purpose

Note
Operating parameters: See Technical section

ASME
B94.11M

DIN
340

HSS

118°

Helix
Regular
21° to 34°

Straight
Shank

Surface
Treatment

Black
Oxide

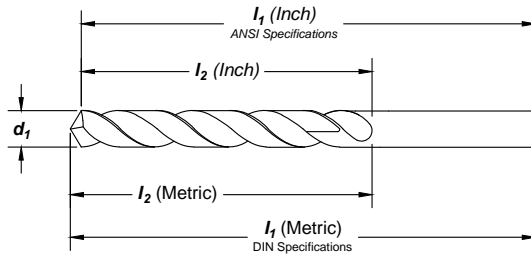

Feature:

General purpose with longer length for added reach.

drill diameter			overall length		flute length		order number
fraction	d ₁ wire	decimal	I ₁		I ₂		2510 black oxide
	mm	equiv.	in	mm	in	mm	
	1.0	.0394		56.00		33.00	C08592
	60	.0400	2.250		1.125		C08593
	59	.0410	2.250		1.125		C08594
	58	.0420	2.250		1.125		C08596
	57	.0430	2.250		1.125		C08597
	56	.0465	2.250		1.125		C08600
3/64		.0469	2.250		1.125		C08601
	1.25	.0492		65.00		41.00	C08603
	55	.0520	3.000		1.750		C08605
	54	.0550	3.000		1.750		C08607
	53	.0595	3.000		1.750		C08611
	1.55	.0610		70.00		45.00	C08612
1/16		.0625	3.000		1.750		C08613
	52	.0635	3.750		2.000		C08615
	51	.0670	3.750		2.000		C08618
	50	.0700	3.750		2.000		C08620
	49	.0730	3.750		2.000		C08623
	48	.0760	3.750		2.000		C08625
5/64		.0781	3.750		2.000		C08627
	47	.0785	4.250		2.250		C08628
	2.0	.0787		85.00		56.00	C08629
	46	.0810	4.250		2.250		C08631
	45	.0820	4.250		2.250		C08632
	44	.0860	4.250		2.250		C08635
	43	.0890	4.250		2.250		C08638
	2.35	.0925		90.00		59.00	C08640
	42	.0935	4.250		2.250		C08641
3/32		.0938	4.250		2.250		C08642
	2.4	.0945		95.00		62.00	C08643
	41	.0960	4.625		2.500		C08644
	40	.0980	4.625		2.500		C08646
	39	.0995	4.625		2.500		C08648
	38	.1015	4.625		2.500		C08649

continued on next page

Material Reference	Steel (HRC)				Stainless Steel			Cast Iron (HRC)		Aluminum and Non-Ferrous	Hi-Temp Alloy		Hardened Steel (HRC)
	Low Carbon		Alloy		Austenitic	Martensitic	PH	Gray	Nodular		Ni, Co, Fe Based Super Alloy	Titanium	
	Hardness	13-38	>38	16-38	> 38	300 Series	400 series		18-22	22-32			>45
	Bright	☆		☆					☆	☆			

☆ = Best Performance ◆ = Acceptable

General Purpose

Style: 2510 (continued)

Taper Length

High Speed Steel

fraction	drill diameter		decimal equiv.	overall length		flute length		order number	
	d ₁ wire	mm		l ₁	mm	l ₂	mm	2510 black oxide	
7/64	37		.1040	4.625		2.500		C08651	
	36		.1065	4.625		2.500		C08653	
	35			.1094	4.625		2.500		C08655
				.1100	5.125		2.750		C08656
		2.8		.1102		100.00		66.00	C08578
				.1110	5.125		2.750		C08658
1/8	34		.1130	5.125		2.750		C08659	
	33		.1160	5.125		2.750		C08661	
	32			.1181		100.00		66.00	C08662
				.1200	5.125		2.750		C08663
		3.0		.1250	5.125		2.750		C08665
				.1260		106.00		69.00	C08666
9/64	30		.1285	5.375		3.000		C08668	
	29		.1299		106.00		69.00	C08669	
	28			.1360	5.375		3.000		C08671
				.1378		112.00		73.00	C08582
		3.2		.1405	5.375		3.000		C08673
				.1406	5.375		3.000		C08674
5/32	27		.1440	5.375		3.000		C08676	
	26		.1470	5.375		3.000		C08678	
	25		.1495	5.375		3.000		C08680	
	24		.1520	5.375		3.000		C08682	
	23			.1540	5.375		3.000		C08684
				.1562	5.375		3.000		C08685
3/16	22		.1570	5.750		3.375		C08686	
		4.0		.1575		119.00		78.00	C08687
	21		.1590	5.750		3.375		C08688	
	20		.1610	5.750		3.375		C08689	
	19			.1654		119.00		78.00	C08587
				.1660	5.750		3.375		C08692
11/64	18		.1695	5.750		3.375		C08695	
	17			.1719	5.750		3.375		C08696
				.1730	5.750		3.375		C08697
	16		.1770	5.750		3.375		C08699	
	15		.1800	5.750		3.375		C08701	
	14		.1820	5.750		3.375		C08703	
7/32	13		.1850	5.750		3.375		C08704	
	12			.1875	5.750		3.375		C08707
				.1890	6.000		3.625		C08708
	11		.1910	6.000		3.625		C08710	
	10		.1935	6.000		3.625		C08712	
	9		.1960	6.000		3.625		C08713	
13/64		5.0	.1969		132.00		87.00	C08714	
	8		.1990	6.000		3.625		C08715	
	7		.2010	6.000		3.625		C08717	
	6			.2031	6.000		3.625		C08718
				.2040	6.000		3.625		C08719
	5		.2055	6.000		3.625		C08721	
15/64	4		.2090	6.000		3.625		C08724	
	3		.2130	6.000		3.625		C08726	
	2			.2188	6.000		3.625		C08728
				.2210	6.125		3.750		C08730
	1		.2280	6.125		3.750		C08733	
		5.8		.2283		139.00		91.00	C08608
	5.9		.2323		139.00		91.00	C08735	
15/64			.2344	6.125		3.750		C08737	

continued on next page

Style: 2510 (continued)
General Purpose

drill diameter		overall length		flute length		order number		
fraction	d ₁ wire	mm	decimal equiv.	in	mm	in	mm	2510 black oxide
		6.0	.2362		139.00		91.00	C08738
	D		.2460	6.125		3.750		C08743
		6.3	.2480		148.00		97.00	C08745
1/4	E		.2500	6.125		3.750		C08746
		6.5	.2559		148.00		97.00	C08749
	F		.2570	6.250		3.875		C08750
17/64			.2656	6.250		3.875		C08752
		6.8	.2677		156.00		102.00	C08755
	I		.2720	6.250		3.875		C08757
		7.0	.2756		156.00		102.00	C08758
	J		.2770	6.250		3.875		C08759
9/32			.2812	6.250		3.875		C08766
		7.5	.2953		156.00		102.00	C08609
19/64			.2969	6.375		4.000		C08770
	N		.3020	6.375		4.000		C08772
5/16			.3125	6.375		4.000		C08777
		8.0	.3150		165.00		109.00	C08778
	O		.3160	6.500		4.125		C08779
	P		.3230	6.500		4.125		C08782
21/64			.3281	6.500		4.125		C08785
	Q		.3320	6.500		4.125		C08787
		8.5	.3346		165.00		109.00	C08788
	R		.3390	6.500		4.125		C08790
11/32			.3438	6.500		4.125		C08792
		9.0	.3543		175.00		115.00	C08797
23/64			.3594	6.750		4.250		C08800
3/8			.3750	6.750		4.250		C08807
	V		.3770	7.000		4.375		C08808
25/64			.3906	7.000		4.375		C08815
		10.0	.3937		184.00		121.00	C08816
		10.2	.4016		184.00		121.00	C08818
13/32			.4062	7.000		4.375		C08821
		10.5	.4134		184.00		121.00	C08823
27/64			.4219	7.250		4.625		C08824
		11.0	.4331		195.00		128.00	C08826
7/16			.4375	7.250		4.625		C08827
		11.2	.4409		195.00		128.00	C08828
29/64			.4531	7.500		4.750		C08830
15/32			.4688	7.500	190.50	4.750	120.65	C08832
		12.0	.4724		205.00		134.00	C08833
31/64			.4844	7.750		4.750		C08835
		12.5	.4921		205.00		134.00	C08610
1/2			.5000	7.750		4.750		C08837
		13.0	.5118		205.00		134.00	C08839
33/64			.5156	8.000		4.750		C08840
17/32			.5312	8.000		4.750		C08842
35/64			.5469	8.250		4.875		C08845

Taper Length
High Speed Steel
continued on next page

Material Reference	Steel (HRC)				Stainless Steel			Cast Iron (HRC)		Aluminum and Non-Ferrous	Hi-Temp Alloy		Hardened Steel (HRC)
	Low Carbon		Alloy		Austenitic	Martensitic	PH	Gray	Nodular		Ni, Co, Fe Based Super Alloy	Titanium	
	Hardness	13-38	>38	16-38	> 38	300 Series	400 series		18-22	22-32			>45
Bright	☆		☆					☆	☆				

☆ = Best Performance ◆ = Acceptable

General Purpose

Style: 2510 (continued)

Taper Length

High Speed Steel

drill diameter		overall length				flute length		order number
fraction	d ₁	mm	decimal equiv.	l ₁		l ₂		2510 black oxide
	wire			in	mm	in	mm	
		14.0	.5512		214.00		140.00	C08846
9/16			.5625	8.250		4.875		C08848
37/64			.5781	8.750		4.875		C08850
		15.0	.5906		220.00		144.00	C08852
19/32			.5938	8.750		4.875		C08853
39/64			.6094	8.750		4.875		C08855
5/8			.6250	8.750		4.875		C08858
		16.0	.6299		227.00		149.00	C08859
41/64			.6406	9.000		5.125		C08861
21/32			.6562	9.000		5.125		C08863
		17.0	.6693		235.00		149.00	C08865
43/64			.6719	9.250		5.375		C08866
11/16			.6875	9.250		5.375		C08868
45/64			.7031	9.500		5.625		C08870
		18.0	.7087		241.00		143.00	C08871
23/32			.7188	9.500		5.625		C08872
47/64			.7344	9.750		5.875		C08874
3/4			.7500	9.750		5.875		C08876
49/64			.7656	9.875		6.000		C08877
25/32			.7812	9.875		6.000		C08879
		20.0	.7874		254.00		156.00	C08880
51/64			.7969	10.000		6.125		C08881
13/16			.8125	10.000		6.125		C08883
53/64			.8281	10.000		6.125		C08885
27/32			.8438	10.000		6.125		C08886
55/64			.8594	10.000		6.125		C08888
7/8			.8750	10.000		6.125		C08890
57/64			.8906	10.000		6.125		C08892
29/32			.9062	10.000		6.125		C08894
59/64			.9219	10.750		6.125		C08895
15/16			.9375	10.750		6.125		C08897
61/64			.9531	11.000		6.375		C08899
31/32			.9688	11.000		6.375		C08901
63/64			.9844	11.000		6.375		C08903
1			1.0000	11.000		6.375		C08904

General Purpose

SET

Style: 2510

no. of pieces	surface treatment	size range	order number
29	black oxide	1/16" through 1/2" x 1/64"	2510 C00962



Material Reference	Steel (HRc)				Stainless Steel			Cast Iron (HRc)		Aluminum and Non-Ferrous	Hi-Temp Alloy		Hardened Steel (HRc)
	Low Carbon		Alloy		Austenitic	Martensitic	PH	Gray	Nodular		Ni, Co, Fe Based Super Alloy	Titanium	
	Hardness				300 Series	400 series		18-22	22-32				
Bright	☆		☆					☆	☆				

☆ = Best Performance ◆ = Acceptable

Style: 2550
High Helix

Note
Operating parameters: See Technical section

 ASME
B94.11M

HSS

118°

 Helix
High
35° to 45°

 Straight
Shank

 Surface
Treatment

Bright

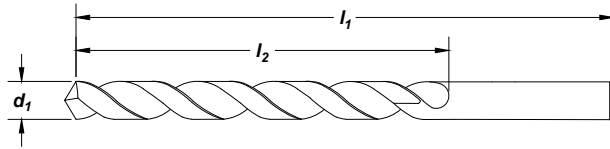
Taper Length
High Speed Steel
Feature:

Fast spiral aids chip removal in softer materials.

fraction	drill diameter		decimal equiv.	overall length		flute length		order number
	d ₁	wire		l ₁ (in)	l ₂ (in)	2550		
1/32		60	.0312	1.625	.750		C09060	
		57	.0400	2.250	1.125		C09062	
		56	.0430	2.250	1.125		C09066	
3/64		56	.0465	2.250	1.125		C09069	
		55	.0469	2.250	1.125		C09070	
		55	.0520	3.000	1.750		C09074	
1/16		54	.0550	3.000	1.750		C09076	
		53	.0595	3.000	1.750		C09080	
		53	.0625	3.000	1.750		C09082	
5/64		51	.0670	3.750	2.000		C09087	
		50	.0700	3.750	2.000		C09089	
		49	.0730	3.750	2.000		C09092	
		48	.0760	3.750	2.000		C09094	
		48	.0781	3.750	2.000		C09096	
3/32		47	.0785	4.250	2.250		C09097	
		46	.0810	4.250	2.250		C09100	
		46	.0820	4.250	2.250		C09101	
		44	.0860	4.250	2.250		C09104	
		43	.0890	4.250	2.250		C09107	
		42	.0935	4.250	2.250		C09110	
		42	.0938	4.250	2.250		C09111	
		41	.0960	4.625	2.500		C09113	
7/64		40	.0980	4.625	2.500		C09115	
		39	.0995	4.625	2.500		C09117	
		38	.1015	4.625	2.500		C09118	
		37	.1040	4.625	2.500		C09120	
		36	.1065	4.625	2.500		C09122	
1/8		35	.1094	4.625	2.500		C09124	
		35	.1100	5.125	2.750		C09125	
		33	.1130	5.125	2.750		C09128	
		32	.1160	5.125	2.750		C09130	
1/8		31	.1200	5.125	2.750		C09132	
		31	.1250	5.125	2.750		C09134	
	30	.1285	5.375	3.000		C09137		

continued on next page

Material Reference	Steel (HRC)				Stainless Steel			Cast Iron (HRC)		Aluminum and Non-Ferrous	Hi-Temp Alloy		Hardened Steel (HRC)
	Low Carbon		Alloy		Austenitic	Martensitic	PH	Gray	Nodular		Ni, Co, Fe Based Super Alloy	Titanium	
Hardness	13-38	>38	16-38	> 38	300 Series	400 series		18-22	22-32			>45	
Bright	◆		☆							☆			

☆ = Best Performance ◆ = Acceptable

High Helix

Style: **2550** (continued)

Taper Length
High Speed Steel

fraction	drill diameter		decimal equiv.	overall length		flute length		order number
	d ₁	wire		l ₁ (in)	l ₂ (in)	2550		
		29	.1360	5.375	3.000	C09140		
9/64			.1406	5.375	3.000	C09143		
		27	.1440	5.375	3.000	C09145		
		26	.1470	5.375	3.000	C09147		
5/32			.1562	5.375	3.000	C09154		
		21	.1590	5.750	3.375	C09157		
		20	.1610	5.750	3.375	C09158		
11/64			.1719	5.750	3.375	C09165		
		16	.1770	5.750	3.375	C09168		
		15	.1800	5.750	3.375	C09170		
3/16			.1875	5.750	3.375	C09176		
		11	.1910	6.000	3.625	C09179		
		10	.1935	6.000	3.625	C09181		
		8	.1990	6.000	3.625	C09184		
		7	.2010	6.000	3.625	C09186		
13/64			.2031	6.000	3.625	C09187		
		3	.2130	6.000	3.625	C09195		
7/32			.2188	6.000	3.625	C09197		
		1	.2280	6.125	3.750	C09202		
15/64			.2344	6.125	3.750	C09205		
1/4			.2500	6.125	3.750	C09211		
5/16			.3125	6.375	4.000	C09234		
3/8			.3750	6.750	4.250	C09257		
7/16			.4375	7.250	4.625	C09271		
1/2			.5000	7.750	4.750	C09281		

Material Reference	Steel (HRc)				Stainless Steel			Cast Iron (HRc)		Aluminum and Non-Ferrous	Hi-Temp Alloy		Hardened Steel (HRc)
	Low Carbon		Alloy		Austenitic	Martensitic	PH	Gray	Nodular		Ni, Co, Fe Based Super Alloy	Titanium	
Hardness	13-38	>38	16-38	> 38	300 Series	400 series		18-22	22-32				>45
Bright	◆		☆							☆			

☆ = Best Performance ◆ = Acceptable

Note
Operating parameters: See Technical section

ASME
B94.11M

M42
Cobalt

118° K-Notch

Helix
Regular
21° to 34°

Straight
Shank Tang

Surface
Treatment

Straw
Oxide

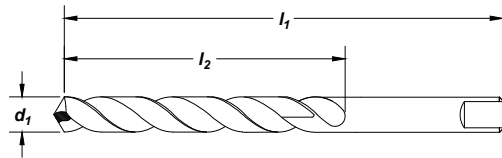

Taper Length

Cobalt

Feature:

Highly heat resistant substrate for tough to machine materials.

drill diameter d₁	decimal equiv.	overall length l₁ (in)	flute length l₂ (in)	order number 2513
1/8	.1250	5.125	3.375	C14873
9/64	.1406	5.375	3.625	C14882
5/32	.1562	5.375	3.750	C14893
3/16	.1875	5.750	4.125	C14915
7/32	.2188	6.000	4.375	C14935
1/4	.2500	6.125	4.813	C14954
9/32	.2812	6.250	5.000	C14973
5/16	.3125	6.375	5.125	C14984
11/32	.3438	6.500	5.250	C14999
23/64	.3594	6.750	5.375	C15007
3/8	.3750	6.750	5.375	C15014
13/32	.4062	7.000	5.625	C15028
27/64	.4219	7.250	5.688	C15031
7/16	.4375	7.250	5.688	C15034
29/64	.4531	7.500	5.750	C15037
15/32	.4688	7.500	5.750	C15039
31/64	.4844	7.750	5.750	C15042
1/2	.5000	7.750	5.750	C15044

Material Reference	Steel (HRC)		Stainless Steel		Cast Iron (HRC)		Aluminum and Non-Ferrous	Hi-Temp Alloy		Hardened Steel (HRC)	
	Low Carbon	Alloy	Austenitic	Martensitic	PH	Gray		Nodular	Ni, Co, Fe Based Super Alloy		Titanium
	Hardness	13-38	>38	16-38	> 38	300 Series	400 series		18-22	22-32	
Straw	◆		☆		◆	☆		◆	☆		

☆ = Best Performance ◆ = Acceptable

Note
Operating parameters: See Technical section

ASME
B94.11M

HSS

118° K-Notch

Helix
Regular
21° to 34°

Straight
Shank Tang

Surface
Treatment

Black
Oxide

Taper Length

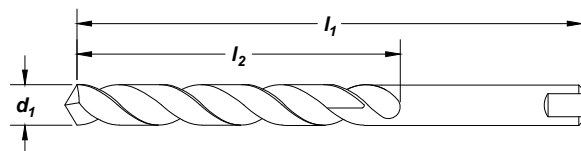

High Speed Steel

Feature:
Heavy duty design with long length for extended reach application.

drill diameter	decimal	overall length	flute length	order number
d_1	equiv.	l_1 (in)	l_2 (in)	2540
1/8	.1250	5.125	3.375	C09443
5/32	.1562	5.375	3.750	C09455
3/16	.1875	5.750	4.125	C09467
7/32	.2188	6.000	4.375	C09478
1/4	.2500	6.125	4.813	C09490
9/32	.2812	6.250	5.000	C09504
5/16	.3125	6.375	5.125	C09513
11/32	.3438	6.500	5.250	C09524
3/8	.3750	6.750	5.375	C09536
13/32	.4062	7.000	5.625	C09545
7/16	.4375	7.250	5.688	C09550
29/64	.4531	7.500	5.750	C09553
15/32	.4688	7.500	5.750	C09555
1/2	.5000	7.750	5.750	C09560
33/64	.5156	8.000	6.000	C09563
17/32	.5312	8.000	6.000	C09565
9/16	.5625	8.250	6.250	C09571
19/32	.5938	8.750	6.500	C09576
5/8	.6250	8.750	6.500	C09581

TECH TIPS

Heavy Duty Automotive Tang Taper Length Drills

- These drills feature a 20% longer flute length than regular taper length drills for increased regrinds and reach.

Material Reference	Steel (HRc)				Stainless Steel			Cast Iron (HRc)		Aluminum and Non-Ferrous	Hi-Temp Alloy		Hardened Steel (HRc)
	Low Carbon		Alloy		Austenitic	Martensitic	PH	Gray	Nodular		Ni, Co, Fe Based Super Alloy	Titanium	
Hardness	13-38	>38	16-38	> 38	300 Series	400 series		18-22	22-32				>45
Black Oxide	★		☆		☆			★	☆				

☆ = Best Performance ★ = Acceptable

Note

Operating parameters: See Technical section
Adjust the parameters as follows:
double the given feed rate.



Surface Treatment

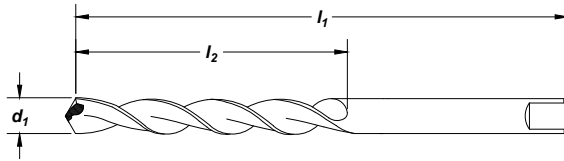

Taper Length

High Speed Steel

Feature:

Excels in deep hole drilling without pecking in softer, free machining materials. Drill up to 10x diameter without pecking. Taper length for extended reach. Standard with automotive tang.

drill diameter		decimal equiv.	overall length		order number	
fraction	wire/let		l_1 (in)	l_2 (in)	2565 bright	2565-TN TiN
1/16		.0625	3.000	1.750	C16058	C05105
	50	.0700	3.750	2.000	C16269	-
5/64	47	.0781	3.750	2.000	C16059	-
	43	.0785	4.250	2.250	C16266	-
	42	.0890	4.250	2.250	C16262	-
3/32		.0935	4.250	2.250	C16261	-
		.0938	4.250	2.250	C16060	C05118
	40	.0980	4.625	2.500	-	C05120
	37	.1040	4.625	2.500	C16256	C05123
7/64	36	.1065	4.625	2.500	C16255	-
		.1094	4.625	2.500	C16061	-
1/8	33	.1130	5.125	2.750	C16252	-
		.1250	5.125	2.750	C16062	C05131
	30	.1285	5.375	3.000	C16249	-
9/64	29	.1360	5.375	3.000	C16248	-
		.1406	5.375	3.000	C16063	-
	26	.1470	5.375	3.000	C16245	-
5/32	25	.1495	5.375	3.000	C16244	-
		.1562	5.375	3.000	C16064	C05141
	21	.1590	5.750	3.375	C16240	-
	20	.1610	5.750	3.375	C16239	-
11/64		.1719	5.750	3.375	C16065	-
	16	.1730	5.750	3.375	C16235	-
	15	.1770	5.750	3.375	C16234	-
	13	.1820	5.750	3.375	-	C05152
3/16		.1875	5.750	3.375	C16066	C05153
	12	.1890	6.000	3.625	-	C05154
	10	.1935	6.000	3.625	C16229	-
	9	.1960	6.000	3.625	C16228	-
	7	.2010	6.000	3.625	C16226	-

continued on next page

Material Reference	Steel (HRC)				Stainless Steel			Cast Iron (HRC)		Aluminum and Non-Ferrous	Hi-Temp Alloy		Hardened Steel (HRC)
	Low Carbon		Alloy		Austenitic	Martensitic	PH	Gray	Nodular		Ni, Co, Fe Based Super Alloy	Titanium	
	Hardness	13-38	>38	16-38	> 38	300 Series	400 series		18-22	22-32			>45
Bright	◆		◆		◆					☆			
TiN	☆		☆		☆								

☆ = Best Performance ◆ = Acceptable

Taper Length

High Speed Steel

drill diameter		decimal equiv.	overall length l ₁ (in)	flute length l ₂ (in)	order number	
fraction	d ₁ wire/let				2565 bright	2565-TN TiN
13/64		.2031	6.000	3.625	C16067	C05160
	3	.2130	6.000	3.625	C16222	-
7/32		.2188	6.000	3.625	C16068	C05165
15/64		.2344	6.125	3.750	C16069	-
1/4	E	.2500	6.125	3.750	C16070	C05173
17/64		.2656	6.250	3.875	C16071	C05176
9/32		.2812	6.250	3.875	C16072	C05181
19/64		.2969	6.375	4.000	C16073	C05184
5/16		.3125	6.375	4.000	C16074	-
21/64		.3281	6.500	4.125	C16075	C05187
11/32		.3438	6.500	4.125	C16076	C05190
23/64		.3594	6.750	4.250	C16077	C05193
3/8		.3750	6.750	4.250	C16078	C05195
25/64		.3906	7.000	4.375	C16079	C05198
13/32		.4062	7.000	4.375	C16080	C05201
27/64		.4219	7.250	4.625	C16081	C05203
7/16		.4375	7.250	4.625	C16082	C05204
29/64		.4531	7.500	4.750	C16083	C05205
15/32		.4688	7.500	4.750	C16084	C05206
31/64		.4844	7.750	4.750	C16085	C05207
1/2		.5000	7.750	4.750	C16086	-

Material Reference	Steel (HRc)				Stainless Steel			Cast Iron (HRc)		Aluminum and Non-Ferrous	Hi-Temp Alloy		Hardened Steel (HRc)
	Low Carbon		Alloy		Austenitic	Martensitic	PH	Gray	Nodular		Ni, Co, Fe Based Super Alloy	Titanium	
Hardness	13-38	>38	16-38	> 38	300 Series	400 series		18-22	22-32			>45	
Bright	◆		◆		◆					☆			
TiN	☆		☆		☆								

☆ = Best Performance ◆ = Acceptable

Styles: **2575, 2575-TN, 2575-TA**

Note
Operating parameters: See Technical section

ASME
B94.11M

DIN
340

M42
Cobalt



Surface
Treatment

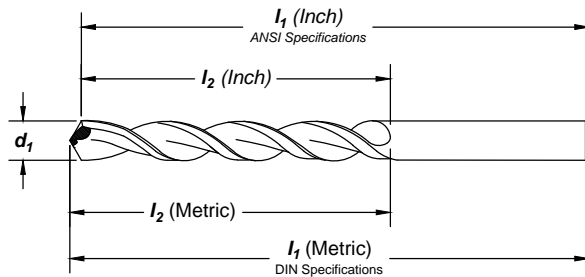

Taper Length

Cobalt

Feature:

Effective deep hole drilling in a wide array of materials. Available coating for extended tool life and productivity. Longer design for deeper holes and extended reach.

drill diameter			overall length		flute length		order number		
fraction	d ₁	decimal equiv.	I ₁		I ₂		2575	2575-TN	2575-TA
	wire/let		in	mm	in	mm	straw oxide	TiN	TiAlN
1/16	*1.50	.0591		76.00		44.00	C16805	C16914	C18805
	52	.0625	3.000		1.750		C16776	C16885	-
5/64	1.70	.0635	3.750		2.000		C16775	C16884	-
		.0669		76.00		50.00	-	-	C18807
	51	.0670	3.750		2.000		C16774	C16883	-
	50	.0700	3.750		2.000		C16773	C16882	-
	49	.0730	3.750		2.000		C16772	C16881	-
	48	.0760	3.750		2.000		C16771	C16880	-
3/32	2.00	.0781	4.250		2.250		C16770	C16879	-
		.0785		108.00		57.00	C16806	C16915	C18810
	46	.0810	4.250		2.250		C16769	C16878	-
	45	.0820	4.250		2.250		C16768	C16877	-
	44	.0860	4.250		2.250		C16767	C16876	-
	43	.0866		90.00		59.00	-	-	C18812
7/64	2.20	.0890	4.250		2.250		C16766	C16875	-
		.0935	4.250		2.250		C16765	C16874	-
	42	.0938	4.250		2.250		C16778	C16887	-
	41	.0960	4.625		2.500		C16764	C16873	-
	40	.0980	4.625		2.500		C16763	C16872	-
	39	.0984		117.00		64.00	C16807	C16916	C18815
1/8	2.50	.0995	4.625		2.500		C16762	C16871	-
		.1015	4.625		2.500		C16761	C16870	-
	38	.1040	4.625		2.500		C16760	C16869	-
	37	.1065	4.625		2.500		C16759	C16868	-
	36	.1094	4.625		2.500		C16779	C16888	-
	35	.1100	5.125		2.750		C16758	C16867	-
3/16	2.75	.1110	5.125		2.750		C16757	C16866	-
		.1130	5.125		2.750		C16756	C16865	-

*Not split point.

continued on next page

Material Reference	Steel (HRC)				Stainless Steel			Cast Iron (HRC)		Aluminum and Non-Ferrous	Hi-Temp Alloy		Hardened Steel (HRC)
	Low Carbon		Alloy		Austenitic	Martensitic	PH	Gray	Nodular		Ni, Co, Fe Based Super Alloy	Titanium	
Hardness	13-38	>38	16-38	> 38	300 Series	400 series		18-22	22-32				>45
Straw										☆			
TiN	◆		◆		◆	◆		◆	◆				
TiAlN	☆		☆		☆	☆		☆	☆				

☆ = Best Performance ◆ = Acceptable

Taper Length

Cobalt

drill diameter		overall length		flute length		order number				
fraction	wire/let	d ₁ mm	decimal equiv.	l ₁ in	l ₁ mm	l ₂ in	l ₂ mm	2575 straw oxide	2575-TN TiN	2575-TA TiAlN
	32		.1160	5.125		2.750		C16755	C16864	-
		3.00	.1181		130.00		70.00	C16808	C16917	-
	31		.1200	5.125		2.750		C16754	C16863	-
1/8			.1250	5.125		2.750		C16780	C16889	-
	30		.1285	5.375		3.000		C16753	C16862	-
	29		.1360	5.375		3.000		C16752	C16861	-
		3.50	.1378		137.00		76.00	C16809	C16918	-
	28		.1405	5.375		3.000		C16751	C16860	-
9/64			.1406	5.375		3.000		C16781	C16890	-
	27		.1440	5.375		3.000		C16750	C16859	-
	26		.1470	5.375		3.000		C16749	C16858	-
	25		.1495	5.375		3.000		C16748	C16857	-
	24		.1520	5.375		3.000		C16747	C16856	-
	23		.1540	5.375		3.000		C16746	C16855	-
5/32			.1562	5.375		3.000		C16782	C16891	-
	22		.1570	5.750		3.375		C16745	C16854	-
		4.00	.1575		146.00		86.00	C16810	C16919	-
	21		.1590	5.750		3.375		C16744	C16853	-
	20		.1610	5.750		3.375		C16743	C16852	-
	19		.1660	5.750		3.375		C16742	C16851	-
	18		.1695	5.750		3.375		C16741	C16850	-
11/64			.1719	5.750		3.375		C16783	C16892	-
	17		.1730	5.750		3.375		C16740	C16849	-
	16		.1770	5.750		3.375		C16739	C16848	-
		4.50	.1772		126.00		82.00	C16811	C16920	-
	15		.1800	5.750		3.375		C16738	C16847	-
	14		.1820	5.750		3.375		C16737	C16846	-
	13		.1850	5.750		3.375		C16736	C16845	-
3/16			.1875	5.750		3.375		C16784	C16893	-
	12		.1890	6.000		3.625		C16735	C16844	-
	11		.1910	6.000		3.625		C16734	C16843	-
	10		.1935	6.000		3.625		C16733	C16842	-
	9		.1960	6.000		3.625		C16732	C16841	-
		5.00	.1969		152.00		92.00	C16812	C16921	-
	8		.1990	6.000		3.625		C16731	C16840	-
	7		.2010	6.000		3.625		C16730	C16839	-
13/64			.2031	6.000		3.625		C16785	C16894	-
	6		.2040	6.000		3.625		C16729	C16838	-
		5.20	.2047		152.00		92.00	C16813	C16922	-
	5		.2055	6.000		3.625		C16728	C16837	-
	4		.2090	6.000		3.625		C16727	C16836	-
	3		.2130	6.000		3.625		C16726	C16835	-
		5.50	.2165		152.00		92.00	C16814	C16923	-
7/32			.2188	6.000		3.625		C16786	C16895	-
		5.60	.2205		156.00		95.00	C16815	C16924	-
	2		.2210	6.125		3.750		C16725	C16834	-
	1		.2280	6.125		3.750		C16724	C16833	-
15/64			.2344	6.125		3.750		C16787	C16896	-
		6.00	.2362		156.00		95.00	C16816	C16925	-
1/4			.2500	6.125		3.750		C16788	C16897	-
		6.50	.2559		159.00		98.00	C16817	C16926	-
17/64			.2656	6.250		3.875		C16789	C16898	-
		6.80	.2677		159.00		98.00	C16818	C16927	-
		7.00	.2756		159.00		98.00	C16819	C16928	-
9/32			.2812	6.250		3.875		C16790	C16899	-

continued on next page

drill diameter			overall length		flute length		order number		
d ₁		decimal	l ₁		l ₂		2575	2575-TN	2575-TA
fraction	wire/let	equiv.	in	mm	in	mm	straw oxide	TiN	TiAlN
		7.50	.2953	162.00		102.00	C16820	C16929	-
19/64		.2969	6.375		4.000		C16791	C16900	-
5/16		.3125	6.375		4.000		C16792	C16901	-
	8.00	.3150		165.00		105.00	C16821	C16930	-
	8.20	.3228		165.00		105.00	C16822	C16931	-
21/64		.3281	6.500		4.125		C16793	C16902	-
	8.50	.3346		165.00		105.00	C16823	C16932	-
	8.60	.3386		165.00		105.00	C16824	C16933	-
11/32		.3438	6.500		4.125		C16794	C16903	-
	9.00	.3543		171.00		108.00	C16825	C16934	-
23/64		.3594	6.750		4.250		C16795	C16904	-
	9.50	.3740		171.00		108.00	C16826	C16935	-
3/8		.3750	6.750		4.250		C16796	C16905	-
25/64		.3906	7.000		4.375		C16797	C16906	-
	10.00	.3937		178.00		111.00	C16827	C16936	-
13/32		.4062	7.000		4.375		C16798	C16907	-
	10.50	.4134		184.00		117.00	C16828	C16937	-
27/64		.4219	7.250		4.625		C16799	C16908	-
	11.00	.4331		184.00		117.00	C16829	C16938	-
7/16		.4375	7.250		4.625		C16800	C16909	-
	11.50	.4528		190.00		121.00	C16830	C16939	-
29/64		.4531	7.500		4.750		C16801	C16910	-
15/32		.4688	7.500		4.750		C16802	C16911	-
	12.00	.4724		190.00		121.00	C16831	C16940	-
31/64		.4844	7.750		4.750		C16803	C16912	-
	12.50	.4921		190.00		121.00	C16832	C16941	-
1/2		.5000	7.750		4.750		C16804	C16913	-

Taper Length

Cobalt

Material Reference	Steel (HRC)				Stainless Steel			Cast Iron (HRC)		Aluminum and Non-Ferrous	Hi-Temp Alloy		Hardened Steel (HRC)
	Low Carbon		Alloy		Austenitic	Martensitic	PH	Gray	Nodular		Ni, Co, Fe Based Super Alloy	Titanium	
	Hardness	13-38	>38	16-38	> 38	300 Series	400 series		18-22	22-32			>45
Straw										☆			
TiN	◆		◆		◆	◆		◆	◆				
TiAlN	☆		☆		☆	☆		☆	☆				

☆ = Best Performance ◆ = Acceptable

Note

Operating parameters: See Technical section



Surface Treatment



Aircraft Extension

High Speed Steel

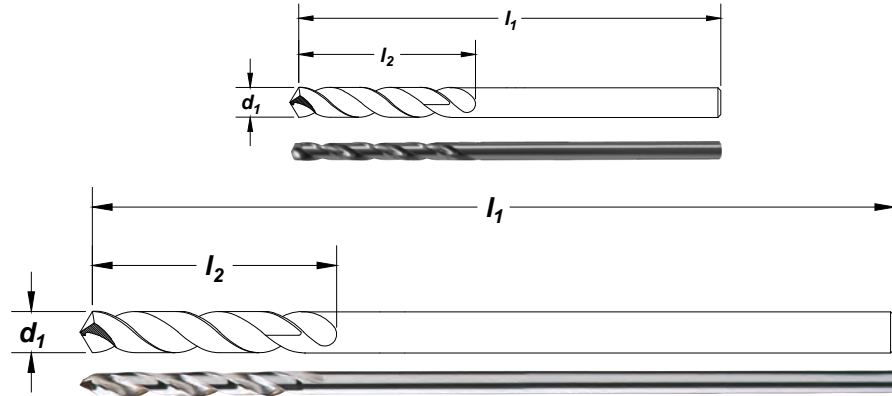

Feature:

Ideal for long reach drilling applications.

drill diameter		decimal equiv.	order number		flute length l ₂ (in)
fraction	d ₁ wire/letter		3957-6 overall length l ₁ (6.0 in)	3957-12 overall length l ₁ (12.0 in)	
*3/64		.0469	C13100	-	.750
1/16		.0625	C13101	C13176	.875
	52	.0635	C13174	-	.875
	51	.0670	C13173	-	1.000
	50	.0700	C13172	-	1.000
	49	.0730	C13171	-	1.000
	48	.0760	C13170	-	1.000
5/64		.0781	C13102	C13177	1.000
	47	.0785	C13169	-	1.125
	46	.0810	C13168	-	1.125
	45	.0820	C13167	-	1.125
	44	.0860	C13166	-	1.250
	43	.0890	C13165	-	1.250
	42	.0935	C13164	-	1.250
3/32		.0938	C13103	C13178	1.250
	41	.0960	C13163	-	1.375
	40	.0980	C13162	C13244	1.375
	39	.0995	C13161	C13243	1.375
	38	.1015	C13160	-	1.438
	37	.1040	C13159	-	1.438
	36	.1065	C13158	-	1.438
7/64		.1094	C13104	C13179	1.500
	35	.1100	C13157	-	1.500
	34	.1110	C13156	-	1.500
	33	.1130	C13155	-	1.500
	32	.1160	C13154	-	1.625
	31	.1200	C13153	C13242	1.625
1/8		.1250	C13105	C13180	1.625
	30	.1285	C13152	C13241	1.625
	29	.1360	C13151	C13240	1.750
	28	.1405	C13150	C13239	1.750
9/64		.1406	C13106	C13181	1.750
	27	.1440	C13149	C13238	1.875
	26	.1470	C13148	C13237	1.875
	25	.1495	C13147	C13236	1.875
	24	.1520	C13146	C13235	2.000
	23	.1540	C13145	-	2.000
5/32		.1562	C13107	C13182	2.000
	22	.1570	C13144	-	2.000
	21	.1590	C13143	C13234	2.125

*Not split point.

continued on next page

drill diameter			order number		
fraction	d ₁ wire/letter	decimal equiv.	overall length		flute length l ₂ (in)
			3957-6 l ₁ (6.0 in)	3957-12 l ₁ (12.0 in)	
	20	.1610	C13142	C13233	2.125
	19	.1660	C13141	C13232	2.125
	18	.1695	C13140	-	2.125
11/64		.1719	C13108	C13183	2.125
	17	.1730	C13139	-	2.188
	16	.1770	C13138	C13231	2.188
	15	.1800	C13137	C13230	2.188
	14	.1820	C13136	-	2.188
	13	.1850	C13135	C13229	2.313
3/16		.1875	C13109	C13184	2.313
	12	.1890	C13134	C13228	2.313
	11	.1910	C13133	C13227	2.313
	10	.1935	C13132	C13226	2.438
	9	.1960	C13131	C13225	2.438
	8	.1990	C13130	C13224	2.438
	7	.2010	C13129	C13223	2.438
13/64		.2031	C13110	C13185	2.438
	6	.2040	C13128	C13222	2.500
	5	.2055	C13127	C13221	2.500
	4	.2090	C13126	-	2.500
	3	.2130	C13125	C13220	2.500
7/32		.2188	C13111	C13186	2.500
	2	.2210	C13124	C13219	2.625
	1	.2280	C13123	C13218	2.625
15/64		.2344	C13112	C13187	2.625
1/4	E	.2500	C13113	C13188	2.750
	F	.2570	C13122	-	2.875
17/64		.2656	-	C13189	2.625
17/64		.2656	C13245	-	2.875
9/32		.2812	C13114	C13190	3.063
19/64		.2969	-	C13191	3.063
5/16		.3125	C13115	C13192	3.188
	O	.3160	-	C13211	3.438
21/64		.3281	-	C13193	3.438
11/32		.3438	C13116	C13194	3.438
23/64		.3594	-	C13195	3.500
3/8		.3750	C13117	C13196	3.625
25/64		.3906	-	C13197	3.750
13/32		.4062	C13118	C13198	3.750
27/64		.4219	-	C13199	3.938
7/16		.4375	C13119	C13200	4.063
29/64		.4531	-	C13201	4.188
15/32		.4688	C13120	C13202	4.313
31/64		.4844	-	C13203	4.375
1/2		.5000	C13121	C13204	4.500

Aircraft Extension

High Speed Steel

Material Reference	Steel (HRc)				Stainless Steel			Cast Iron (HRc)		Aluminum and Non-Ferrous	Hi-Temp Alloy		Hardened Steel (HRc)
	Low Carbon		Alloy		Austenitic	Martensitic	PH	Gray	Nodular		Ni, Co, Fe Based Super Alloy	Titanium	
	Hardness	13-38	>38	16-38	> 38	300 Series	400 series		18-22	22-32			>45
Bright	☆		☆		◆			◆		☆			

☆ = Best Performance ◆ = Acceptable

Note
Operating parameters: See Technical section



Aircraft Extension

Cobalt

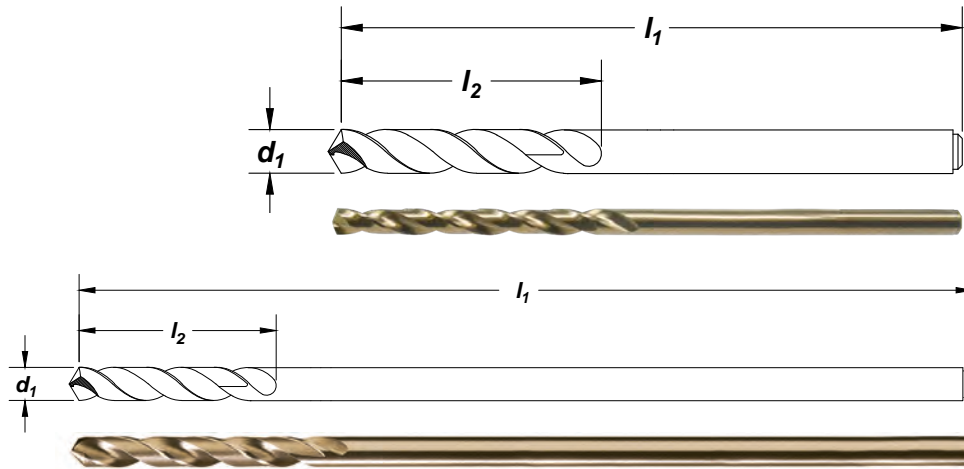

Feature:

Highly heat resistant substrate for tough to machine materials. Extended length for long reach applications.

drill diameter			order number		
fraction	wire/letter	decimal equiv.	3722-6	3722-12	flute length l ₂ (in)
			overall length		
d ₁			l ₁ (6.0 in)	l ₁ (12.0 in)	
	42	0.0935	C08100	—	1.250
3/32		0.0938	C08101	C08188	1.250
	41	0.0960	C08102	—	1.375
	40	0.0980	C08144	C08167	1.375
	39	0.0995	C08103	—	1.375
	38	0.1015	C08104	—	1.438
	37	0.1040	C08105	—	1.438
	36	0.1065	C08106	—	1.438
7/64		0.1094	C08107	C08168	1.500
	35	0.1100	C08108	—	1.500
	34	0.1110	C08109	—	1.500
	32	0.1160	C08110	—	1.625
	31	0.1200	C08111	—	1.625
1/8		0.1250	C08115	C08169	1.625
	30	0.1285	C08142	C08170	1.625
	29	0.1360	C08112	C08171	1.750
	28	0.1405	C08113	—	1.750
9/64		0.1406	C08114	C08172	1.750
	27	0.1440	C08140	C08173	1.875
	26	0.1470	C08145	—	1.875
	25	0.1495	C08146	—	1.875
	24	0.1520	C08147	—	2.000
	23	0.1540	C08148	—	2.000
5/32		0.1562	C08117	C08174	2.000
	22	0.1570	C08149	—	2.000
	21	0.1590	C08138	C08175	2.125
	20	0.1610	C08137	C08176	2.125
	19	0.1660	C08150	C08177	2.125
	18	0.1695	C08151	—	2.125
11/64		0.1719	C08152	C08178	2.125
	17	0.1730	C08153	—	2.188

continued on next page

Style: 3722-6, 3722-12 (continued)

drill diameter		decimal equiv.	order number		flute length
d_1	fraction		3722-6	3722-12	
fraction	wire/letter		overall length	overall length	l_2 (in)
			l_1 (6.0 in)	l_1 (12.0 in)	
	16	0.1770	C08135	C08179	2.188
	15	0.1800	C08154	—	2.188
	14	0.1820	C08155	—	2.188
	13	0.1850	C08134	—	2.313
3/16		0.1875	C08119	C08180	2.313
	12	0.1890	C08156	—	2.313
	11	0.1910	C08133	C08181	2.313
	10	0.1935	C08132	C08182	2.438
	9	0.1960	C08157	—	2.438
	8	0.1990	C08130	—	2.438
	7	0.2010	C08158	—	2.438
13/64		0.2031	C08159	C08183	2.438
	6	0.2040	C08160	—	2.500
	5	0.2055	C08161	—	2.500
	4	0.2090	C08162	—	2.500
	3	0.2130	C08163	—	2.500
7/32		0.2188	C08121	C08184	2.500
	2	0.2210	C08164	C08185	2.625
	1	0.2280	C08165	—	2.625
15/64		0.2344	C08166	C08186	2.625
1/4		0.2500	C08123	C08187	2.750

Aircraft Extension
Cobalt

Material Reference	Steel (HRc)				Stainless Steel			Cast Iron (HRc)		Aluminum and Non-Ferrous	Hi-Temp Alloy		Hardened Steel (HRc)
	Low Carbon		Alloy		Austenitic	Martensitic	PH	Gray	Nodular		Ni, Co, Fe Based Super Alloy	Titanium	
Hardness	13-38	>38	16-38	> 38	300 Series	400 series		18-22	22-32				>45
Straw	☆		☆		☆	☆	◆	◆	◆	☆	◆	◆	

☆ = Best Performance ◆ = Acceptable

Note

Operating parameters: See Technical section



Surface Treatment



Extra Length

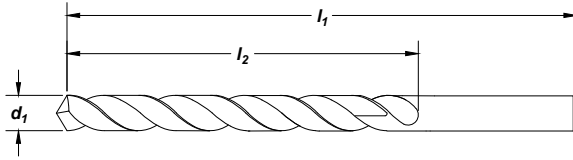

Feature:

Extra length for long reach and deeper drilling depth.

High Speed Steel

drill diameter d_1	decimal equiv.	overall length l_1 (in)	flute length l_2 (in)	order number 950E
3/32	.0938	8.000	5.500	C09655
7/64	.1094	8.000	5.500	C09656
1/8	.1250	8.000	5.500	C09657
1/8	.1250	10.000	7.500	C09707
1/8	.1250	12.000	9.000	C09736
9/64	.1406	8.000	5.500	C09658
5/32	.1562	8.000	5.500	C09659
5/32	.1562	10.000	7.500	C09709
5/32	.1562	12.000	9.000	C09738
11/64	.1719	8.000	5.500	C09660
3/16	.1875	8.000	5.500	C09661
3/16	.1875	10.000	7.500	C09711
3/16	.1875	12.000	9.000	C09740
13/64	.2031	8.000	5.500	C09662
7/32	.2188	8.000	5.500	C09663
7/32	.2188	10.000	7.500	C09713
7/32	.2188	12.000	9.000	C09742
15/64	.2344	8.000	5.500	C09664
15/64	.2344	10.000	7.500	C09714
1/4	.2500	8.000	5.500	C09665
1/4	.2500	10.000	7.500	C09715
1/4	.2500	12.000	9.000	C09744
17/64	.2656	8.000	5.500	C09666
9/32	.2812	8.000	5.500	C09667
9/32	.2812	10.000	7.500	C09717
9/32	.2812	12.000	9.000	C09746
19/64	.2969	8.000	5.500	C09668
5/16	.3125	8.000	5.500	C09669
5/16	.3125	10.000	7.500	C09719
5/16	.3125	12.000	9.000	C09748
21/64	.3281	8.000	5.500	C09670
11/32	.3438	8.000	5.500	C09671
11/32	.3438	10.000	7.500	C09721
11/32	.3438	12.000	9.000	C09750
23/64	.3594	8.000	5.500	C09672
3/8	.3750	8.000	5.500	C09673
3/8	.3750	10.000	7.500	C09723
3/8	.3750	12.000	9.000	C09752
25/64	.3906	8.000	5.500	C09674
13/32	.4062	8.000	5.500	C09675
13/32	.4062	10.000	7.500	C09725
13/32	.4062	12.000	9.000	C09754

continued on next page

drill diameter d₁	decimal equiv.	overall length l₁ (in)	flute length l₂ (in)	order number 950E
27/64	.4219	8.000	5.500	C09676
7/16	.4375	8.000	5.500	C09677
7/16	.4375	10.000	7.500	C09727
7/16	.4375	12.000	9.000	C09756
29/64	.4531	8.000	5.500	C09678
15/32	.4688	8.000	5.500	C09679
15/32	.4688	10.000	7.500	C09729
15/32	.4688	12.000	9.000	C09758
31/64	.4844	8.000	5.500	C09680
1/2	.5000	8.000	5.500	C09681
1/2	.5000	10.000	7.500	C09731
1/2	.5000	12.000	9.000	C09760
17/32	.5312	10.000	7.500	C09733
17/32	.5312	12.000	9.000	C09762
9/16	.5625	10.000	7.500	C09735
9/16	.5625	12.000	9.000	C09764
19/32	.5938	12.000	9.000	C09766
5/8	.6250	12.000	9.000	C09768
21/32	.6562	12.000	9.000	C09770
11/16	.6875	12.000	9.000	C09772
23/32	.7188	12.000	9.000	C09774
3/4	.7500	12.000	9.000	C09776

Extra Length
High Speed Steel

Material Reference	Steel (HRc)				Stainless Steel			Cast Iron (HRc)		Aluminum and Non-Ferrous	Hi-Temp Alloy		Hardened Steel (HRc)
	Low Carbon		Alloy		Austenitic	Martensitic	PH	Gray	Nodular		Ni, Co, Fe Based Super Alloy	Titanium	
Hardness	13-38	>38	16-38	> 38	300 Series	400 series		18-22	22-32				>45
Black Oxide	☆		☆					☆	◆				

☆ = Best Performance ◆ = Acceptable

Taper Shank

Standard, Undersized, & Oversized

Styles: 2410, 2411, 2412

Note

Undersized and oversized shank drills available from stock in popular sizes.

Operating parameters: See Technical section

Morse Taper Shank specs: See Technical section



Surface Treatment



Taper Shank

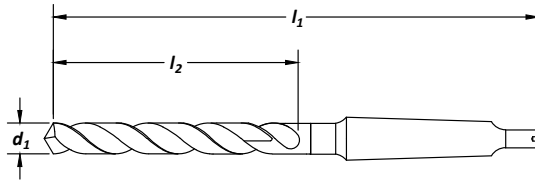

Feature:

General purpose use in steel and iron.

High Speed Steel

drill diameter d₁	decimal equiv.	overall length l₁ (in)	flute length l₂ (in)	morse taper	order number		
					2410 standard	2411 undersized	2412 oversized
1/8	.1250	5.125	1.875	1	C12040	—	—
5/32	.1562	5.375	2.125	1	C12052	—	—
3/16	.1875	5.750	2.500	1	C12064	—	—
13/64	.2031	6.000	2.750	1	C12069	—	—
7/32	.2188	6.000	2.750	1	C12075	—	—
15/64	.2344	6.125	2.875	1	C12082	—	—
1/4-E	.2500	6.125	2.875	1	C12091	—	—
17/64	.2656	6.250	3.000	1	C12099	—	—
9/32	.2812	6.250	3.000	1	C12113	—	—
19/64	.2969	6.375	3.125	1	C12117	—	—
5/16	.3125	6.375	3.125	1	C12124	—	—
21/64	.3281	6.500	3.250	1	C12132	—	—
11/32	.3438	6.500	3.250	1	C12139	—	—
23/64	.3594	6.750	3.500	1	C12147	—	—
3/8	.3750	6.750	3.500	1	C12154	—	—
25/64	.3906	7.000	3.625	1	C12162	—	—
13/32	.4062	7.000	3.625	1	C12167	—	—
27/64	.4219	7.250	3.875	1	C12170	—	—
7/16	.4375	7.250	3.875	1	C12173	—	—
29/64	.4531	7.500	4.125	1	C12176	—	—
15/32	.4688	7.500	4.125	1	C12178	—	—
31/64	.4844	8.250	4.375	2	C12181	—	—
1/2	.5000	8.250	4.375	2	C12183	—	—
1/2	.5000	7.750	4.375	1	—	C12483	—
33/64	.5156	8.500	4.625	2	C12186	—	—
17/32	.5312	8.500	4.625	2	C12188	—	—
35/64	.5469	8.750	4.875	2	C12191	—	—
9/16	.5625	8.750	4.875	2	C12194	—	—
37/64	.5781	8.750	4.875	2	C12196	—	—
19/32	.5938	8.750	4.875	2	C12199	—	—
39/64	.6094	8.750	4.875	2	C12201	—	—
5/8	.6250	8.750	4.875	2	C12204	—	—
41/64	.6406	9.000	5.125	2	C12207	—	—
21/32	.6562	9.000	5.125	2	C12209	—	—
43/64	.6719	9.250	5.375	2	C12212	—	—
11/16	.6875	9.250	5.375	2	C12214	—	—
11/16	.6875	10.000	5.375	3	—	—	C12670
45/64	.7031	9.500	5.625	2	C12216	—	—
23/32	.7188	9.500	5.625	2	C12218	—	—
47/64	.7344	9.750	5.875	2	C12220	—	—
3/4	.7500	9.750	5.875	2	C12222	—	—

continued on next page

drill diameter d₁	decimal equiv.	overall length l₁ (in)	flute length l₂ (in)	morse taper	order number		
					2410 standard	2411 undersized	2412 oversized
3/4	.7500	10.500	5.875	3	—	—	C12678
49/64	.7656	9.875	6.000	2	C12223	—	—
25/32	.7812	9.875	6.000	2	C12225	—	—
51/64	.7969	10.750	6.125	3	C12227	—	—
13/16	.8125	10.750	6.125	3	C12229	—	—
53/64	.8281	10.750	6.125	3	C12231	—	—
27/32	.8438	10.750	6.125	3	C12232	—	—
55/64	.8594	10.750	6.125	3	C12234	—	—
7/8	.8750	10.750	6.125	3	C12236	—	—
7/8	.8750	10.000	6.125	2	—	C12505	—
57/64	.8906	10.750	6.125	3	C12238	—	—
29/32	.9062	10.750	6.125	3	C12240	—	—
59/64	.9219	10.750	6.125	3	C12241	—	—
15/16	.9375	10.750	6.125	3	C12243	—	—
31/32	.9688	11.000	6.375	3	C12247	—	—
63/64	.9844	11.000	6.375	3	C12249	—	—
1	1.0000	11.000	6.375	3	C12250	—	—
1	1.0000	12.000	6.375	4	—	—	C12684
1-1/64	1.0156	11.125	6.500	3	C12252	—	—
1-1/32	1.0312	11.125	6.500	3	C12254	—	—
1-1/16	1.0625	11.250	6.625	3	C12257	—	—
1-1/16	1.0625	12.250	6.625	4	—	—	C12691
1-1/8	1.1250	12.750	7.125	4	C12265	—	—
1-1/8	1.1250	11.750	7.125	3	—	C12518	—
1-3/16	1.1875	13.000	7.375	4	C12272	—	—
1-1/4	1.2500	13.500	7.875	4	C12279	—	—
1-1/4	1.2500	12.500	7.875	3	—	C12532	—
1-5/16	1.3125	14.250	8.625	4	C12286	—	—
1-11/32	1.3438	14.375	8.750	4	C12290	—	—
1-3/8	1.3750	14.500	8.875	4	C12293	—	—
1-7/16	1.4375	14.750	9.125	4	C12301	—	—
1-15/32	1.4688	14.875	9.250	4	C12304	—	—
1-1/2	1.5000	15.000	9.375	4	C12308	—	—
1-17/32	1.5312	15.000	9.375	4	—	C12541	—
1-9/16	1.5625	16.625	9.625	5	C12315	—	—
1-5/8	1.6250	17.000	10.000	5	C12322	—	—
1-3/4	1.7500	17.125	10.125	5	C12336	—	—
1-3/4	1.7500	16.250	10.375	4	—	C12566	—
1-7/8	1.8750	17.375	10.375	5	C12351	—	—
2	2.0000	17.375	10.375	5	C12365	—	—

Taper Shank
High Speed Steel

Material Reference	Steel (HRc)				Stainless Steel			Cast Iron (HRc)		Aluminum and Non-Ferrous	Hi-Temp Alloy		Hardened Steel (HRc)
	Low Carbon		Alloy		Austenitic	Martensitic	PH	Gray	Nodular		Ni, Co, Fe Based Super Alloy	Titanium	
Hardness	13-38	>38	16-38	> 38	300 Series	400 series		18-22	22-32			>45	
Black Oxide	☆		☆					☆	◆				

☆ = Best Performance ◆ = Acceptable

Note
Operating parameters: See Technical section
Morse Taper Shank specs: See Technical section



Surface Treatment



Taper Shank

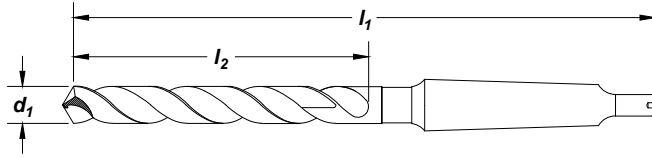

Feature:

Highly heat resistant substrate for tough to machine materials.

drill diameter d_1	decimal equiv.	overall length l_1 (in)	flute length l_2 (in)	morse taper	order number 2440
1/4	.2500	6.125	2.875	1	C12705
5/16	.3125	6.375	3.125	1	C12728
3/8	.3750	7.375	3.500	2	C12751
7/16	.4375	7.750	3.875	2	C12765
1/2	.5000	8.250	4.375	2	C12775
9/16	.5625	8.750	4.875	2	C12786
5/8	.6250	8.750	4.875	2	C12796
11/16	.6875	10.000	5.375	3	C12806
3/4	.7500	10.500	5.875	3	C12814
7/8	.8750	10.750	6.125	3	C12828
15/16	.9375	10.750	6.125	3	C12835
1	1.0000	11.000	6.375	3	C12842

Tech Tips

Morse Taper Shank Specifications

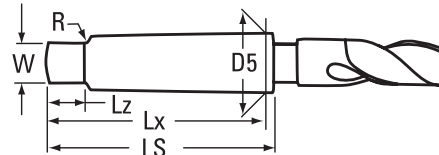

morse taper shank no.	taper per foot	taper per inch	D5 max shank dia.	LS length of shank	Lx length of shank to gauge line	Lz length of tang	W thickness of tang	R radius
1	.5985	.0498	.475	2.56	2.44	.37	.20	.19
2	.5994	.0499	.700	3.12	2.94	.44	.25	.25
3	.6023102	.0501	.938	3.87	3.69	.56	.31	.28
4	.6232	.0519	1.231	4.87	4.62	.62	.47	.31
5	.6315	.0526	1.749	6.12	5.87	.75	.62	.37
6	.6256	.0521	2.494	8.56	8.25	1.12	.75	.50

Material Reference	Steel (HRC)				Stainless Steel			Cast Iron (HRC)		Aluminum and Non-Ferrous	Hi-Temp Alloy		Hardened Steel (HRC)
	Low Carbon		Alloy		Austenitic	Martensitic	PH	Gray	Nodular		Ni, Co, Fe Based Super Alloy	Titanium	
Hardness	13-38	>38	16-38	> 38	300 Series	400 series			18-22	22-32			>45
Straw	☆		☆		☆	☆	◆		☆	☆			

☆ = Best Performance ◆ = Acceptable

Style: **940E**

Note

Operating parameters: See Technical section
Morse Taper Shank specs: See Technical section

ASME
B94.11M

HSS

118° K-Notch

Helix
High
35° to 45°

Taper
Shank

Surface
Treatment

Black
Oxide

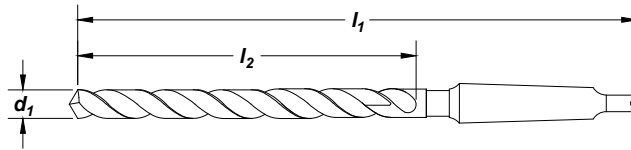

Taper Shank

Cobalt

Feature:

Extra length for long reach and deeper drilling depth.

drill diameter d_1	decimal equiv.	overall length l_1 (in)	flute length l_2 (in)	morse taper	order number 940E
31/64	.4844	11.875	8.000	2	C13830
1/2	.5000	11.875	8.000	2	C13831
33/64	.5156	11.875	8.000	2	C13832
17/32	.5312	11.875	8.000	2	C13833
35/64	.5469	11.875	8.000	2	C13834
9/16	.5625	11.875	8.000	2	C13835
37/64	.5781	11.875	8.000	2	C13836
19/32	.5938	11.875	8.000	2	C13837
5/8	.6250	11.875	8.000	2	C13839
41/64	.6406	11.875	8.000	2	C13840
21/32	.6562	11.875	8.000	2	C13841
43/64	.6719	11.875	8.000	2	C13842
11/16	.6875	11.875	8.000	2	C13843
45/64	.7031	11.875	8.000	2	C13844
23/32	.7188	11.875	8.000	2	C13845
3/4	.7500	11.875	8.000	2	C13847
49/64	.7656	11.875	8.000	2	C13848
25/32	.7812	11.875	8.000	2	C13849

Material Reference	Steel (HRC)		Stainless Steel			Cast Iron (HRC)		Aluminum and Non-Ferrous	Hi-Temp Alloy		Hardened Steel (HRC)
	Low Carbon	Alloy	Austenitic	Martensitic	PH	Gray	Nodular		Ni, Co, Fe Based Super Alloy	Titanium	
Hardness	13-38	>38	16-38	> 38	300 Series	400 series		18-22	22-32		>45
Black Oxide	☆		☆				☆	◆			

☆ = Best Performance ◆ = Acceptable

Note
Operating parameters: See Technical section

ASME
B94.11M

Carbide

Surface
Treatment

Bright

Countersink

Carbide

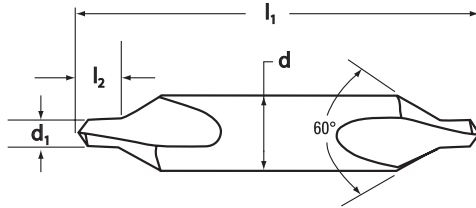

size number	drill diameter		body diameter	overall length	drill length	order number
	in	d ₁ decimal	d in	l ₁ in	l ₂ in	
#1	3/64	.0469	.125	1.500	.0469	C52772
#2	5/64	.0781	.188	2.000	.0781	C52773
#3	7/64	.1094	.250	2.000	.1094	C52774
#4	1/8	.1250	.313	2.125	.1250	C52775
#5	3/16	.1875	.438	2.750	.1875	C52776
#6	7/32	.2188	.500	3.000	.2188	C52777

Material Reference	Steel (HRC)				Stainless Steel			Cast Iron (HRC)		Aluminum and Non-Ferrous	Hi-Temp Alloy		Hardened Steel (HRC)
	Low Carbon		Alloy		Austenitic	Martensitic	PH	Gray	Nodular		Ni, Co, Fe Based Super Alloy	Titanium	
Hardness	13-38	>38	16-38	> 38	300 Series	400 series		18-22	22-32				>45
Bright	☆	◆	☆	◆	◆	◆		☆	☆	☆			

☆ = Best Performance ◆ = Acceptable

Bell Type Drill & Countersink

Style: **996**

Note
Bell-type tool forms protected centers.

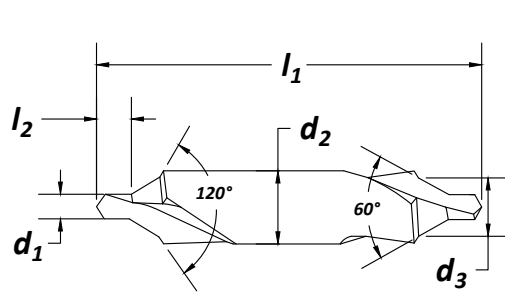

ASME B94.11M HSS 118° Surface Treatment Bright



size number	body diameter		drill diameter		bell diameter	overall length	drill length	order number
	d ₂ in	d ₁ in	d ₁ decimal	d ₃ in	l ₁ in	l ₂ in		
#11	.125	3/64	.0469	.100	1.250	.047	C46272	
#12	.188	1/16	.0625	.150	1.875	.063	C46273	
#13	.250	3/32	.0938	.200	2.000	.094	C46274	
#14	.313	7/64	.1094	.250	2.125	.109	C46275	
#15	.438	5/32	.1562	.350	2.750	.156	C46276	
#16	.500	3/16	.1875	.400	3.000	.188	C46277	
#17	.625	7/32	.2188	.500	3.250	.219	C46278	
#18	.750	1/4	.2500	.600	3.500	.250	C46279	

Countersink

High Speed Steel

Style: **998**

Plain Drill & Countersink

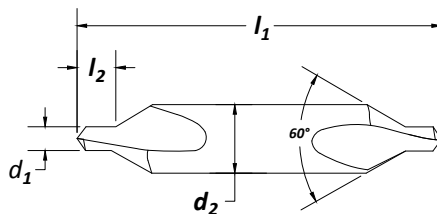

ASME B94.11M HSS 118° Surface Treatment Bright



size number	body diameter		drill diameter		overall length	drill length	order number
	d ₂ in	d ₁ in	d ₁ decimal	l ₁ in	l ₂ in		
#00	.125	.025	.0250	1.250	.030	C46261	
#0	.125	1/32	.0312	1.250	.038	C46262	
#1	.125	3/64	.0469	1.250	.047	C46263	
#2	.188	5/64	.0781	1.875	.078	C46264	
#3	.250	7/64	.1094	2.000	.109	C46265	
#4	.313	1/8	.1250	2.125	.125	C46266	
#5	.438	3/16	.1875	2.750	.188	C46267	
#6	.500	7/32	.2188	3.000	.219	C46268	
#7	.625	1/4	.2500	3.250	.250	C46269	
#8	.750	5/16	.3125	3.500	.313	C46270	

SET

Style: **998**

Plain Drill & Countersink

no. of pieces	size range	order number
5	#1 through #5	C00944



Material Reference	Steel (HRC)		Stainless Steel			Cast Iron (HRC)		Aluminum and Non-Ferrous	Hi-Temp Alloy		Hardened Steel (HRC)
	Low Carbon	Alloy	Austenitic	Martensitic	PH	Gray	Nodular		Ni, Co, Fe Based Super Alloy	Titanium	
	Hardness	13-38	>38	16-38	> 38	300 Series	400 series		18-22	22-32	
Bright	☆		☆					☆	☆	☆	

☆ = Best Performance ◆ = Acceptable

Countersink & Deburring

Style: **3001**



Note
All dimensions in inches.

Many tools are available with additional surface treatments. Please call for a quote.

Countersink and deburring tools are simple, all-purpose tools made of Cobalt that provide flawless countersinking and deburring. The chatter-free cutting action requires minimal power. The micro-smooth CNC precision ground construction produces clean, smooth cutting without smearing on a variety of materials. The tool especially excels in countersinking or deburring holes in aluminum, plastics and other nonmetallic.

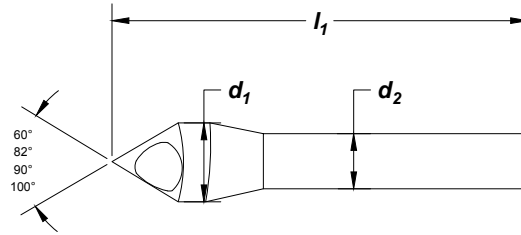

M42 Cobalt
Straight Shank

Surface Treatment

Bright



Additional View



Countersink

Cobalt

60° Countersink Angle

head diameter	diameter of cut		overall length l ₁ (in)	shank diameter d ₂ (in)	order no. 3001 bright
	d ₁	min max			
5/16	7/64	9/32	1-7/8	1/4	C94560
3/8	5/32	11/32	1-7/8	1/4	C94561
1/2	11/64	29/64	2	5/16	C94562
5/8	3/16	37/64	2-1/2	3/8	C94563
3/4	1/4	45/64	2-3/4	3/8	C94564
1	19/64	27/32	3	3/8	C94565
1-1/4	27/64	1-1/32	3-1/2	1/2	C94566

82° Countersink Angle

head diameter	diameter of cut		overall length l ₁ (in)	shank diameter d ₂ (in)	order no. 3001 bright
	d ₁	min max			
5/16	3/32	9/32	1-5/8	1/4	C94567
3/8	9/64	11/32	1-3/4	1/4	C94568
1/2	5/32	29/64	1-3/4	5/16	C94569
5/8	11/64	37/64	2-1/8	3/8	C94570
3/4	13/64	45/64	2-3/8	3/8	C94571
1	19/64	59/64	2-5/8	3/8	C94572
1-1/4	23/64	1-1/32	3-1/8	1/2	C94573

90° Countersink Angle

head diameter	diameter of cut		overall length l ₁ (in)	shank diameter d ₂ (in)	order no. 3001 bright
	d ₁	min max			
5/16	3/32	9/32	1-5/8	1/4	C94574
3/8	9/64	11/32	1-3/4	1/4	C94575
1/2	5/32	29/64	1-3/4	5/16	C94576
5/8	11/64	37/64	2-1/8	3/8	C94577
3/4	13/64	45/64	2-3/8	3/8	C94578
1	19/64	59/64	2-5/8	3/8	C94579
1-1/4	23/64	1-1/32	3-1/8	1/2	C94580

100° Countersink Angle

head diameter	diameter of cut		overall length l ₁ (in)	shank diameter d ₂ (in)	order no. 3001 bright
	d ₁	min max			
5/16	3/32	9/32	1-5/8	1/4	C94581
3/8	9/64	11/32	1-3/4	1/4	C94582
1/2	5/32	29/64	1-3/4	5/16	C94583
5/8	11/64	37/64	2-1/8	3/8	C94584
3/4	13/64	45/64	2-3/8	3/8	C94585
1	19/64	59/64	2-5/8	3/8	C94586
1-1/4	23/64	1-1/32	3-1/8	1/2	C94587

SET

Style: **3001** 4 Pieces

angle	sizes	order number 3001
60°	5/16, 3/8, 1/2, 5/8 C94560, C94561, C94562, C94563	C94588
82°	5/16, 3/8, 1/2, 5/8 C94567, C94568, C94569, C94570	C94589
90°	5/16, 3/8, 1/2, 5/8 C94574, C94575, C94576, C94577	C94590
100°	5/16, 3/8, 1/2, 5/8 C94581, C94582, C94583, C94584	C94591

SET

Style: **3001** 5 Pieces

angle	sizes	order number 3001
60°	5/16, 3/8, 1/2, 3/4, 1 C94560, C94561, C94562, C94564, C94565	C94592
82°	5/16, 3/8, 1/2, 3/4, 1 C94567, C94568, C94569, C94571, C94572	C94593
90°	5/16, 3/8, 1/2, 3/4, 1 C94574, C94575, C94576, C94578, C94579	C94594
100°	5/16, 3/8, 1/2, 3/4, 1 C94581, C94582, C94583, C94585, C94586	C94595

Material Reference	Steel (HRc)				Stainless Steel			Cast Iron (HRc)		Aluminum and Non-Ferrous	Hi-Temp Alloy		Hardened Steel (HRc)
	Low Carbon		Alloy		Austenitic	Martensitic	PH	Gray	Nodular		Ni, Co, Fe Based Super Alloy	Titanium	
Hardness	13-38	>38	16-38	> 38	300 Series	400 series		18-22	22-32				>45
Bright	☆		☆		◆					☆			

☆ = Best Performance ◆ = Acceptable

Style: **995**

Note
Operating parameters: See Technical section

ASME
B94.11M

HSS

118°

Straight
Shank

Surface
Treatment

Bright

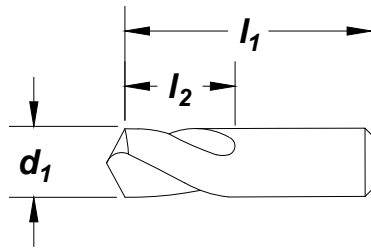

drill diameter d_1	decimal equiv.	overall length l_1 (in)	flute length l_2 (in)	order number
3/8	.3750	2.000	1.000	995 C11739
1/2	.5000	2.000	1.000	C11757
5/8	.6250	2.250	1.125	C11771
3/4	.7500	2.250	1.125	C11782
1	1.0000	2.500	1.250	C11796

Spotting / Centering / Drill
High Speed Steel

TECH TIP

Using Spotting and Centering Drills

- Use these drills to get true and accurate centers.
- There is no body clearance on these drills to allow chucking close to the point. This features helps to maintain drill accuracy for centering.

TECH TIP

Point Angle: 90° versus 120°

- Use the 90° point spotting drill for a 118° point following drill.
- Use the 120° point spotting drill for a 135° following drill.

NEW

Style: **1799**

Spotting & Centering
Long

Note
Operating parameters: See Technical section

ASME
B94.11M

Carbide

Straight
Shank

Surface
Treatment

AlTiN

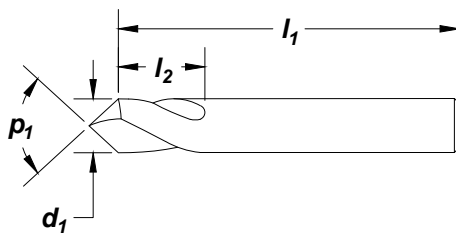

drill diameter d_1	decimal equiv.	overall length l_1 (in)	flute length l_2 (in)	order number		
				p_1 -point angle		
				90°	120°	142°
1/8	0.1250	2	3/8	C46400	C46401	C46402
3/16	0.1875	3	3/4	C46403	C46404	C46405
1/4	0.2500	3	3/4	C46406	C46407	C46408
5/16	0.3125	2 1/2	1	C46409	C46410	C46411
3/8	0.3750	3	1	C46412	C46413	C46414
1/2	0.5000	4	1	C46415	C46416	C46417

Material Reference	Steel (HRc)				Stainless Steel			Cast Iron (HRc)		Aluminum and Non-Ferrous	Hi-Temp Alloy		Hardened Steel (HRc)
	Low Carbon		Alloy		Austenitic	Martensitic	PH	Gray	Nodular		Ni, Co, Fe Based Super Alloy	Titanium	
	Hardness	13-38	>38	16-38	> 38	300 Series	400 series		18-22	22-32			>45
AlTiN	☆		☆					☆	☆	◆			

☆ = Best Performance ◆ = Acceptable

NC Spotting & Centering

Short

Style: 2636

High Speed Steel Spotting / Centering / Drift

Note
Operating parameters: See Technical section

ASME
B94.11M

M42
Cobalt



Surface
Treatment

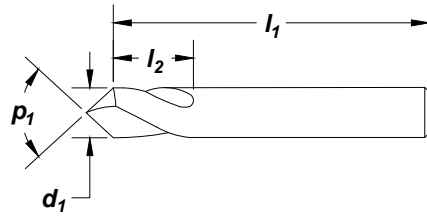

drill diameter d_1	decimal equiv.	overall length l_1 (in)	flute length l_2 (in)	order number p_1 - point angle	
				90°	120°
1/4	.2500	2.500	1.000	C26167	C26174
3/8	.3750	3.125	1.125	C26168	C26175
1/2	.5000	3.750	1.500	C26169	C26176
5/8	.6250	4.250	1.625	C26170	C26177
3/4	.7500	5.000	1.750	C26171	C26178
1	1.0000	6.000	1.750	C26172	C26179

NC Spotting & Centering

Long

Style: 2646

ASME
B94.11M

M42
Cobalt



Surface
Treatment

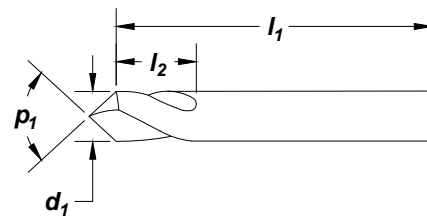

drill diameter d_1	decimal equiv.	overall length l_1 (in)	flute length l_2 (in)	order number p_1 - point angle	
				90°	120°
1/4	.2500	4.000	1.000	C26181	C26188
3/8	.3750	5.000	1.125	C26182	C26189
1/2	.5000	6.000	1.500	C26183	C26190
5/8	.6250	7.125	1.625	C26184	C26191
3/4	.7500	8.000	1.750	C26185	C26192
1	1.0000	8.000	1.750	C26186	C26193

NC Spotting & Centering

Short and Long

SET

Style: 2636, 2646

no. of pieces	point angle	size range	order number	
			2636	2646
6	90°	1/4" through 1"	C26173	C26187
6	120°	1/4" through 1"	C26180	C26194



6-Piece Set
#C26173

Material Reference	Steel (HRC)				Stainless Steel			Cast Iron (HRc)		Aluminum and Non-Ferrous	Hi-Temp Alloy		Hardened Steel (HRc)
	Low Carbon		Alloy		Austenitic	Martensitic	PH	Gray	Nodular		Ni, Co, Fe Based Super Alloy	Titanium	
	Hardness	13-38	>38	16-38	> 38	300 Series	400 series		18-22	22-32			>45
Straw	☆		☆		☆			☆	☆	☆	◆		

☆ = Best Performance ◆ = Acceptable

Style: **2635**

Note
Operating parameters: See Technical section

HSS
90°
120°
Straight Shank
Surface Treatment
Bright

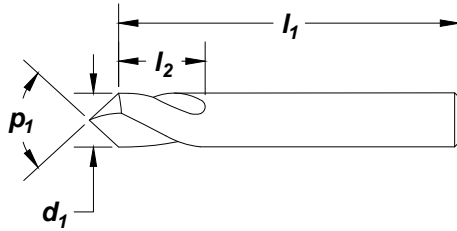

drill diameter d_1	decimal equiv.	overall length l_1 (in)	flute length l_2 (in)	order number p_1 - point angle	
				90°	120°
1/4	.2500	2.500	1.000	C24167	C24174
3/8	.3750	3.125	1.125	C24168	C24175
1/2	.5000	3.750	1.500	C24169	C24176
5/8	.6250	4.250	1.625	C24170	C24177
3/4	.7500	5.000	1.750	C24171	C24178
1	1.0000	6.000	1.750	C24172	C24179

Spotting / Centering / Drift High Speed Steel

Style: **2645**

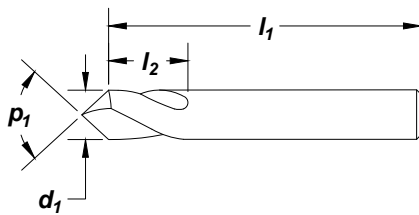

drill diameter d_1	decimal equiv.	overall length l_1 (in)	flute length l_2 (in)	order number p_1 - point angle	
				90°	120°
1/4	.2500	4.000	1.000	C24181	C24188
3/8	.3750	5.000	1.125	C24182	C24189
1/2	.5000	6.000	1.500	C24183	C24190
5/8	.6250	7.125	1.625	C24184	C24191
3/4	.7500	8.000	1.750	C24185	C24192
1	1.0000	8.000	1.750	C24186	C24193

SET

Style: **2635, 2645**

no. of pieces	point angle	size range	order number	
			2635	2645
6	90°	1/4" through 1"	C24173	C24187
6	120°	1/4" through 1"	C24180	C24194



6-Piece Set #C24187

Material Reference	Steel (HRC)				Stainless Steel			Cast Iron (HRC)		Aluminum and Non-Ferrous	Hi-Temp Alloy		Hardened Steel (HRC)
	Low Carbon		Alloy		Austenitic	Martensitic	PH	Gray	Nodular		Ni, Co, Fe Based Super Alloy	Titanium	
	Hardness	13-38	>38	16-38	> 38	300 Series	400 series		18-22	22-32			>45
Bright	☆		☆		◆			☆	☆	☆			

☆ = Best Performance ◆ = Acceptable

Single Flute Carbide Countersink

Style: **110C1**

Carbide

Surface Treatment

Bright

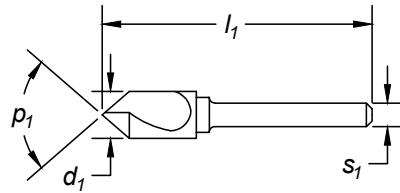

tool diameter
 d_1 (in)

shank diameter
 s_1 (in)

overall length
 l_1 (in)

p_1 order number - **110C1**

fraction	decimal	s_1 (in)	l_1 (in)	p_1 order number - 110C1		
				60° angle	82° angle	90° angle
1/8	.1250	1/8	1-1/2	C46320	C46328	C46336
3/16	.1875	3/16	2	C46321	C46329	C46337
1/4	.2500	1/4	2	C46322	C46330	C46338
3/8	.3750	1/4	2-5/8	C46323	C46331	C46339
1/2	.5000	1/4	2-7/8	C46324	C46332	C46340
5/8	.6250	3/8	3	C46325	C46333	C46341
3/4	.7500	1/2	3	C46326	C46334	C46342
1	1.000	1/2	2-3/4	C46327	C46335	C46343

3 Flute Carbide Countersink

Style: **110C3**

Carbide

Surface Treatment

Bright

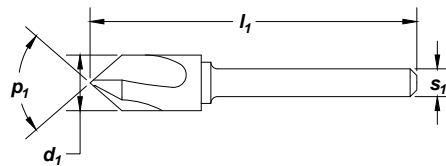

tool diameter
 d_1 (in)

shank diameter
 s_1 (in)

overall length
 l_1 (in)

p_1 order number - **110C3**

fraction	decimal	s_1 (in)	l_1 (in)	p_1 order number - 110C3		
				60° angle	82° angle	90° angle
1/8	.1250	1/8	1-1/2	C46344	C46352	C46360
3/16	.1875	3/16	2	C46345	C46353	C46361
1/4	.2500	1/4	2	C46346	C46354	C46362
3/8	.3750	1/4	2-5/8	C46347	C46355	C46363
1/2	.5000	1/4	2-7/8	C46348	C46356	C46364
5/8	.6250	3/8	3	C46349	C46357	C46365
3/4	.7500	1/2	3	C46350	C46358	C46366
1	1.000	1/2	2-3/4	C46351	C46359	C46367

6 Flute Carbide Countersink

Style: **110C6**

Carbide

Surface Treatment

Bright

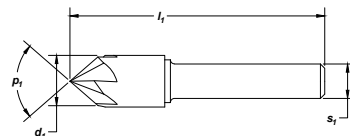

tool diameter
 d_1 (in)

shank diameter
 s_1 (in)

overall length
 l_1 (in)

p_1 order number - **110C6**

fraction	decimal	s_1 (in)	l_1 (in)	p_1 order number - 110C6		
				60° angle	82° angle	90° angle
1/8	.1250	1/8	1-1/2	C46368	C46376	C46384
3/16	.1875	3/16	2	C46369	C46377	C46385
1/4	.2500	1/4	2	C46370	C46378	C46386
3/8	.3750	1/4	2-5/8	C46371	C46379	C46387
1/2	.5000	1/4	2-7/8	C46372	C46380	C46388
5/8	.6250	3/8	3	C46373	C46381	C46389
3/4	.7500	1/2	3	C46374	C46382	C46390
1	1.000	1/2	2-3/4	C46375	C46383	C46391

Material Reference	Steel (HRC)				Stainless Steel			Cast Iron (HRC)		Aluminum and Non-Ferrous	Hi-Temp Alloy		Hardened Steel (HRC)
	Low Carbon		Alloy		Austenitic	Martensitic	PH	Gray	Nodular		Ni, Co, Fe Based Super Alloy	Titanium	
	Hardness	13-38	>38	16-38	> 38	300 Series	400 series		18-22	22-32			>45
Bright	★		☆					☆	☆				

☆ = Best Performance ★ = Acceptable

Style: 10001

Single Flute Countersink

Note
Operating parameters:
See Technical section

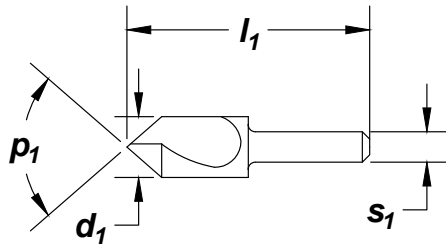

HSS **Surface Treatment**



Countersink

High Speed Steel

tool diameter d ₁ (in)		shank diameter		overall length		p ₁ order number - 10001				
fraction	decimal	s ₁ (in)	l ₁ (in)	60° angle	82° angle	90° angle	100° angle	120° angle		
1/4	.2500	.188	1.500	C46101	C46102	C46103	C46104	C46106		
3/8	.3750	.250	1.750	C46107	C46108	C46109	C46110	C46112		
1/2	.5000	.250	2.000	C46113	C46114	C46115	C46116	C46118		
5/8	.6250	.375	2.250	C46119	C46120	C46121	C46122	C46123		
3/4	.7500	.500	2.625	C46124	C46125	C46126	C46127	C46129		
1	1.0000	.500	2.750	C46130	C46131	C46132	C46133	C46135		
1-1/4	1.2500	.500	2.750	C46136	C46137	C46138	-	-		
1-1/2	1.5000	.750	2.875	C46141	C46139	C46140	-	-		
2	2.0000	.750	3.250	C46142	-	C46143	-	-		

Style: 10003

3 Flute Countersink

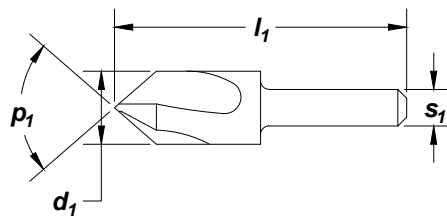

HSS **Surface Treatment**



tool diameter d ₁		shank diameter		overall length		p ₁ order number - 10003				
fraction	decimal	s ₁ (in)	l ₁ (in)	60° angle	82° angle	90° angle	100° angle	120° angle		
1/4	.2500	.188	1.500	C46150	C46151	C46152	C46153	C46155		
3/8	.3750	.250	1.750	C46156	C46157	C46158	C46159	C46161		
1/2	.5000	.250	2.000	C46162	C46163	C46164	C46165	C46167		
5/8	.6250	.375	2.250	C46168	C46169	C46170	C46171	C46173		
3/4	.7500	.500	2.625	C46174	C46175	C46176	C46177	C46179		
1	1.0000	.500	2.750	C46180	C46181	C46182	C46183	C46185		
1-1/4	1.2500	.500	2.750	C46186	C46187	C46188	-	-		
1-1/2	1.5000	.750	2.875	C46189	C46190	C46191	-	-		
2	2.0000	.750	3.250	-	-	C46192	-	-		

SET

Style: 10001, 10003

Countersink Sets Single flute and 3 flute



no. of pieces	angle	size range	order number	
			10001	10003
5	60°	1/4" through 3/4" x 1/8"	C00970	C00972
5	82°	1/4" through 3/4" x 1/8"	C00971	C00973

Material Reference	Steel (HRc)				Stainless Steel			Cast Iron (HRc)		Aluminum and Non-Ferrous	Hi-Temp Alloy		Hardened Steel (HRc)
	Low Carbon		Alloy		Austenitic	Martensitic	PH	Gray	Nodular		Ni, Co, Fe Based Super Alloy	Titanium	
Hardness	13-38	>38	16-38	> 38	300 Series	400 series		18-22	22-32			>45	
Black Oxide	☆		◆					☆	☆				

☆ = Best Performance ◆ = Acceptable

4 Flute Center Reamer / Countersink

Style: **610**

Surface Treatment



Countersink

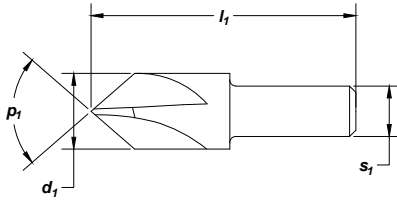

High Speed Steel

tool diameter d_1 (in)		shank diameter s_1 (in)	overall length l_1 (in)	p_1 order number - 610			
fraction	decimal			60° angle	82° angle	90° angle	100° angle
1/4	.2500	.188	1.500	C46198	C46199	C46200	C46201
3/8	.3750	.250	1.750	C46204	C46205	C46206	C46207
1/2	.5000	.375	2.000	C46210	C46211	C46212	C46213
5/8	.6250	.375	2.250	C46216	C46217	C46218	C46219
3/4	.7500	.500	2.625	C46222	C46223	C46224	C46225

4 Flute Center Reamer / Countersink

SET

Style: **610**

no. of pieces	angle	size range	order number
5	82°	1/4" - 3/4" x 1/8"	610 C00969



Drift Drill

Style: **105**

fits morse taper socket or sleeve	order number
	105
#1	C53665
#2	C53666
#3	C53667
#4	C53668

Surface Treatment



TECH TIPS

Using Drill Drifts

- Used to remove taper shank drills and tapered sockets from the spindle or from holders.

Note
Operating parameters: See Technical section

ANSI SIZES Carbide Thru Holes Straight Flute Straight Shank Surface Treatment Bright

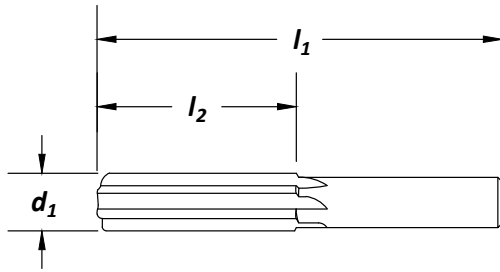

Reamers

Carbide

Feature:

High red hardness for extended wear life in high heat conditions.

reamer dia. d₁	decimal equiv.	shank dia.	overall length l₁ (in)	flute length l₂ (in)	number of flutes	order number 1730
1/16	.0625	.058	1.500	.375	4	C50103
3/32	.0938	.088	2.000	.500	4	C50121
1/8	.1250	.120	2.250	.625	4	C50133
5/32	.1562	.151	2.500	.750	4	C50145
3/16	.1875	.182	2.750	.875	4	C50157
7/32	.2188	.213	3.000	1.000	4	C50168
1/4	.2500	.244	3.000	1.000	4	C50180
9/32	.2812	.270	3.250	1.125	6	C50194
5/16	.3125	.301	3.250	1.125	6	C50203
11/32	.3438	.332	3.500	1.250	6	C50214
3/8	.3750	.363	3.500	1.250	6	C50226

TECH TIPS

How to Select the Correct Reamer Style

- Straight flute reamers, styles 4001, 4005, 1730, and 4703, are for use in through hole applications.
- Spiral flute reamers, style 4030, are for use in blind holes. They produce a smoother finish than straight flute reamers.
- Use reamer style 616, bridge reamer and style 618, car reamer, for aligning misaligned holes.
- Style 642 taper pipe reamers are used to ream a tapered hole before tapping only in soft, stringy materials.
- High spiral Taper Pin Reamers, style 650 are used to produce taper pin holes; the high spiral prevents chip packing.
- Taper pin reamers styles 657 and 659 are used to produce taper pin holes primarily by hand reaming; drill the starting hole a few thousands of an inch smaller than the desired small diameter of the finished hole.

Material Reference	Steel (HRc)				Stainless Steel			Cast Iron (HRc)		Aluminum and Non-Ferrous	Hi-Temp Alloy		Hardened Steel (HRc)
	Low Carbon		Alloy		Austenitic	Martensitic	PH	Gray	Nodular		Ni, Co, Fe Based Super Alloy	Titanium	
Hardness	13-38	>38	16-38	> 38	300 Series	400 series		18-22	22-32				>45
Bright	☆	◆	☆	◆	☆	☆		☆	☆	☆			

☆ = Best Performance ◆ = Acceptable

Note
Custom reamer dimensions shown in Technical Section.

Operating parameters:
See Technical section

ASME
B94.2

DIN
338

HSS



Surface
Treatment



Reamers

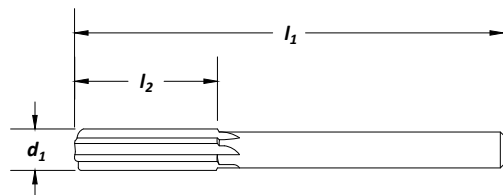

High Speed Steel

reamer dia.		overall length		flute length		number of flutes	order number
in	d ₁ wire	decimal equiv.	l ₁ in	l ₂ in	mm		
	60	.0400	2.500	.500		4	4001 C25003
	59	.0410	2.500	.500		4	C25005
	58	.0420	2.500	.500		4	C25008
	57	.0430	2.500	.500		4	C25010
	56	.0465	2.500	.500		4	C25019
3/64		.0469	2.500	.500		4	C25020
	55	.0520	2.500	.500		4	C25034
	54	.0550	2.500	.500		4	C25041
		1.5	.0591	63.50	12.70	4	C25059
	53	.0595	2.500	.500		4	C25053
1/16		.0625	2.500	.500		4	C25060
	52	.0635	2.500	.500		4	C25063
	51	.0670	3.000	.750		4	C25072
	50	.0700	3.000	.750		4	C25079
	49	.0730	3.000	.750		4	C25087
	48	.0760	3.000	.750		4	C25094
5/64		.0781	3.000	.750		4	C25100
	47	.0785	3.000	.750		4	C25101
		2.0	.0787	76.20	19.05	4	C25095
	46	.0810	3.000	.750		4	C25108
	45	.0820	3.000	.750		4	C25110
	44	.0860	3.000	.750		4	C25120
	43	.0890	3.000	.750		4	C25128
	42	.0935	3.000	.750		4	C25139
3/32		.0938	3.000	.750		4	C25140
	41	.0960	3.500	.875		4	C25146
	40	.0980	3.500	.875		4	C25151
	39	.0995	3.500	.875		4	C25155
	38	.1015	3.500	.875		4	C25159
	37	.1040	3.500	.875		4	C25165
	36	.1065	3.500	.875		4	C25171
7/64		.1094	3.500	.875		4	C25178
	35	.1100	3.500	.875		4	C25180
	34	.1110	3.500	.875		4	C25183
	33	.1130	3.500	.875		4	C25187
	32	.1160	3.500	.875		4	C25194
		3.0	.1181	88.90	22.23	4	C25185
	31	.1200	3.500	.875		6	C25203
1230*		.1230	3.500	.875		6	*C25210
.1240		.1240	3.500	.875		6	C25212
.1247*		.1247	3.500	.875		6	*C25215
1/8		.1250	3.500	.875		6	C25216
.1260		.1260	3.500	.875		6	C25220
	30	.1285	3.500	.875		6	C25226
	29	.1360	4.000	1.000		6	C25243

*dowel pin reamer tolerance +.0000/- .0002

continued on next page

Styles: 4001 (continued)

reamer dia.			overall length		flute length		number of flutes	order number
in	d ₁ wire	metric	decimal equiv.	l ₁ in	l ₁ mm	l ₂ in		
	28		.1405	4.000		1.000		C25253
9/64			.1406	4.000		1.000		C25254
	27		.1440	4.000		1.000		C25262
	26		.1470	4.000		1.000		C25269
	25		.1495	4.000		1.000		C25275
	24		.1520	4.000		1.000		C25281
	23		.1540	4.000		1.000		C25285
5/32			.1562	4.000		1.000		C25290
	22		.1570	4.000		1.000		C25292
		4.0	.1575		101.60		25.40	C25291
	21		.1590	4.500		1.125		C25297
	20		.1610	4.500		1.125		C25301
	19		.1660	4.500		1.125		C25313
	18		.1695	4.500		1.125		C25322
11/64			.1719	4.500		1.125		C25327
	17		.1730	4.500		1.125		C25330
	16		.1770	4.500		1.125		C25339
	15		.1800	4.500		1.125		C25346
	14		.1820	4.500		1.125		C25351
	13		.1850	4.500		1.125		C25357
1855*			.1855	4.500		1.125		*C25360
.1865			.1865	4.500		1.125		C25362
.1870*			.1870	4.500		1.125		*C25365
3/16			.1875	4.500		1.125		C25366
.1885			.1885	4.500		1.125		C25368
	12		.1890	4.500		1.125		C25369
	11		.1910	5.000		1.250		C25374
	10		.1935	5.000		1.250		C25380
	9		.1960	5.000		1.250		C25385
		5.0	.1969		127.00		31.75	C25314
	8		.1990	5.000		1.250		C25392
	7		.2010	5.000		1.250		C25397
13/64			.2031	5.000		1.250		C25402
	6		.2040	5.000		1.250		C25404
	5		.2055	5.000		1.250		C25408
	4		.2090	5.000		1.250		C25417
	3		.2130	5.000		1.250		C25426
7/32			.2188	5.000		1.250		C25438
	2		.2210	6.000		1.500		C25443
	1		.2280	6.000		1.500		C25459
	A		.2340	6.000		1.500		C25473
15/64			.2344	6.000		1.500		C25474
		6.0	.2362		152.40		38.10	C25475
	B		.2380	6.000		1.500		C25483
	C		.2420	6.000		1.500		C25492
	D		.2460	6.000		1.500		C25501
2480*			.2480	6.000		1.500		*C25508
.2490			.2490	6.000		1.500		C25510
.2495*			.2495	6.000		1.500		*C25512

*dowel pin reamer tolerance +.0000/-.0002

continued on next page

Material Reference	Steel (HRc)				Stainless Steel			Cast Iron (HRc)		Aluminum and Non-Ferrous	Hi-Temp Alloy		Hardened Steel (HRc)
	Low Carbon		Alloy		Austenitic	Martensitic	PH	Gray	Nodular		Ni, Co, Fe Based Super Alloy	Titanium	
	Hardness	13-38	>38	16-38	> 38	300 Series	400 series		18-22	22-32			>45
Bright	☆		☆		☆			☆	◆	☆			

☆ = Best Performance ◆ = Acceptable

Reamers

High Speed Steel

Reamers
High Speed Steel

reamer dia.		decimal		overall length		flute length		number of flutes	order number
in	d ₁ wire	metric	equiv.	l ₁ in	mm	l ₂ in	mm		
1/4	E		.2500	6.000		1.500		6	C25513
.2510			.2510	6.000		1.500		6	C25516
	F		.2570	6.000		1.500		6	C25530
	G		.2610	6.000		1.500		6	C25539
17/64			.2656	6.000		1.500		6	C25550
	H		.2660	6.000		1.500		6	C25552
	I		.2720	6.000		1.500		6	C25566
		7.0	.2756		152.40		38.10	6	C25567
	J		.2770	6.000		1.500		6	C25577
	K		.2810	6.000		1.500		6	C25585
9/32			.2812	6.000		1.500		6	C25608
	L		.2900	6.000		1.500		6	C25605
	M		.2950	6.000		1.500		6	C25617
19/64			.2969	6.000		1.500		6	C25622
	N		.3020	6.000		1.500		6	C25634
.3105*			.3105	6.000		1.500		6	*C25655
.3115			.3115	6.000		1.500		6	C25658
.3120*			.3120	6.000		1.500		6	*C25660
5/16			.3125	6.000		1.500		6	C25661
.3135			.3135	6.000		1.500		6	C25663
		8.0	.3150		152.40		38.10	6	C25668
	O		.3160	6.000		1.500		6	C25669
	P		.3230	6.000		1.500		6	C25685
21/64			.3281	6.000		1.500		6	C25698
	Q		.3320	6.000		1.500		6	C25707
	R		.3390	6.000		1.500		6	C25723
11/32			.3438	6.000		1.500		6	C25733
	S		.3480	7.000		1.750		6	C25742
		9.0	.3543		177.80		44.45	6	C25743
	T		.3580	7.000		1.750		6	C25764
23/64			.3594	7.000		1.750		6	C25768
	U		.3680	7.000		1.750		6	C25789
.3730*			.3730	7.000		1.750		6	*C25801
.3740			.3740	7.000		1.750		6	C25804
.3745*			.3745	7.000		1.750		6	*C25806
3/8			.3750	7.000		1.750		6	C25807
.3760			.3760	7.000		1.750		6	C25809
	V		.3770	7.000		1.750		6	C25811
	W		.3860	7.000		1.750		6	C25833
25/64			.3906	7.000		1.750		6	C25844
		10.0	.3937		177.80		44.45	6	C25845
	X		.3970	7.000		1.750		6	C25858
	Y		.4040	7.000		1.750		6	C25873
13/32			.4062	7.000		1.750		6	C25878
	Z		.4130	7.000		1.750		6	C25892
27/64			.4219	7.000		1.750		6	C25911
		11.0	.4331		177.80		44.45	6	C25912
.4355*			.4355	7.000		1.750		6	*C25942
.4365			.4365	7.000		1.750		6	C25944
.4370*			.4370	7.000		1.750		6	*C25946
7/16			.4375	7.000		1.750		6	C25947
.4385			.4385	7.000		1.750		6	C25949
29/64			.4531	7.000		1.750		6	C25981
15/32			.4688	7.000		1.750		6	C26014
		12.0	.4724		203.20		50.80	6	C26015
31/64			.4844	8.000		2.000		6	C26048
.4990*			.4990	8.000		2.000		6	*C26080

*dowel pin reamer tolerance +.0000/-0.0002

continued on next page

Styles: 4001 (continued)

reamer dia.			overall length		flute length		number of flutes	order number	
in	d ₁ wire	metric	decimal equiv.	in	mm	in			mm
1/2			.5000	8.000		2.000		6	C26083
.5010*			.5010	8.000		2.000		8	*C26085
		13.0	.5118		203.20		50.80	8	C26086
17/32			.5312	8.000		2.000		8	C26150
		14.0	.5512		203.20		50.80	8	C26151
9/16			.5625	8.000		2.000		8	C26217
		15.0	.5906		203.20		50.80	8	C26218
19/32			.5938	8.000		2.000		8	C26284
5/8			.6250	9.000		2.250		8	C26351
		16.0	.6299		228.60		57.15	8	C26352
21/32			.6562	9.000		2.250		8	C26418
11/16			.6875	9.000		2.250		8	C26485
23/32			.7188	9.000		2.250		8	C26550
3/4			.7500	9.500		2.500		8	C26615
25/32			.7812	9.500		2.500		8	C26680
13/16			.8125	9.500		2.500		8	C26746
27/32			.8438	9.500		2.500		8	C26811
7/8			.8750	10.000		2.625		8	C26876
29/32			.9062	10.000		2.625		8	C26941
15/16			.9375	10.000		2.625		8	C27006
31/32			.9688	10.000		2.625		8	C27072
1			1.0000	10.500		2.750		8	C27137
1-1/16			1.0625	10.500		2.750		10	C27144
1-1/8			1.1250	11.000		2.875		10	C27152
1-3/16			1.1875	11.000		2.875		10	C27159
1-1/4			1.2500	11.500		3.000		10	C27166
1-3/8			1.3750	12.000		3.250		10	C27180
1-1/2			1.5000	12.500		3.500		12	C27195

*dowel pin reamer tolerance +.0000/--.0002

Reamers

High Speed Steel

SET

Style: 4001

Straight Shank and Flute Chucking

no. of pieces	surface treatment	size range	order number
29	bright	1/16" through 1/2" x 1/64"	C00964



Material Reference	Steel (HRC)				Stainless Steel			Cast Iron (HRC)		Aluminum and Non-Ferrous	Hi-Temp Alloy		Hardened Steel (HRC)
	Low Carbon		Alloy		Austenitic	Martensitic	PH	Gray	Nodular		Ni, Co, Fe Based Super Alloy	Titanium	
	Hardness	13-38	>38	16-38	> 38	300 Series	400 series		18-22	22-32			>45
Bright	☆		☆		☆			☆	◆	☆			

☆ = Best Performance ◆ = Acceptable

Note

Custom reamer dimensions shown in Technical Section.

Operating parameters:
See Technical section

ASME B94.2 HSS Blind Holes Thru Holes RH Spiral Flute Straight Shank

Surface Treatment

Bright

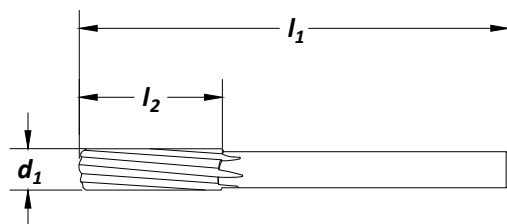

Reamers

High Speed Steel

reamer dia. d₁	decimal equiv.	overall length l₁ (in)	flute length l₂ (in)	number of flutes	order number 4030
1/16	.0625	2.500	.500	4	C29273
5/64	.0781	3.000	.750	4	C29311
3/32	.0938	3.000	.750	4	C29350
7/64	.1094	3.500	.875	4	C29386
1/8	.1250	3.500	.875	6	C29421
9/64	.1406	4.000	1.000	6	C29457
5/32	.1562	4.000	1.000	6	C29493
3/16	.1875	4.500	1.125	6	C29565
13/64	.2031	5.000	1.250	6	C29601
7/32	.2188	5.000	1.250	6	C29637
1/4	.2500	6.000	1.500	6	C29709
17/64	.2656	6.000	1.500	6	C29745
9/32	.2812	6.000	1.500	6	C29803
5/16	.3125	6.000	1.500	6	C29853
21/64	.3281	6.000	1.500	6	C29890
11/32	.3438	6.000	1.500	6	C29925
23/64	.3594	7.000	1.750	6	C29960
3/8	.3750	7.000	1.750	6	C29997
25/64	.3906	7.000	1.750	6	C30033
13/32	.4062	7.000	1.750	6	C30067
7/16	.4375	7.000	1.750	6	C30134
29/64	.4531	7.000	1.750	6	C30168
15/32	.4688	7.000	1.750	6	C30201
31/64	.4844	8.000	2.000	6	C30235
1/2	.5000	8.000	2.000	6	C30268
17/32	.5312	8.000	2.000	8	C30335
9/16	.5625	8.000	2.000	8	C30402
19/32	.5938	8.000	2.000	8	C30469
5/8	.6250	9.000	2.250	8	C30536
21/32	.6562	9.000	2.250	8	C30603
11/16	.6875	9.000	2.250	8	C30670
23/32	.7188	9.000	2.250	8	C30735
3/4	.7500	9.500	2.500	8	C30800
25/32	.7812	9.500	2.500	8	C30865
13/16	.8125	9.500	2.500	8	C30931
7/8	.8750	10.000	2.625	8	C31061
15/16	.9375	10.000	2.625	8	C31191
1	1.0000	10.500	2.750	8	C31322
1-1/8	1.1250	11.000	2.875	10	C31337
1-1/4	1.2500	11.500	3.000	10	C31351
1-3/8	1.3750	12.000	3.250	10	C31365
1-1/2	1.5000	12.500	3.500	12	C31380

Material Reference	Steel (HRc)				Stainless Steel			Cast Iron (HRc)		Aluminum and Non-Ferrous	Hi-Temp Alloy		Hardened Steel (HRc)
	Low Carbon		Alloy		Austenitic	Martensitic	PH	Gray	Nodular		Ni, Co, Fe Based Super Alloy	Titanium	
Hardness	13-38	>38	16-38	> 38	300 Series	400 series		18-22	22-32				>45
Bright	☆		☆		☆			☆	◆	☆			

☆ = Best Performance ◆ = Acceptable

Styles: 4005

Note
 Custom reamer dimensions shown in Technical Section.
 Operating parameters:
 See Technical section

ANSI SIZES

HSS

Thru Holes

Straight Flute

Taper Shank

Surface Treatment

Bright

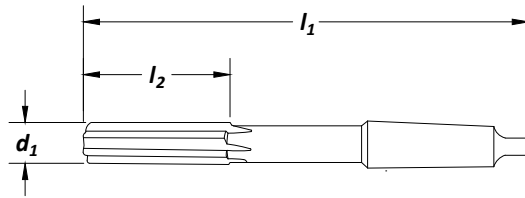

Reamers

High Speed Steel

reamer dia.	decimal	overall length	flute length	morse	number	order number
d₁	equiv.	I₁ (in)	I₂ (in)	taper	of flutes	4005
1/4	.2500	6.000	1.500	1	6	C33842
5/16	.3125	6.000	1.500	1	6	C33986
3/8	.3750	7.000	1.750	1	6	C34129
7/16	.4375	7.000	1.750	1	6	C34266
1/2	.5000	8.000	2.000	1	6	C34400
17/32	.5312	8.000	2.000	1	6	C34467
9/16	.5625	8.000	2.000	1	8	C34534
19/32	.5938	8.000	2.000	1	8	C34601
5/8	.6250	9.000	2.250	2	8	C34668
21/32	.6562	9.000	2.250	2	8	C34735
11/16	.6875	9.000	2.250	2	8	C34802
23/32	.7188	9.000	2.250	2	8	C34867
3/4	.7500	9.500	2.500	2	8	C34932
25/32	.7812	9.500	2.500	2	8	C34997
13/16	.8125	9.500	2.500	2	8	C35063
27/32	.8438	9.500	2.500	2	8	C35128
7/8	.8750	10.000	2.625	2	8	C35193
29/32	.9062	10.000	2.625	2	8	C35258
15/16	.9375	10.000	2.625	3	8	C35323
31/32	.9688	10.000	2.625	3	8	C35389
1"	1.0000	10.500	2.750	3	8	C35454
1-1/16	1.0625	10.500	2.750	3	10	C35461
1-1/8	1.1250	11.000	2.875	3	10	C35469
1-3/16	1.1875	11.000	2.875	3	10	C35476
1-1/4	1.2500	11.500	3.000	4	10	C35483
1-5/16	1.3125	11.500	3.000	4	10	C35490
1-3/8	1.3750	12.000	3.250	4	10	C35497
1-7/16	1.4375	12.000	3.250	4	10	C35505
1-1/2	1.5000	12.500	3.500	4	12	C35512

Material Reference	Steel (HRC)				Stainless Steel			Cast Iron (HRC)		Aluminum and Non-Ferrous	Hi-Temp Alloy		Hardened Steel (HRC)
	Low Carbon		Alloy		Austenitic	Martensitic	PH	Gray	Nodular		Ni, Co, Fe Based Super Alloy	Titanium	
Hardness	13-38	>38	16-38	> 38	300 Series	400 series		18-22	22-32				>45
Bright	☆		☆		☆			☆	◆	☆			

☆ = Best Performance ◆ = Acceptable

Note

Run at carbide speeds.

HSS shank and body for extra strength.

Operating parameters: See Technical section

ANSI
SIZES

HSS



Surface
Treatment



Reamers

High Speed Steel

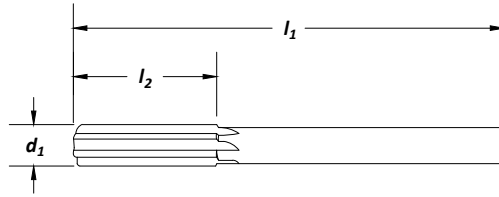

reamer dia.	decimal		overall length	flute length	number	order number
d ₁	equiv.	shank dia.	l ₁ (in)	l ₂ (in)	of flutes	4703
1/4	.2500	.2405	6.000	1.500	4	C50368
9/32	.2812	.2485	6.000	1.500	4	C50382
5/16	.3125	.2792	6.000	1.500	4	C50391
11/32	.3438	.2792	6.000	1.500	4	C50402
3/8	.3750	.3105	7.000	1.750	4	C50414
13/32	.4062	.3105	7.000	1.750	4	C50423
7/16	.4375	.3730	7.000	1.750	6	C50428
15/32	.4688	.3730	7.000	1.750	6	C50433
1/2	.5000	.4355	8.000	2.000	6	C50438
17/32	.5312	.4355	8.000	2.000	6	C50443
9/16	.5625	.4355	8.000	2.000	6	C50449
5/8	.6250	.5620	9.000	2.250	6	C50459

Material Reference	Steel (HRC)				Stainless Steel			Cast Iron (HRC)		Aluminum and Non-Ferrous	Hi-Temp Alloy		Hardened Steel (HRC)
	Low Carbon		Alloy		Austenitic	Martensitic	PH	Gray	Nodular		Ni, Co, Fe Based Super Alloy	Titanium	
Hardness	13-38	>38	16-38	> 38	300 Series	400 series		18-22	22-32				>45
Bright	☆	◆	☆	◆	☆	◆	◆	☆	◆	☆			

☆ = Best Performance ◆ = Acceptable

Taper Shank Bridge Reamer

Style: **616**

Note
Operating parameters:
See Technical section

ANSI
SIZES

HSS



Surface
Treatment

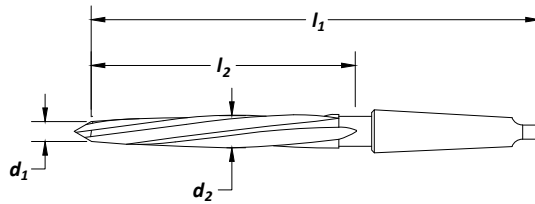

reamer dia. d₂	decimal equiv.	small end dia. d₁ (in)	overall length l₁ (in)	flute length l₂ (in)	morse taper	number of flutes	order number
7/16	.4375	.266	8.250	4.375	2	4	616 C23812
1/2	.5000	.313	9.000	5.125	2	4	C23813
9/16	.5625	.375	9.000	5.125	2	4	C23814
5/8	.6250	.391	10.000	6.125	2	4	C23815
11/16	.6875	.406	11.750	7.125	3	4	C23816
3/4	.7500	.469	12.000	7.375	3	4	C23817
13/16	.8125	.547	12.000	7.375	3	4	C23818
7/8	.8750	.609	12.000	7.375	3	4	C23819
15/16	.9375	.672	12.000	7.375	3	4	C23820
1	1.0000	.734	12.000	7.375	3	4	C23821
1-1/16	1.0625	.813	12.000	7.375	3	4	C23822
1-1/8	1.1250	.859	12.000	7.375	3	4	C23823
1-3/16	1.1875	.922	12.000	7.375	3	4	C23824

Reamers

High Speed Steel

Style: **618**

Taper Shank Car Reamer

Note
Operating parameters:
See Technical section

ANSI
SIZES

HSS



Surface
Treatment

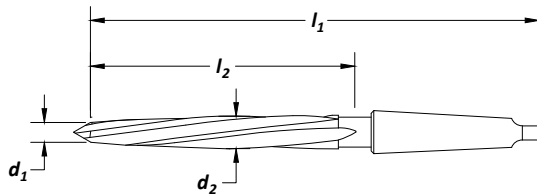

reamer dia. d₂	decimal equiv.	small end dia. d₁ (in)	overall length l₁ (in)	flute length l₂ (in)	morse taper	number of flutes	order number
9/16	.5625	0.313	7.563	3.938	2	5	618 C23957
5/8	.6250	0.328	8.063	4.438	2	5	C23958
11/16	.6875	0.359	8.813	4.438	3	5	C23959
3/4	.7500	0.422	9.500	5.000	3	5	C23960
13/16	.8125	0.469	9.500	5.000	3	5	C23961
15/16	.9375	0.563	9.500	5.000	3	5	C23962

Material Reference	Steel (HRC)		Stainless Steel			Cast Iron (HRC)		Aluminum and Non-Ferrous	Hi-Temp Alloy		Hardened Steel (HRC)
	Low Carbon	Alloy	Austenitic	Martensitic	PH	Gray	Nodular		Ni, Co, Fe Based Super Alloy	Titanium	
	Hardness	13-38	>38	16-38	> 38	300 Series	400 series		18-22	22-32	
Bright	☆		☆					☆	☆		

☆ = Best Performance ◆ = Acceptable

Taper Pipe

Style: **642**

Note

Operating parameters:
See Technical section

ANSI SIZES

HSS

LHS / RHC

Square Shank

Surface Treatment

Bright

Reamers

High Speed Steel

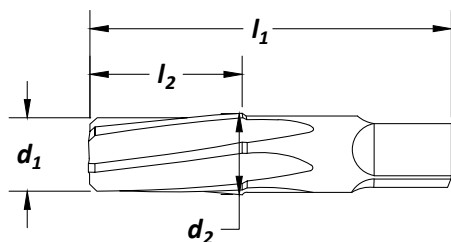

nominal pipe diameter	small end dia. d_1 (in)	large end dia. d_2 (in)	overall length l_1 (in)	flute length l_2 (in)	no. of flutes	order number
1/8	.316	.362	2.125	.750	6	C24982
1/4	.406	.472	2.438	1.063	6	C24983
3/8	.540	.606	2.563	1.063	6	C24984
1/2	.665	.751	3.125	1.375	6	C24985
3/4	.876	.962	3.750	1.375	8	C24986
1	1.103	1.212	3.750	1.750	8	C24987
1-1/4	1.444	1.553	4.000	1.750	10	C24988
1-1/2	1.684	1.793	4.250	1.750	10	C24989

High Spiral Spirex

Taper Pin

Style: **650**

Note

Operating parameters:
See Technical section

ANSI SIZES

HSS

1/4" / 12"

LH Spiral Flute

Surface Treatment

Bright

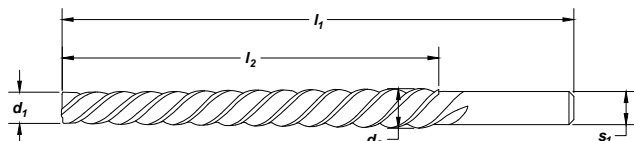

pin size	small end dia. d_1 (in)	large end dia. d_2 (in)	overall length l_1 (in)	flute length l_2 (in)	shank dia. s_1 (in)	order number
#7/0	.0497	.0666	1.813	.813	.0781	C24229
#6/0	.0611	.0806	1.938	.938	.0938	C24230
#5/0	.0719	.0966	2.188	1.188	.1094	C24231
#4/0	.0869	.1142	2.313	1.313	.1250	C24232
#3/0	.1029	.1302	2.313	1.313	.1406	C24233
#2/0	.1137	.1462	2.563	1.563	.1562	C24234
#0	.1287	.1638	2.938	1.688	.1719	C24235
#1	.1447	.1798	2.938	1.688	.1875	C24236
#2	.1605	.2008	3.188	1.938	.2031	C24237
#3	.1813	.2294	3.688	2.313	.2344	C24238
#4	.2071	.2604	4.063	2.563	.2656	C24239
#5	.2409	.2994	4.313	2.813	.3125	C24240
#6	.2773	.3540	5.438	3.688	.3594	C24241
#7	.3297	.4220	6.313	4.438	.4062	C24242
#8	.3971	.5050	7.188	5.188	.4375	C24243
#9	.4805	.6066	8.313	6.063	.5625	C24244
#10	.5799	.7216	9.313	6.813	.6250	C24245

Material Reference	Steel (HRc)				Stainless Steel			Cast Iron (HRc)		Aluminum and Non-Ferrous	Hi-Temp Alloy		Hardened Steel (HRc)
	Low Carbon		Alloy		Austenitic	Martensitic	PH	Gray	Nodular		Ni, Co, Fe Based Super Alloy	Titanium	
	Hardness	13-38	>38	16-38	> 38	300 Series	400 series		18-22	22-32			>45
Bright	☆		☆							☆			

☆ = Best Performance ◆ = Acceptable

Styles: 657, 659
Taper Pin
Straight & Helical Flute
Note
 Operating parameters:
 See Technical section

ANSI SIZES	HSS	1/4" / 12"	LHS / RHC	Straight Flute	Square Shank	Surface Treatment	Bright
------------	-----	------------	-----------	----------------	--------------	-------------------	--------

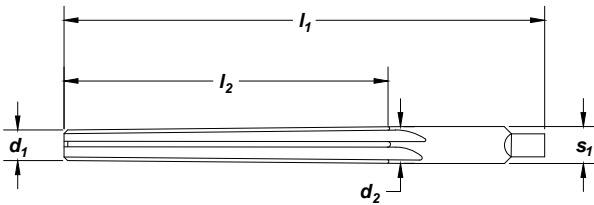

Style 657 - Straight Flute

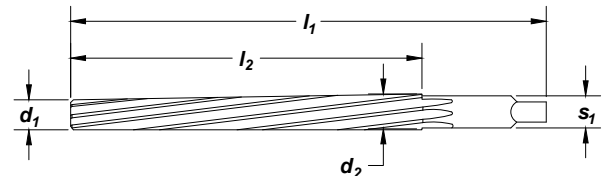

Style 659 - LHH/RHC

Reamers

High Speed Steel

pin size	small end dia. d ₁ (in)	large end dia. d ₂ (in)	overall length l ₁ (in)	flute length l ₂ (in)	shank dia. s ₁ (in)	no. of flutes	order number	
							657 straight flute	659 helical flute
#6/0	.0611	.0806	1.938	.938	.0938	4	C24250	C24271
#5/0	.0719	.0966	2.188	1.188	.1094	4	C24251	C24272
#4/0	.0869	.1142	2.313	1.313	.1250	4	C24252	C24273
#3/0	.1029	.1302	2.313	1.313	.1406	4	C24253	C24274
#2/0	.1137	.1462	2.563	1.563	.1562	4	C24254	C24275
#0	.1287	.1638	2.938	1.688	.1719	4	C24255	C24276
#1	.1447	.1798	2.938	1.688	.1875	6	C24256	C24277
#2	.1605	.2008	3.188	1.938	.2031	6	C24257	C24278
#3	.1813	.2294	3.688	2.313	.2344	6	C24258	C24279
#4	.2071	.2604	4.063	2.563	.2656	6	C24259	C24280
#5	.2409	.2994	4.313	2.813	.3125	6	C24260	C24281
#6	.2773	.3540	5.438	3.688	.3594	6	C24261	C24282
#7	.3297	.4220	6.313	4.438	.4062	6	C24262	C24283
#8	.3971	.5050	7.188	5.188	.4375	6	C24263	C24284
#9	.4805	.6066	8.313	6.063	.5625	6	C24264	C24285
#10	.5799	.7216	9.313	6.813	.6250	6	C24265	C24286

Material Reference	Steel (HRC)		Stainless Steel			Cast Iron (HRC)		Aluminum and Non-Ferrous	Hi-Temp Alloy		Hardened Steel (HRC)
	Low Carbon	Alloy	Austenitic	Martensitic	PH	Gray	Nodular		Ni, Co, Fe Based Super Alloy	Titanium	
	Hardness	13-38	>38	16-38	> 38	300 Series	400 series		18-22	22-32	
Bright	☆		☆					☆	☆	☆	

☆ = Best Performance ◆ = Acceptable

Note
Pilots listed on page 114.

ANSI SIZES

HSS

RH Spiral Flute

Straight Shank

Surface Treatment

Bright

Counterbore

High Speed Steel

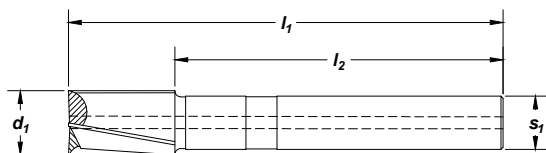

counterbore diameter		pilot shank sizes		shank length	overall length	shank diameter	pilot size range	no. of flutes	order no.
d ₁				I ₂ (in)	I ₁ (in)	S ₁ (in)			879
fraction	in	fraction	in						
3/16	.1875	3/32	.0938	2.125	3.000	.234	1/8 - 3/16	3	C46421
7/32	.2188	3/32	.0938	2.125	3.000	.234	1/8 - 7/32	3	C46422
1/4	.2500	3/32	.0938	3.063	3.813	.234	1/8 - 3/16	3	C46423
9/32	.2812	3/32	.0938	3.063	3.813	.266	1/8 - 7/32	3	C46424
5/16	.3125	3/32	.0938	3.063	3.813	.297	1/8 - 1/4	3	C46425
11/32	.3438	3/32	.0938	3.063	3.813	.313	1/8 - 9/32	3	C46426
3/8	.3750	5/32	.1562	3.063	4.063	.313	3/16 - 5/16	3	C46427
13/32	.4062	5/32	.1562	3.063	4.063	.375	3/16 - 11/32	3	C46428
7/16	.4375	5/32	.1562	3.063	4.063	.375	3/16 - 3/8	3	C46429
15/32	.4688	3/16	.1875	3.063	4.313	.438	1/4 - 13/32	3	C46430
1/2	.5000	3/16	.1875	3.063	4.313	.438	1/4 - 7/16	3	C46431
17/32	.5312	3/16	.1875	3.063	4.313	.500	1/4 - 15/32	3	C46432
9/16	.5625	3/16	.1875	3.063	4.313	.500	1/4 - 1/2	3	C46433
19/32	.5938	3/16	.1875	3.875	5.125	.500	1/4 - 17/32	3	C46434
5/8	.6250	3/16	.1875	3.875	5.125	.500	1/4 - 9/16	3	C46435
21/32	.6562	3/16	.1875	3.875	5.125	.500	1/4 - 19/32	3	C46436
11/16	.6875	3/16	.1875	3.875	5.125	.500	1/4 - 5/8	3	C46437
23/32	.7188	1/4	.2500	3.875	5.375	.500	5/16 - 21/32	3	C46438
3/4	.7500	1/4	.2500	3.875	5.375	.500	5/16 - 11/16	3	C46439
25/32	.7812	1/4	.2500	3.875	5.375	.625	5/16 - 23/32	3	C46440
13/16	.8125	1/4	.2500	3.875	5.375	.625	5/16 - 3/4	3	C46441
7/8	.8750	1/4	.2500	3.875	5.375	.750	5/16 - 13/16	3	C46443
15/16	.9375	1/4	.2500	4.625	6.125	.750	5/16 - 7/8	3	C46445
1	1.0000	5/16	.3125	4.625	6.375	.750	3/8 - 15/16	3	C46447
1-1/16	1.0625	5/16	.3125	4.625	6.375	.750	3/8 - 1	3	C46448
1-1/8	1.1250	5/16	.3125	4.625	6.375	1.000	3/8 - 1-1/16	3	C46449

Material Reference	Steel (HRC)				Stainless Steel			Cast Iron (HRC)		Aluminum and Non-Ferrous	Hi-Temp Alloy		Hardened Steel (HRC)
	Low Carbon		Alloy		Austenitic	Martensitic	PH	Gray	Nodular		Ni, Co, Fe Based Super Alloy	Titanium	
	Hardness	13-38	>38	16-38	> 38	300 Series	400 series		18-22	22-32			>45
Bright	☆		☆					☆	☆	☆			

☆ = Best Performance ◆ = Acceptable

Note

Pilots listed on page 125.

ANSI SIZES	HSS	Straight Shank	Surface Treatment	Bright
------------	-----	----------------	-------------------	--------

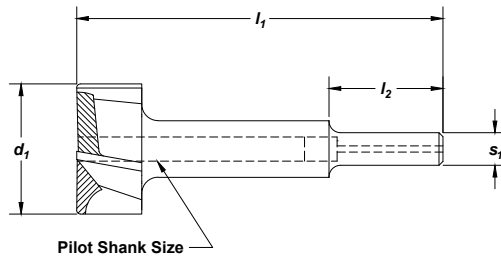

Counterbore

High Speed Steel

counterbore diameter d_1		pilot shank sizes		shank length l_2 (in)	overall length l_1 (in)	shank diameter s_1 (in)	pilot size range	no. of flutes	order no.
fraction	in	fraction	in						884
1/4	.2500	3/32	.0938	1.125	2.375	.250	1/8 - 3/16	4	C46886
5/16	.3125	3/32	.0938	.875	2.375	.250	1/8 - 1/4	4	C46888
3/8	.3750	3/32	.0938	.875	2.375	.250	3/16 - 5/16	4	C46890
13/32	.4062	1/8	.1250	.875	2.813	.250	3/16 - 11/32	4	C46891
7/16	.4375	1/8	.1250	.875	2.813	.250	3/16 - 3/8	4	C46892
15/32	.4688	1/8	.1250	.875	2.813	.250	1/4 - 13/32	4	C46893
1/2	.5000	1/8	.1250	.875	2.813	.250	1/4 - 7/16	4	C46894
9/16	.5625	1/8	.1250	.875	2.813	.250	1/4 - 1/2	4	C46896
5/8	.6250	1/8	.1250	.875	2.813	.250	1/4 - 9/16	4	C46898
11/16	.6875	3/16	.1875	.875	2.813	.250	1/4 - 5/8	4	C46900
3/4	.7500	3/16	.1875	.875	2.813	.250	5/16 - 11/16	4	C46902
13/16	.8125	3/16	.1875	.875	2.813	.250	5/16 - 3/4	4	C46904
7/8	.8750	3/16	.1875	.875	2.813	.250	5/16 - 13/16	4	C46906
15/16	.9375	3/16	.1875	.875	2.813	.250	5/16 - 7/8	4	C46908
1	1.0000	3/16	.1875	.875	2.813	.250	3/8 - 15/16	4	C46910

TECH TIPS

Aircraft Type Counterbores

- Designed for aircraft fabricating use with portable pneumatic and electric drills.
- Smaller pilot holes than standard counterbores.
- Corner radius of 1/32" is standard.

Material Reference	Steel (HRC)				Stainless Steel			Cast Iron (HRC)		Aluminum and Non-Ferrous	Hi-Temp Alloy		Hardened Steel (HRC)
	Low Carbon		Alloy		Austenitic	Martensitic	PH	Gray	Nodular		Ni, Co, Fe Based Super Alloy	Titanium	
Hardness	13-38	>38	16-38	> 38	300 Series	400 series		18-22	22-32				>45
Bright	☆		☆					☆	☆	☆			

☆ = Best Performance ◆ = Acceptable

Note

For pilot diameter, match pilot shank size, from style #884 or #879, to pilot shank size S_1 in these columns.

ANSI
SIZES

HSS

Surface
Treatment

Bright

Counterbore

High Speed Steel

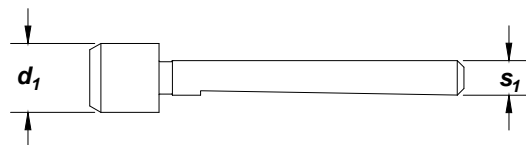

pilot diameter d_1	decimal equiv.	S_1 order number 879P							
		3/32"	1/8"	5/32"	3/16"	1/4"	5/16"	3/8"	7/16"
3/32	.0938	C46520	-	-	-	-	-	-	-
.127	.1250	C46525	-	-	-	-	-	-	-
1/8	.1250	C46523	C46522	-	-	-	-	-	-
5/32	.1562	C46528	C46527	C46529	-	-	-	-	-
.157	.1570	C46531	-	-	-	-	-	-	-
.159	.1590	C46533	-	-	-	-	-	-	-
3/16	.1875	C46538	C46537	C46539	C46540	-	-	-	-
.191	.1910	C46545	C46544	-	C46546	-	-	-	-
13/64	.2031	-	C46547	-	-	-	-	-	-
7/32	.2188	C46549	C46548	C46550	C46551	-	-	-	-
1/4	.2500	C46554	C46553	C46555	C46556	C46557	-	-	-
.255	.2550	-	C46558	-	C46560	-	-	-	-
9/32	.2812	-	-	C46565	C46566	-	-	-	-
5/16	.3125	C46570	C46569	C46571	C46572	C46573	-	-	-
11/32	.3438	-	C46576	C46578	C46579	C46580	-	-	-
3/8	.3750	C46314	C46583	C46584	C46585	C46586	C46587	-	-
13/32	.4062	-	-	-	C46592	C46593	C46594	-	-
7/16	.4375	-	-	C46597	C46598	C46599	C46600	-	-
15/32	.4688	-	-	-	C46605	-	-	-	-
1/2	.5000	-	-	-	C46612	C46613	C46614	-	-
17/32	.5312	-	-	-	C46620	C46621	C46622	-	-
9/16	.5625	-	-	-	-	C46629	C46630	-	-
19/32	.5938	-	-	-	-	-	-	C46639	-
5/8	.6250	-	-	-	-	C46645	-	C46647	-
11/16	.6875	-	-	-	-	C46657	C46658	C46659	-
3/4	.7500	-	-	-	C46316	-	-	C46669	-
25/32	.7812	-	-	-	-	-	C46673	C46674	-
13/16	.8125	-	-	-	-	-	C46678	C46679	-
7/8	.8750	-	-	-	-	C46687	-	-	-
1	1.0000	-	-	-	-	-	-	-	-
1-1/16	1.0625	-	-	-	-	-	-	-	C46716
1-1/8	1.1250	-	-	-	-	-	-	C46723	-

Material Reference	Steel (HRC)				Stainless Steel			Cast Iron (HRC)		Aluminum and Non-Ferrous	Hi-Temp Alloy		Hardened Steel (HRC)
	Low Carbon		Alloy		Austenitic	Martensitic	PH	Gray	Nodular		Ni, Co, Fe Based Super Alloy	Titanium	
	Hardness	13-38	>38	16-38	> 38	300 Series	400 series		18-22	22-32			>45
Bright	☆		☆					☆	☆	☆			

☆ = Best Performance ◆ = Acceptable

Style: **655**

ANSI SIZES HSS Straight Shank Surface Treatment Bright

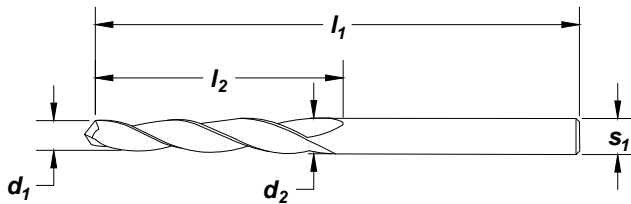

Counterbore

High Speed Steel

size number	shank diameter s_1 (in)	small end diameter d_1 (in)	large end diameter d_2 (in)	flute length l_2 (in)	overall length l_1 (in)	order no. 655
#1	.098	.081	.0980	.813	2.000	C24292
#2	.128	.110	.1280	.875	2.250	C24293
#3	.188	.165	.1875	1.063	2.500	C24294
#4	.250	.224	.2500	1.250	2.750	C24295

TECH TIPS

Clearance or Taper Router

- Use for cutting, trimming, routing, and elongating existing holes.

Material Reference	Steel (HRc)				Stainless Steel			Cast Iron (HRc)		Aluminum and Non-Ferrous	Hi-Temp Alloy		Hardened Steel (HRc)
	Low Carbon		Alloy		Austenitic	Martensitic	PH	Gray	Nodular		Ni, Co, Fe Based Super Alloy	Titanium	
Hardness	13-38	>38	16-38	> 38	300 Series	400 series		18-22	22-32				>45
Bright	☆		☆					☆	☆	☆			

☆ = Best Performance ◆ = Acceptable

ANSI
SIZESDIN
1897

HSS

Straight
ShankSurface
Treatment

Bright

Counterbore

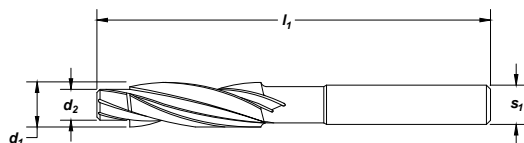

High Speed Steel

counterbore number	cutter diameter d_1 (in)	pilot diameter d_2 (in)	shank diameter s_1 (in)	overall length l_1 (in)	cap screw size	order no. 183
183-CSS-6	.230	.135	.219	3.000	No. 6	C91695
183-CSS-7	.242	.150	.219	3.000	No. 6	C91696
183-CSS-8	.274	.161	.250	3.000	No. 8	C91697
183-CSS-9	.286	.178	.250	3.000	No. 8	C91698
183-CSS-10	.316	.187	.313	3.500	No. 10	C91699
183-CSS-11	.328	.204	.313	3.500	No. 10	C91700
183-CSS-12	.348	.213	.344	3.500	No. 12	C91701
183-CSS-16	.375	.250	.375	3.500	No. 12	C91703
183-CSS-17	.391	.266	.375	5.750	1/4	C92704
183-CSS-18	.406	.281	.375	5.750	1/4	C92705
183-CSM-6	.433	.268	.438	6.000	6mm	C91830
183-CSS-20	.438	.313	.438	6.000	5/16	C92706
183-CSS-21	.453	.328	.438	6.000	5/16	C92708
183-CSS-20-60	.469	.313	.438	6.000	5/16	C92707
183-CSS-22	.469	.344	.438	6.000	5/16	C91710
183-CSS-21-60	.484	.328	.438	6.000	5/16	C91709
183-CSS-22-60	.500	.344	.438	6.000	5/16	C91711
183-CSS-24	.563	.375	.500	6.500	3/8	C91712
183-CSS-25	.578	.391	.500	6.500	3/8	C91713
183-CSS-26	.594	.406	.500	6.500	3/8	C91714
183-CSS-28	.625	.438	.500	7.000	7/16	C91715
183-CSS-29	.641	.453	.500	7.000	7/16	C91717
183-CSS-30	.656	.469	.500	7.000	7/16	C91719
183-CSS-30-60	.688	.469	.500	7.000	7/16	C91720
183-CSM-10	.709	.433	.500	7.000	10mm	C91832
183-CSS-32	.750	.500	.500	7.250	1/2	C91721
183-CSS-33	.766	.516	.500	7.250	1/2	C91722
183-CSS-34	.781	.531	.500	7.250	1/2	C91723
183-CSM-12	.787	.531	.500	7.000	12mm	C91833
183-CSS-36	.813	.563	.750	7.500	9/16	C91724
183-CSS-40	.875	.625	.750	8.250	5/8	C91726
183-CSS-42	.906	.656	.750	8.250	5/8	C91728
183-CSS-42-60	.969	.656	.750	8.250	5/8	C91729
183-CSM-16	1.024	.689	.750	8.250	16mm	C91834
183-CSS-50	1.031	.781	1.000	8.813	3/4	C91734
183-CSS-50-60	1.156	.781	1.000	8.813	3/4	C91735
183-CSS-52-60	1.188	.813	1.000	8.813	3/4	C91737
183-CSM-20	1.299	.866	1.000	8.813	20mm	C91835
183-CSS-68-60	1.563	1.063	1.000	8.813	1	C91749
183-CSM-24	1.575	1.024	1.000	8.813	24mm	C92836

set number	no. of pieces	size range	order number
183-CSS-1	9	CSS-6, -8, -10, -12, -16, -20, -24, -28, -32	C91750
183-CSS-3	8	CSS-18, -20-60, -21-60, -22-60, -22, -26, -30, -34	C91770

Counterbore
High Speed Steel

Material Reference	Steel (HRc)				Stainless Steel			Cast Iron (HRc)		Aluminum and Non-Ferrous	Hi-Temp Alloy		Hardened Steel (HRc)
	Low Carbon		Alloy		Austenitic	Martensitic	PH	Gray	Nodular		Ni, Co, Fe Based Super Alloy	Titanium	
Hardness	13-38	>38	16-38	> 38	300 Series	400 series		18-22	22-32				>45
Bright	☆		☆					☆	☆				

☆ = Best Performance ◆ = Acceptable

Screw Machine / Stub Length Drills

Image	Type	Style	Order No.	Number of pieces	Surface Treatment				Material		Size Range	Case Type		
					Bright	Black Oxide	Straw Oxide	TIN	HSS	Cobalt		Metal	Plastic	
	General Purpose	2120	C00980	29	•	•	•	•	•	•	1/16" through 1/2" x 1/64"	•	•	
			C01332	26	•	•	•	•	•	•	letter A through Z	•	•	
	NAS907-C Heavy Duty	2330	C70370	15	•	•	•	•	•	•	1/16" through 1/2" x 1/32"	•	•	
			C70369	21	•	•	•	•	•	•	•	1/16" through 3/8" x 1/64"	•	•
			C70368	29	•	•	•	•	•	•	•	1/16" through 1/2" x 1/64"	•	•



Jobber Drills

Image	Type	Style	Order No.	Number of pieces	Surface Treatment				Material		Size Range	Case Type			
					Bright	Black Oxide	Straw Oxide	TIN	HSS	Cobalt		Metal	Plastic		
	General Purpose	2001G	C72197	29	•	•	•	•	•	•	1/16" through 1/2" x 1/64"	•	•		
			C71000	25	•	•	•	•	•	•	•	1 mm through 13 mm x 0.5 mm	•	•	
			C00960	50	•	•	•	•	•	•	•	•	1 mm through 5.9 mm x 0.1 mm	•	•
	General Purpose	2002G	C72199	15	•	•	•	•	•	•	1/16" through 1/2" x 1/32"	•	•		
			C72198	29	•	•	•	•	•	•	•	1/16" through 1/2" x 1/64"	•	•	
			C00939	26	•	•	•	•	•	•	•	•	letter A through Z	•	•
			C00934	60	•	•	•	•	•	•	•	•	wire gauge #1 through #60	•	•
			C01330	115	•	•	•	•	•	•	•	•	1/16" through 1/2" x 1/16", A through Z and #1 through #60	•	•
			C72000	25	•	•	•	•	•	•	•	•	1 mm through 13 mm x 0.5 mm	•	•
	General Purpose	2002	C00937	20	•	•	•	•	•	•	#61-#80	•	•		
			Q-Cobalt Wide Land Parabolic	2075	C00901	15	•	•	•	•	•	•	1/16" through 1/2" x 1/32"	•	•
C00902	29	•			•	•	•	•	•	•	1/16" through 1/2" x 1/64"	•	•		
	NAS907-B Heavy Duty	2222	C70371	20	•	•	•	•	•	•	1/16" through 1/2" x 1/64"	•	•		
	NAS907-J Heavy Duty	2213	C70365	29	•	•	•	•	•	•	1/16" through 1/2" x 1/64"	•	•		
			C00986	26	•	•	•	•	•	•	•	A through Z letter	•	•	
			C70366	60	•	•	•	•	•	•	•	#1 through #60 wire gauge	•	•	
			C70367	115	•	•	•	•	•	•	•	1/16" through 1/2" x 1/64", A through Z and #1 through #60	•	•	
	Q-AMD Short Flute	3780	C14499	29	•	•	•	•	•	•	1/16" through 1/2" x 1/64"	•	•		

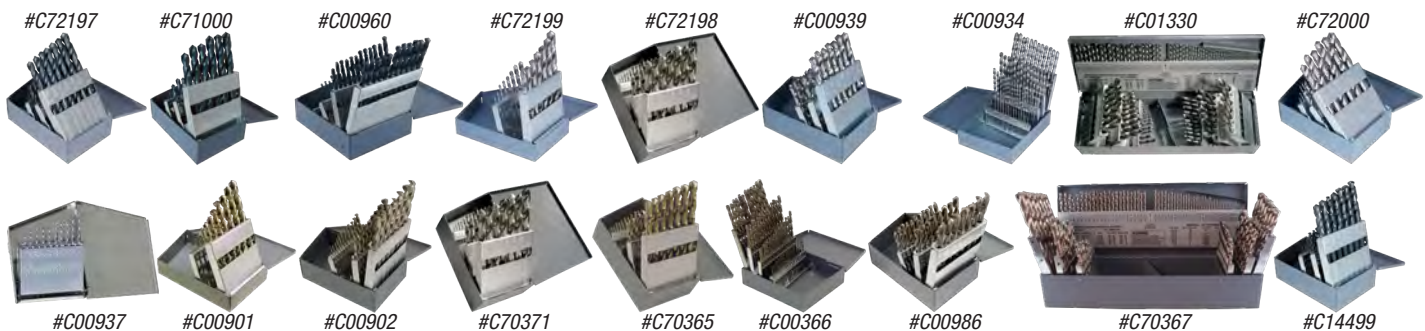

Cost Saving Sets

Sets

SETS

Taper Length Drills

Image	Type	Style	Order No.	Number of pieces	Surface Treatment					Material		Size Range	Case Type	
					Bright	Black Oxide	Straw Oxide	TIN	HSS	Cobalt	Metal		Plastic	
	General Purpose	2510	C00962	29	•	•	•	•	•	•	1/16" through 1/2" x 1/64"	•	•	

Misc. Drills

Image	Type	Style	Order No.	Number of pieces	Surface Treatment					Material		Size Range	Case Type	
					Bright	Black Oxide	Straw Oxide	TIN	HSS	Cobalt	Metal		Plastic	
	Spotting / Centering	2636	C26173	6	•	•	•	•	•	•	90° - 1/4" through 1" (short)	•	•	
			C26180	6	•	•	•	•	•	•	120° - 1/4" through 1" (short)	•	•	
		2646	C26187	6	•	•	•	•	•	•	•	90° - 1/4" through 1" (long)	•	•
			C26194	6	•	•	•	•	•	•	•	120° - 1/4" through 1" (long)	•	•
		2635	C24173	6	•	•	•	•	•	•	•	90° - 1/4" through 1" (short)	•	•
			C24180	6	•	•	•	•	•	•	•	120° - 1/4" through 1" (short)	•	•
2645	C24187	6	•	•	•	•	•	•	•	90° - 1/4" through 1" (long)	•	•		
	C24194	6	•	•	•	•	•	•	•	120° - 1/4" through 1" (long)	•	•		
	Countersink / Deburring	3001	C94588	4	•	•	•	•	•	•	60° - 5/16, 3/8, 1/2, 5/8	•	•	
			C94589	4	•	•	•	•	•	•	82° - 5/16, 3/8, 1/2, 5/8	•	•	
			C94590	4	•	•	•	•	•	•	•	90° - 5/16, 3/8, 1/2, 5/8	•	•
			C94591	4	•	•	•	•	•	•	•	100° - 5/16, 3/8, 1/2, 5/8	•	•
			C94592	5	•	•	•	•	•	•	•	60° - 5/16, 3/8, 1/2, 3/4, 1	•	•
			C94593	5	•	•	•	•	•	•	•	82° - 5/16, 3/8, 1/2, 3/4, 1	•	•
			C94594	5	•	•	•	•	•	•	•	90° - 5/16, 3/8, 1/2, 3/4, 1	•	•
C94595	5	•	•	•	•	•	•	•	100° - 5/16, 3/8, 1/2, 3/4, 1	•	•			
	Countersink / Drill Plain	998	C00944	5	•	•	•	•	•	#1 through #5	•	•		
	Single Flute Countersink	10001	C00970	5	•	•	•	•	•	•	60° - 1/4" through 3/4" x 1/8"	•	•	
			C00971	5	•	•	•	•	•	•	82° - 1/4" through 3/4" x 1/8"	•	•	
	3 Flute Countersink	10003	C00972	5	•	•	•	•	•	•	60° - 1/4" through 3/4" x 1/8"	•	•	
			C00973	5	•	•	•	•	•	•	82° - 1/4" through 3/4" x 1/8"	•	•	
	4 Flute Reamer / Countersink	610	C00969	5	•	•	•	•	•	82° - 1/4" through 3/4" x 1/8"	•	•		

#C26173



#C24173



#C24180



#C24187



#C24194



#C00944



Reamers

Image	Type	Style	Order No.	Number of pieces	Surface Treatment					Material		Size Range	Case Type	
					Bright	Black Oxide	Straw Oxide	TIN	HSS	Cobalt	Metal		Plastic	
	Straight Shank, Straight Flute	4001	C00964	29	•	•	•	•	•	•	1/16" through 1/2" x 1/64"	•	•	

Counterbores

Image	Type	Style	Order No.	Number of pieces	Surface Treatment					Material		Size Range	Case Type	
					Bright	Black Oxide	Straw Oxide	TIN	HSS	Cobalt	Metal		Plastic	
	3 Flute Continuous Pilot	183 <i>(Set #183-CSS-1)</i>	C91750	9	•	•	•	•	•	•	#C91750 #C91770 CSS-6, -8, -10, -12, -16, -20, -24, -28, -32	•	•	
		183 <i>(Set #183-CSS-3)</i>	C91770	8	•	•	•	•	•	•	CSS-18, -20-60, -21-60, -22-60, -22, -26, -30, -34	•	•	



Technical Information

Nomenclature	124	Operating Parameters	131
High Speed Steel Drills		Drill Cutting Speeds	132
Material Class	125	Dimensional Specifications	135
Operating Parameters	126	Shank / Tang	141
Surface Treatments	127	Morse Taper Shank	141
Special Drills	127	Reamers	
Common Shank Drills		Custom Reamers	142
Speeds & Feeds	128	Reamer Speeds and Feeds	144
Drilling Method	129	Tolerances / Regrinding	145
Cobalt Drills		Reamer Cutting Speeds	146
Material Class	130		

Drill Nomenclature

Axis

The imaginary straight line which forms the longitudinal center line of the drill.

Back Taper

A slight decrease in diameter, from front to back in the body of the drill.

Body

The portion of the drill extending from the shank or neck to the outer corners of the cutting lips.

Body Diameter Clearance

That portion of the land that has been cut away so it will not rub against the walls of the hole.

Chisel Edge

The edge at the end of the web that connects the cutting lips.

Drill Diameter

The diameter over the margins of the drill measured at the point.

Flutes

Helical or straight grooves cut or formed in the body of the drill to provide cutting lips, to permit removal of chips, and to allow cutting fluid to reach the cutting lips.

Flute Length

The length from the outer corners of the cutting lips to the extreme back end of the flutes. However, metric drills are measured from the extreme end of the shank to the end of the flute at the point.

Land

The peripheral portion of the body between adjacent flutes.

Land Width

The distance between the leading edge and the heel of the land measured at a right angle to the leading edge.

Lip Relief

The axial relief on the drill point.

Margin

The cylindrical portion of the land which is not cut away to provide clearance.

Neck

The section of reduced diameter between the body and the shank of a drill.

Overall Length

The length from the extreme end of the shank to the outer corners of the cutting lips. However, metric drills are measured from the extreme end of the shank to the end of the flute at the point.

Point

The cutting end of a drill, made up of the ends of the lands and the web. In form it resembles a cone, but departs from a true cone to furnish clearance behind the cutting lips.

Point Angle

The angle included between the cutting lips projected upon a plane parallel to the drill axis and parallel to the two cutting lips.

Shank

The part of the drill by which it is held and driven.

Tang

The flattened end of a taper shank, intended to fit into a driving slot in a socket.

Web

The central portion of the body that joins the lands. The extreme end of the web forms the chisel edge on a two flute drill.

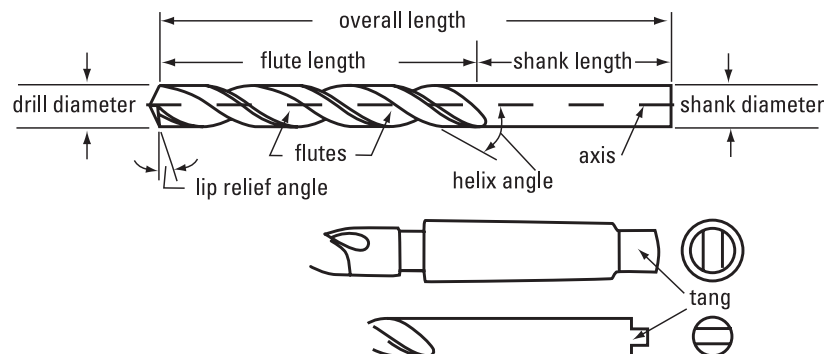
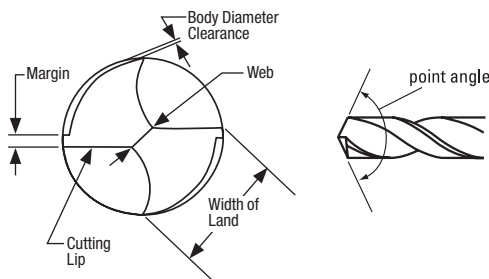

Recommended Surface Feet per Minute (SFM) and Coolant by Material Application
Ferrous Materials

Materials	Brinell Hardness	geometry	SFM	coolant
Low Carbon Steel	85-125	general-purpose	80-95	soluble oil
Medium Carbon Steel	125-175	general-purpose	70-85	soluble oil
High Carbon Steel	175-225	heavy-duty	45-65	soluble oil
Steels Alloyed	under 200	general-purpose	60-90	soluble oil
	200-300	heavy-duty	40-70	soluble oil
	over 300	cobalt	20-30	soluble oil
Steel Drop Forgings Heat Treated	330-370		30-40	cutting oil
	370-420		20-30	cutting oil
	over 420		10-20	cutting oil
Grey Cast Iron Soft	125	general-purpose	140-150	dry
Grey Cast Iron Medium	120-200	heavy-duty	50-80	soluble oil
Grey Cast Iron Hard	up to 350	heavy-duty	25-40	soluble oil
Titanium Alloys (Ti)-75A	300-440	cobalt	50-60	cutting oil
Ti-150A, RS-120	300-440	cobalt	40-50	cutting oil
Ti-140A, RC 130B	300-440	cobalt	30-40	cutting oil
Ti-6AL -4V	300-440	cobalt	20-30	cutting oil
300 Series Stainless	120-200	cobalt	20-40	cutting oil
400 Series Stainless	200-300	cobalt	40-70	cutting oil
Martensitic 416, 420, F416 Plus K, 400F, 416SE, 440F	135-185	cobalt	40-50	cutting oil
Precipitation Hardening	325-375	cobalt	30	cutting oil
Stainless Steel, Cast	400-450	cobalt	20	cutting oil
Heat Resisting Steels	175-225	cobalt	10-25	cutting oil
Nimonic Alloys	200-300	cobalt	10-20	cutting oil
Manganese 12-14% min	125-220	heavy-duty	10-12	cutting oil
Spring Steels	402	cobalt	15-30	soluble oil
Armor Plate	200-250	cobalt	40	soluble oil
	250-300	cobalt	35	soluble oil
	300-350	cobalt	30	cutting oil

Non-Ferrous Materials

Materials	Brinell Hardness	geometry	SFM	coolant
Aluminum Pure	140-350	fast spiral*	130-200	soluble oil
Aluminum Alloys	140-330	fast spiral*	150-300	soluble oil
Aluminum Leaded	40-100	fast spiral*	200-325	soluble oil
Aluminum Silicon Alloy Die Cast	40-100	fast spiral*	25-50	soluble oil
Brass	190-210	slow spiral*	200-250	cutting or soluble oil
Bronze	150-200	slow spiral*	200-250	soluble oil
Copper - Nickel & Copper Tin Alloy	65-100	general-purpose*	140-200	cutting or soluble oil
Copper - Aluminum Alloys	30-100	general-purpose*	120-200	cutting or soluble oil
Magnesium Alloys - Wrought	50-90	general-purpose*	140-330	cutting or soluble oil
Magnesium Alloys - Cast	50-90	general-purpose*	140-365	cutting or soluble oil
Nickel Alloys - Wrought and Cast	80-170	cobalt	15-20	cutting or soluble oil
Nickel Alloys - Monel	115-240	cobalt	15-20	cutting or soluble oil
Nickel Alloys - Beryllium Nickel	200-250	cobalt	10-12	cutting or soluble oil
Zinc Alloy	112-126	general-purpose	200-250	soluble oil

**bright only*

Determining Feed and Speed

This Cleveland catalog offers starting feed and speed parameters for each style of tool. The recommended operating parameters are found in front of each tool style for high-performance tools and in the beginning of the general application section for those tools. Drill cutting speed tables for individual sizes of drills can be found in this section, titled "Drill Cutting Speeds".

To determine your own starting speeds and feeds, follow this procedure.

Look up the material to be drilled in the Recommended SFM (surface feet per minute) by material class table in this section, titled "Material Class" and determine the geometry class.

Determine the drill style from the Drill Style by Geometry and Length/Construction table on page 3 based on recommended drill type and drill length desired.

Review each drill style to understand the geometry differences. Select the appropriate geometry and check to ensure the desired size is available.

Starting speed and feed recommendations for the drill can be determined from the formulas below.

Recommended operating parameters for high-performance drills are generally 20% faster than for conventional geometries and are shown with the individual drill styles. Feed rates for high performance drills are heavier than for conventional geometries by 50% or more.

Drill Diameter Tolerances

Diameter Range (inches)	Plus (+) (inches)	Minus (-) (inches)
through 1/8	.0000	.0005
over 1/8 through 1/4	.0000	.0007
over 1/4 through 1/2	.0000	.0010
over 1/2 through 1	.0000	.0012
over 1 through 2	.0000	.0015
over 2 through 3-1/2	.0000	.0020

Drill Overall Length and Flute Length Tolerances

Diameter Range (inches)	Plus (+) (inches)	Minus (-) (inches)
#80 through 1/8	.1250	.0625
over 1/8 through 1/2	.1250	.1250
over 1/2 through 1	.2500	.1250
over 1 through 2	.2500	.2500
over 2 through 3-1/2	.3750	.3750

Drill Point Angle Tolerances

Diameter Range (inches)	Included Angle (degrees)	Tolerance (degrees)
1/16 through 1/2	118° or 135°	± 5°
over 1/2 through 1-1/2	118°	± 3°
over 1-1/2 through 3-1/2	118°	± 2°

Drill Lip Height Tolerances

Diameter Range (inches)	Total Indicator Variation (inches)
1/16 through 1/8	.0020
over 1/8 through 1/4	.0030
over 1/4 through 1/2	.0040
over 1/2 through 1	.0050
over 1 through 3-1/2	.0060

Drill Definitions

RPM = revolutions per minute
 SFM = surface feet per minute
 FR = feed rate in inches per minute
 IPR = inches per revolution

Drill Formula

RPM = 3.8 x SFM/drill diameter
 SFM = 0.26 x RPM x drill diameter
 FR = RPM x IPR

Drill Feeds

Diameter Range (inches)	IPR (inches per revolution)	
	Normal Feeds	Heavy Feed
1/16 through 1/8	.001 - .002	.002 - .004
over 1/8 through 1/4	.002 - .004	.004 - .008
over 1/4 through 1/2	.004 - .008	.008 - .016
over 1/2 through 1	.008 - .016	.016 - .024
over 1	.016 - .024	.024 - .032

Surface Treatment	Recommended Applications	Precautions
TiN (Titanium Nitride)	For ferrous and non-metallic materials: free-machining steels and irons, high tensile steels, tough machining steels, plastics, hard rubber, and fiber. The hard, smooth treatment increases tool life, improves finish, and allows higher speeds.	Avoid titanium and titanium alloys due to tendency to gall.
TiCN (Titanium Carbonitride)	For ferrous and non-ferrous materials: cast iron, aluminum, stainless steel, brass, abrasive materials, high-silicon automotive aluminum, glass-filled plastics, and composites. The hard, smooth treatment increases tool life and improves finish.	Use with caution in titanium, titanium alloys, and aluminum die casting due to tendency to gall.
TiAlN (Titanium Aluminum Nitride)	For ferrous materials, high-temperature alloys, and titanium: stainless steels, gray cast irons or nodular irons, and steels containing high-nickel, cobalt, chromium, and tungsten. Most effective where higher speeds are available.	Avoid in most non-ferrous materials.
CrN (Chromium Nitride)	For non-ferrous materials: brass, bronze, zinc alloys, and magnesium alloys. CrN is medium-hard and has a lower wear resistance than TiN, TiCN, and TiAlN. However, unlike these treatments, CrN does not gall in non-ferrous materials.	Ineffective in ferrous materials.

TECHNICAL
High Speed Steel

Special Drills

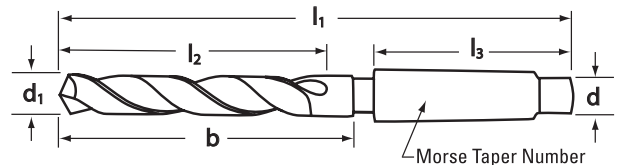
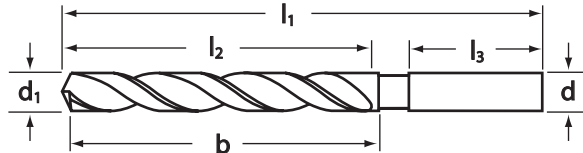

If you know the specs for your special tool, please send a blueprint and/or provide this information:

- Material/hardness to be drilled.
- d = shank diameter or size.**
 - If standard taper shank is ordered, specify as No. 2 American National Standard Taper, No. 3 American National Standard Taper, etc.
 - If taper shank is special, give diameter at small end, length of shank, diameter at large end, taper per foot, and furnish a sample of gauge if possible.
 - If tang is special, give thickness and length.

b = body length.

d¹ = diameter of fluted section. For multiple diameter drills, indicate the diameter of the large fluted section

l¹ = overall length.

- When ordering extra-length drills, specify: type of material being drilled, depth of hole, whether drilling in a vertical or horizontal position, and whether feed is intermittent or with only occasional withdrawals.

l² = flute length.

l³ = shank length.

For multiple-diameter drills, provide:

- the diameter of the small, fluted section
- the included angle of cutting shoulder. Note: this is measured as an angle between the two cutting edges (included angle) and not as an angle with the center line.
- the length of small diameter. Note: this is measured from the outer corner of the point to the bottom or inner corner of the cutting shoulder.

For special accuracy requirements, give tolerances on the important dimensions.

For assistance in designing your special tool, provide

- Workpiece material hardness
- Hole diameter
- Depth of hole
- Thru hole or blind hole
- Shank type
- Coolant or non-coolant
- Step length if necessary
- Step angle

Make sure that suitable allowance has been made for re-sharpening and for clearance for the spindle above the drill bushings. If a particular style of flute-construction is desired, it should be specified by reference to the regular drill of the required flute-style.

Speed & Feeds

TECHNICAL
Carbide

ISO	Material Group	Tensile Strength (N/mm ²) Rockwell Hardness (HRc)	Average Cutting Speed Vc (SFM)					
			5xD		8xD		12xD	
			Vc	Feed Ltr	Vc	Feed Ltr	Vc	Feed Ltr
P	Structural Steel	≤ 25 HRC (≤ 850 N/mm ²)	459	E	344	E	312	D
	Heat Treatable, Case Hardening, Free Cutting Steels	≤ 42 HRC (≤ 1300 N/mm ²)	443	E	312	E	295	E
M	Stainless Steels	≤ 23 HRC (500 - 800 N/mm ²)	180	B	148	B	131	B
	Heat Resisting Steels	≤ 23 HRC	180	C	148	C	131	C
K	Cast Material	≤ 22 HRC	541	F	476	F	361	F
	Cast Material	≤ 30 HRC	476	F	361	F	312	F
S	Titanium Materials	≤ 23 HRC (800 N/mm ²)	148	C	131	C	98	C
	Titanium Alloys	≤ 38 HRC (1200 N/mm ²)	131	C	115	C	82	C
H	Hardened Steels	≤ 60 HRC	115	A	115	A	82	A

Feed Ltr	Nominal Diameter mm - Inch per rev					
	2.5mm (0.098")	4mm (0.1575")	6.3mm (0.2362")	10mm (0.3932")	16mm (0.6300")	25mm (0.9842")
A	0.001	0.002	0.002	0.004	0.005	0.008
B	0.002	0.002	0.003	0.005	0.006	0.010
C	0.002	0.003	0.004	0.006	0.008	0.012
D	0.002	0.004	0.005	0.008	0.010	0.016
E	0.003	0.005	0.006	0.010	0.012	0.020
F	0.004	0.006	0.008	0.012	0.016	0.025

Drilling method for Cleveland® 12x diameter common shank drill

1. Create guide hole using Cleveland® carbide common shank 3x diameter drill.

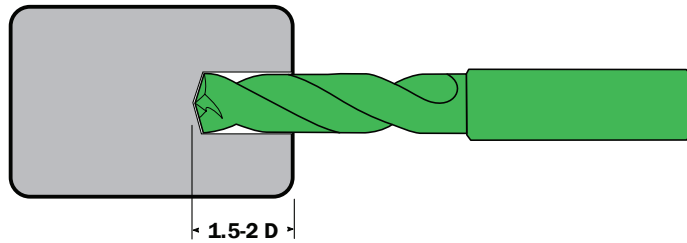

2. Insert the 12x diameter drill at low RPM and feed (500 RPM / 40-80 IPM).

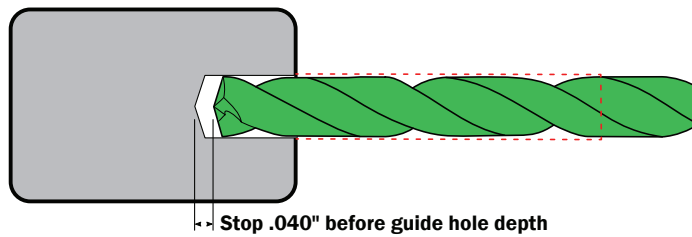

3. Increase rotation to full speed and begin normal drilling cycle.

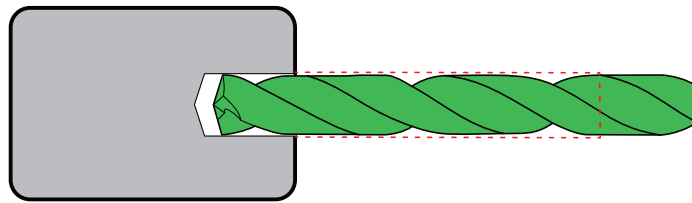

4. After drilling is complete, reduce RPM and feed during retract (500 RPM / 40-80 IPM).

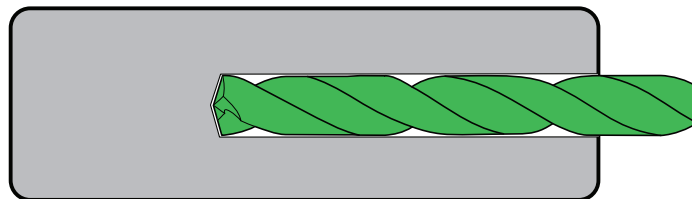
Important Note:

If the hole to be drilled is on a curved surface, or otherwise not perpendicular to the drilling axis, a flat must be cut for accurate drilling.

Coolant Options:

Through spindle coolant or minimum quantity lube (MQL) through spindle coolant.

Material Class

Technical Information

TECHNICAL

		Speeds (SFM) Drill Surface Treatment				Feed Rate (IPR) increase by 25% for TiCN				
Ferrous Material										
Material	Hardness	Bright, Black Oxide & Straw	TiN	TiCN	TiAlN	1/8" 3.17mm	1/4" 6.35mm	3/8" 9.52mm	1/2" 12.70mm	
low carbon steel	85-125 Bhn	90	125	135	–	.0040	.0065	.0080	.0100	
medium carbon steel	125-175 Bhn	90	125	135	–	.0040	.0065	.0080	.0100	
high carbon steel	175-225 Bhn	90	125	135	–	.0030	.0050	.0065	.0080	
alloyed steel	200-300 Bhn	60	80	90	–	.0025	.0040	.0050	.0065	
heat-treatable steel and forgings	370-420 Bhn	40	50	60	70	.0025	.0040	.0050	.0065	
tool steels	< 24 HRC	60	80	90	110	.0030	.0050	.0065	.0080	
	> 24-30 HRC	30	40	45	55	.0025	.0040	.0050	.0065	
high-speed steels	14-30 HRC	35	50	55	60	.0025	.0040	.0050	.0065	
gray cast iron	240 Bhn	115	160	175	–	.0050	.0080	.0100	.0125	
	<300 Bhn	90	125	135	–	.0050	.0080	.0100	.0125	
malleable cast iron	<300 Bhn	70	95	105	–	.0050	.0080	.0100	.0125	
chilled cast iron	<350 Bhn	25	35	40	–	.0025	.0040	.0050	.0065	
stainless steel	300 series (Austenitic)	120-200 Bhn	60	80	90	100	.0025	.0040	.0050	.0065
	400 series (Martensitic)	200-300 Bhn	40	50	60	80	.0025	.0040	.0050	.0065
sulphurized	> 25 HRC	45	65	70	80	.0025	.0040	.0050	.0065	
spring steel	400 Bhn	25	35	40	45	.0020	.0030	.0040	.0050	

Non-Ferrous Material									
Material	Hardness	Bright, Black Oxide & Straw	TiN	TiCN	TiAlN	1/8" 3.17mm	1/4" 6.35mm	3/8" 9.52mm	1/2" 12.70mm
aluminum and aluminum alloys	40-100 Bhn	180	–	–	–	.0050	.0080	.0100	.0125
cast aluminum	< 10% Si	200 Bhn	200	275	–	.0050	.0080	.0100	.0125
	> 10% Si	200 Bhn	180	225	–	250	.0040	.0065	.0080
brass, long chipping	190-210 Bhn	150	–	–	–	.0040	.0065	.0080	.0100
bronze, long chipping	150-200 Bhn	90	115	–	130	.0030	.0050	.0065	.0080
copper, low alloy	65-100 Bhn	120	145	–	–	.0040	.0065	.0080	.0100
plastics, duraplastics	N/A	55	75	80	–	.0030	.0050	.0065	.0080

The speeds and feeds listed here are conservative recommendations for initial setup. In actual use, depending on the machine environment and workpiece material, significantly higher speeds and feeds may be achievable.

Use these speeds and feeds as a starting point. Cutting conditions can be gradually adjusted until the optimum settings for the application are found.

Questions? Contact Technical Support at 800.892.4281.



Q-Cobalt Advantages

- Deliver close hole tolerance for high-precision work.
- Use higher speeds and feeds for increased productivity.
- Ideal for deep-hole drilling in a wide range of materials.

Technical Information
Operating Parameters

Material	Hardness	Speeds (SFM)		Feed Rate (IPR) for drill diameter					
		Bright		.0625"	.1250"	.2500"	.5000"	.7500"	1.0000"
low carbon steel, annealed	85-125 Bhn	85-150	low	.0005	.0010	.0020	.0040	.0050	.0060
			high	.0015	.0030	.0050	.0090	.0100	.0120
medium carbon steel	275-425 Bhn	65-120	low	.0005	.0010	.0020	.0030	.0040	.0040
			high	.0010	.0020	.0040	.0080	.0900	.0100
hardened steel	48-52 Rc C	30-90	low	.0005	.0010	.0020	.0030	.0040	.0040
			high	.0010	.0030	.0030	.0050	.0060	.0070
stainless steel (soft)	135-275 Bhn	50-150	low	.0005	.0005	.0020	.0040	.0050	.0060
			high	.0010	.0030	.0060	.0060	.0080	.0100
stainless steel (hard)	275-425 Bhn	30-90	low	.0005	.0005	.0010	.0015	.0020	.0025
			high	.0010	.0020	.0030	.0040	.0060	.0070
cast iron (soft)	120-220 Bhn	100-300	low	.0010	.0020	.0040	.0050	.0070	.0090
			high	.0020	.0040	.0080	.0100	.0120	.0140
cast iron (hard)	220-320 Bhn	60-200	low	.0015	.0010	.0020	.0030	.0040	.0050
			high	.0020	.0030	.0040	.0070	.0080	.0100
ductile iron		70-250	low	.0010	.0020	.0030	.0050	.0060	.0070
			high	.0020	.0040	.0060	.0080	.0090	.0150
malleable iron		80-250	low	.0010	.0020	.0030	.0050	.0060	.0070
			high	.0020	.0050	.0060	.0120	.0140	.0150
high-temp alloys, nickel-based		15-20	low	.0005	.0005	.0010	.0015	.0020	.0025
			high	.0010	.0030	.0040	.0050	.0600	.0070
monel, high nickel steels		15-20	low	.0005	.0005	.0010	.0015	.0020	.0025
			high	.0010	.0020	.0030	.0040	.0050	.0060
titanium (soft)		60-200	low	.0005	.0020	.0040	.0050	.0060	.0070
			high	.0010	.0030	.0060	.0060	.0080	.0100
titanium (hard)		45-200	low	.0005	.0010	.0020	.0040	.0040	.0050
			high	.0020	.0040	.0070	.0090	.0100	.0120
refractory alloys		50-200	low	.0005	.0005	.0020	.0040	.0050	.0050
			high	.0010	.0030	.0060	.0100	.0120	.0120
aluminum, aluminum alloys		150-400	low	.0010	.0020	.0030	.0050	-	-
			high	.0020	.0040	.0070	.0130	-	-
brass, bronze		100-300	low	.0005	.0010	.0020	.0040	-	-
			high	.0015	.0030	.0040	.0100	-	-
copper, copper alloys		150-400	low	.0010	.0030	.0050	.0060	-	-
			high	.0030	.0050	.0120	.0140	-	-
magnesium, magnesium alloys		200-650	low	.0015	.0030	.0050	.0080	-	-
			high	.0030	.0070	.0120	.0150	-	-
plastics, glass filled		150-300	low	.0010	.0020	.0030	.0050	-	-
			high	.0020	.0040	.0060	.0120	-	-
plastics		250-600	low	.0015	.0030	.0040	.0060	-	-
			high	.0030	.0050	.0120	.0160	-	-

Higher feed and speed values should be favored for softer materials; lower feed and speed values should be used for harder materials. The above recommendations are for hole depths up to 2 drill diameters.

When hole depths run 3 to 6 times diameters, speeds should be reduced 10% to 35% respectively, and feeds should be reduced 10% to 20% respectively.

TECHNICAL

Drill Cutting Speeds

Technical Information

TECHNICAL

High Speed Steel

Fractional

Drill Size Frac / Dec	Feet per Minute														
	10'	20'	30'	40'	50'	60'	70'	80'	90'	100'	110'	120'	130'	140'	150'
1/16 .0625	611	1222	1833	2445	3056	3667	4278	4889	5500	6111	6722	7334	7945	8556	9167
1/8 .1250	306	611	917	1222	1528	1833	2139	2445	2750	3056	3361	3667	3973	4278	4584
3/16 .1875	204	407	611	815	1019	1222	1426	1630	1833	2037	2241	2445	2648	2852	3056
1/4 .2500	153	306	458	611	764	917	1070	1222	1375	1528	1681	1833	1986	2139	2292
5/16 .3125	122	244	367	489	611	733	856	978	1100	1222	1345	1467	1589	1711	1833
3/8 .3750	102	204	306	407	509	611	713	815	917	1019	1120	1222	1324	1426	1528
7/16 .4375	87	175	262	349	437	524	611	698	786	873	960	1048	1135	1222	1310
1/2 .5000	76	153	229	306	382	458	535	611	688	764	840	917	993	1070	1146
5/8 .6250	61	122	183	244	306	367	428	489	550	611	672	733	794	856	917
3/4 .7500	51	102	153	203	255	306	357	407	458	509	560	611	662	713	764
7/8 .8750	44	87	131	175	218	262	306	349	393	436	480	524	568	611	655
1 1.0000	38	76	115	153	191	229	267	306	344	382	420	458	497	535	573
1-1/8 1.1250	34	68	102	136	170	204	238	272	306	340	373	407	441	475	509
1-1/4 1.2500	31	61	92	122	153	183	214	244	275	306	336	367	397	428	458
1-3/8 1.3750	28	56	83	111	139	167	194	222	250	278	306	333	361	389	417
1-1/2 1.5000	26	51	76	102	127	153	178	204	229	255	280	306	331	357	382
1-5/8 1.6250	24	47	70	94	117	141	165	188	212	235	259	282	306	329	353
1-3/4 1.7500	22	44	65	87	109	131	153	175	196	218	240	262	284	306	327
1-7/8 1.8750	20	41	61	81	102	122	143	163	183	204	224	244	265	285	306
2 2.0000	19	38	57	76	95	115	134	153	172	191	210	229	248	267	287
2-1/4 2.2500	17	34	51	68	85	102	119	136	153	170	187	204	221	238	255
2-1/2 2.5000	15	31	46	61	76	92	107	122	137	153	168	183	199	214	229
2-3/4 2.7500	14	28	42	56	69	83	97	111	125	139	153	167	181	194	208
3 3.0000	13	25	38	51	64	76	89	102	115	127	140	153	166	178	191

Letter

Drill Size Letter / Dec	Feet per Minute														
	10'	20'	30'	40'	50'	60'	70'	80'	90'	100'	110'	120'	130'	140'	150'
A .2340	163	326	491	654	818	982	1145	1309	1472	1636	1796	1959	2122	2285	2448
B .2380	161	321	482	642	803	963	1124	1284	1445	1605	1765	1926	2086	2247	2407
C .2420	158	316	473	631	789	947	1105	1262	1420	1578	1736	1894	2052	2210	2368
D .2460	155	311	467	622	778	934	1089	1245	1400	1556	1708	1863	2018	2174	2329
E .2500	153	306	458	611	764	917	1070	1222	1375	1528	1681	1834	1986	2139	2292
F .2570	149	297	446	594	743	892	1040	1189	1337	1486	1635	1784	1932	2081	2229
G .2610	146	293	440	585	732	878	1024	1170	1317	1463	1610	1756	1903	2049	2195
H .2660	144	287	430	574	718	862	1005	1149	1292	1436	1580	1723	1867	2010	2154
I .2720	140	281	421	562	702	842	983	1123	1264	1404	1545	1685	1826	1966	2106
J .2770	138	276	414	552	690	827	965	1103	1241	1379	1517	1655	1793	1930	2068
K .2810	136	272	408	544	680	815	951	1087	1223	1359	1495	1631	1767	1903	2039
L .2900	132	263	395	527	659	790	922	1054	1185	1317	1449	1581	1712	1844	1976
M .2950	129	259	389	518	648	777	907	1036	1166	1295	1424	1554	1683	1813	1942
N .3020	126	253	380	506	633	759	886	1012	1139	1265	1391	1518	1644	1771	1897
O .3160	121	242	363	484	605	725	846	967	1088	1209	1330	1450	1571	1692	1813
P .3230	118	237	355	473	592	710	828	946	1065	1183	1301	1419	1537	1657	1774
Q .3320	115	230	345	460	575	690	805	920	1035	1150	1266	1384	1496	1611	1726
R .3390	113	225	338	451	564	676	789	902	1014	1127	1239	1355	1465	1577	1690
S .3480	110	220	329	439	549	659	769	878	988	1098	1207	1317	1427	1537	1646
T .3580	107	213	320	426	533	640	746	853	959	1066	1173	1280	1387	1494	1600
U .3680	104	208	311	415	519	623	727	830	934	1038	1142	1246	1349	1453	1557
V .3770	101	203	304	405	507	608	709	810	912	1013	1114	1219	1317	1418	1520
W .3860	99	198	297	396	495	594	693	792	891	989	1088	1188	1286	1385	1484
X .3970	96	192	289	385	481	576	672	769	865	962	1058	1155	1251	1347	1443
Y .4040	95	189	284	378	473	567	662	756	851	945	1040	1135	1229	1324	1418
Z .4130	92	185	277	370	462	555	647	740	832	925	1017	1110	1202	1295	1387

Technical Information
Drill Cutting Speeds
TECHNICAL
High Speed Steel

Diameter Range (inches)	Normal Feeds (IPR)	Heavy Feed (IPR)
from 1/16 thru 1/8	.001-.002	.002-.004
over 1/8 thru 1/4	.002-.004	.004-.008
over 1/4 thru 1/2	.004-.008	.008-.016
over 1/2 thru 1	.008-.016	.016-.024
over 1	.016-.024	.024-.032

Wire Gage

Drill Size Wire / Dec	Feet per Minute														
	10'	20'	30'	40'	50'	60'	70'	80'	90'	100'	110'	120'	130'	140'	150'
1 .2280	168	335	503	670	838	1005	1173	1340	1508	1675	1843	2010	2179	2346	2513
2 .2210	173	345	518	691	864	1037	1210	1382	1555	1728	1901	2074	2247	2420	2593
3 .213	179	359	538	717	897	1076	1255	1434	1614	1793	1974	2152	2331	2511	2690
4 .2090	183	365	548	731	914	1097	1280	1462	1645	1828	2010	2193	2376	2560	2741
5 .2055	186	372	558	744	930	1115	1301	1487	1673	1859	2045	2230	2416	2602	2788
6 .2040	187	374	562	749	936	1123	1310	1498	1685	1872	2060	2247	2434	2621	2809
7 .2010	190	380	570	760	950	1140	1330	1520	1710	1900	2090	2281	2470	2660	2850
8 .1990	192	384	576	768	960	1151	1343	1535	1727	1919	2111	2303	2495	2687	2879
9 .1960	195	390	585	780	975	1169	1364	1559	1754	1949	2144	2339	2534	2728	2923
10 .1935	197	395	592	790	987	1184	1382	1579	1777	1974	2171	2369	2566	2764	2961
11 .1910	200	400	600	800	1000	1200	1400	1600	1800	2000	2200	2400	2600	2800	3001
12 .1890	202	404	606	808	1010	1213	1415	1617	1819	2021	2223	2425	2627	2829	3032
13 .1850	206	413	620	826	1032	1239	1450	1652	1859	2065	2271	2479	2684	2891	3097
14 .1820	210	420	630	840	1050	1259	1469	1679	1889	2099	2309	2518	2728	2938	3148
15 .1800	213	425	638	851	1064	1276	1489	1702	1914	2127	2334	2546	2759	2971	3183
16 .1770	216	432	647	863	1079	1295	1511	1726	1942	2158	2374	2590	2806	3021	3237
17 .1730	221	442	662	883	1104	1325	1546	1766	1987	2208	2429	2650	2870	3091	3313
18 .1695	226	452	678	904	1130	1356	1582	1808	2034	2260	2479	2704	2930	3155	3380
19 .1660	230	460	690	920	1151	1381	1611	1841	2071	2301	2531	2761	2991	3222	3453
20 .1610	237	475	712	949	1186	1423	1660	1898	2135	2372	2610	2847	3084	3322	3559
21 .1590	240	480	721	961	1201	1441	1681	1922	2162	2402	2644	2883	3123	3363	3604
22 .1570	243	487	730	973	1217	1460	1703	1946	2190	2433	2676	2920	3164	3406	3649
23 .1540	248	496	744	992	1240	1488	1736	1984	2232	2480	2728	2976	3224	3472	3720
24 .1520	251	503	754	1005	1257	1508	1759	2010	2262	2513	2764	3016	3267	3518	3769
25 .1495	256	511	767	1022	1276	1533	1789	2044	2300	2555	2810	3066	3322	3577	3832
26 .1470	260	520	779	1039	1299	1559	1819	2078	2338	2598	2858	3118	3378	3638	3898
27 .1440	265	531	796	1061	1327	1592	1857	2122	2388	2653	2919	3183	3448	3714	3979
28 .1405	272	544	816	1088	1360	1631	1903	2175	2447	2719	2990	3262	3534	3806	4078
29 .1360	281	562	843	1124	1405	1685	1966	2247	2528	2809	3090	33701	3651	3932	4213
30 .1285	297	595	892	1189	1487	1784	2081	2378	2676	2973	3270	3567	3864	4162	4459
31 .1200	318	637	955	1273	1592	1910	2228	2546	2865	3183	3501	3821	4138	4456	4775
32 .1160	329	659	988	1317	1647	1976	2305	2634	2964	3293	3622	3951	4281	4610	4939
33 .1130	338	676	1014	1352	1690	2028	2366	2704	3042	3380	3718	4056	4394	4732	5070
34 .1110	344	688	1032	1376	1721	2065	2409	2753	3097	3442	3785	4129	4474	4818	5162
35 .1100	347	694	1042	1389	1736	2083	2430	2778	3125	3472	3821	4167	4514	4861	5209
36 .1065	359	717	1076	1435	1794	2152	2511	2870	3228	3587	3945	4304	4663	5021	5380
37 .1040	367	735	1102	1469	1837	2204	2571	2938	3306	3673	4040	4407	4775	5142	5509
38 .1015	376	753	1129	1505	1882	2258	2634	3010	3387	3763	4140	4516	4892	5269	5645

continued on next page

Wire Gage (continued)

TECHNICAL

High Speed Steel

Drill Size Wire / Dec	Feet per Minute														
	10'	20'	30'	40'	50'	60'	70'	80'	90'	100'	110'	120'	130'	140'	150'
39 .0995	384	768	1152	1536	1920	2303	2687	3071	3455	3839	4222	4607	4991	5374	5758
40 .0980	390	780	1169	1559	1949	2339	2729	3118	3508	3898	4287	4677	5067	5457	5846
41 .0960	398	796	1194	1592	1990	2387	2785	3183	3581	3979	4377	4775	5172	5570	5968
42 .0935	408	817	1226	1634	2043	2451	2860	3268	3677	4085	4494	4902	5311	5719	6128
43 .0890	429	858	1288	1717	2146	2575	3004	3434	3863	4292	4721	5150	5579	6008	6438
44 .0860	444	888	1333	1777	2221	2665	3109	3554	3999	4442	4886	5330	5774	6218	6662
45 .0820	466	932	1397	1863	2329	2795	3261	3726	4192	4658	5124	5590	6056	6522	6987
46 .0810	472	943	1415	1886	2358	2830	3301	3773	4244	4716	5187	5659	6130	6602	7074
47 .0785	487	973	1460	1946	2433	2920	3406	3893	4379	4866	5352	5839	6326	6812	7299
48 .0760	503	1005	1508	2010	2513	3016	3518	4021	4523	5026	5528	6031	6534	7036	7539
49 .0730	523	1047	1570	2093	2617	3140	3663	4186	4710	5233	5756	6279	6808	7326	7849
50 .0700	546	1091	1637	2183	2729	3274	3820	4366	4911	5457	6002	6548	7094	7640	8185
51 .0670	570	1140	1710	2280	2851	3421	3991	4561	5131	5701	6271	6841	7413	798	8552
52 .0635	602	1203	1805	2406	3008	3609	4211	4812	5414	6015	6619	7218	7820	8421	9023
53 .0595	641	1283	1924	2566	3207	3848	4490	5131	5773	6414	7062	7704	8346	8988	9630
54 .0550	694	1389	2084	2778	3473	4167	4862	5556	6251	6945	7639	8334	9028	9723	10417
55 .0520	735	1469	2204	2938	3673	4408	5142	5877	6611	7346	8080	8815	9549	10284	11028
56 .0465	821	1643	2465	3286	4108	4929	5751	6572	7394	8215	9036	9857	10678	11500	12322
57 .0430	888	1777	2671	3561	4452	5342	6232	7122	8013	8903	9791	10680	11569	12458	13347
58 .0420	910	1819	2729	3637	4547	5456	6367	7275	8186	9095	10004	10913	11823	12732	13642
59 .0410	932	1863	2795	3726	4658	5590	6521	7453	8388	9316	10248	11180	12111	13043	13975
60 .0400	955	1910	2865	3820	4775	5729	6684	7639	8594	9549	10504	11459	12414	13369	14324
61 .0390	979	1959	2938	3918	4897	5876	6856	7835	8815	9794	10774	11753	12732	13712	14691
62 .0380	1005	2010	3015	4020	5025	6030	7035	8040	9045	10050	11057	12060	13068	14073	15078
63 .0370	1032	2064	3096	4128	5160	6192	7224	8256	9288	10320	11366	12398	13421	14453	15485
64 .0360	1061	2122	3183	4244	5305	6366	7427	8488	9549	10610	11671	12732	13793	14854	15915
65 .0350	1091	2182	3273	4364	5455	6546	7637	8728	9819	10910	12005	13096	14187	15279	16370
66 .0330	1158	2316	3474	4632	5790	6948	8106	9264	10422	11580	12732	13890	15047	16205	17362
67 .0320	1194	2388	3582	4776	5970	7164	8358	9552	10746	11940	13130	14324	15517	16712	17905
68 .0310	1232	2465	3696	4928	6160	7392	8624	9856	11088	12320	13554	14786	16018	17250	18482
69 .0292	1308	2616	3918	5224	6530	7836	9142	10448	11754	13060	14366	15672	16978	18284	19590
70 .0280	1364	2729	4091	5456	6820	8184	9548	10912	12276	13640	15006	16370	17734	19099	20463
71 .0260	1469	2938	4419	5892	7365	8838	10311	11784	13257	14730	16160	17629	19099	20568	22037
72 .0250	1528	3056	4584	6112	7640	9168	10696	12224	13752	15280	16807	18335	19863	21390	22918
73 .0240	1592	3183	4776	6368	7960	9552	11144	12736	14328	15920	17507	19099	20690	22282	23873
74 .0225	1698	3396	5106	6808	8510	10212	11914	13616	15318	17020	18674	20372	22069	23767	25465
75 .0210	1819	3638	5457	7276	9095	10914	12733	14552	16371	18190	20008	21827	23646	25465	27284
76 .0200	1910	3820	5730	7640	9550	11460	13370	15280	17190	19100	21008	22918	24828	26738	28648
77 .0180	2122	4244	6366	8488	10610	12732	14854	16976	19098	21220	23343	25465	27587	29709	31831
78 .0160	2388	4775	7161	9548	11935	14322	16709	19096	21483	23870	26260	28648	31035	33422	35810
79 .0145	2634	5269	7902	10536	13170	15804	18438	21072	23706	26340	28988	31611	34246	36880	39514
80 .0135	2830	5659	8490	11320	14150	16980	19810	22640	25470	28300	31123	33953	36782	39612	42441

Technical Information

Dimensional Specs

Inch Drill Sizes

Conversion formulas:

Inch = mm x .03937

Metric = inch x 25.4

Drill Sizes	Decimal Equiv.	Screw Machine Length				Jobbers Length				Taper Length			
		flute length		overall length		flute length		overall length		flute length		overall length	
		fraction	decimal	fraction	decimal	fraction	decimal	fraction	decimal	fraction	decimal	fraction	decimal
1/64	.0156	—	—	—	—	3/16	.1875	3/4	.7500	5/16	.3125	1-1/2	1.5000
80	.0135	—	—	—	—	1/8	.1250	3/4	.7500	5/16	.3125	1-1/2	1.5000
79	.0145	—	—	—	—	1/8	.1250	3/4	.7500	5/16	.3125	1-1/2	1.5000
78	.0160	—	—	—	—	3/16	.1875	7/8	.8750	5/16	.3125	1-1/2	1.5000
77	.0180	—	—	—	—	3/16	.1875	7/8	.8750	5/16	.3125	1-1/2	1.5000
76	.0200	—	—	—	—	3/16	.1875	7/8	.8750	5/16	.3125	1-1/2	1.5000
75	.0210	—	—	—	—	1/4	.2500	1	1.0000	5/16	.3125	1-1/2	1.5000
74	.0225	—	—	—	—	1/4	.2500	1	1.0000	5/16	.3125	1-1/2	1.5000
73	.0240	—	—	—	—	5/16	.3125	1-1/8	1.1250	5/16	.3125	1-1/2	1.5000
72	.0250	—	—	—	—	5/16	.3125	1-1/8	1.1250	5/16	.3125	1-1/2	1.5000
71	.0260	—	—	—	—	3/8	.3750	1-1/4	1.2500	3/4	.7500	2	2.0000
70	.0280	—	—	—	—	3/8	.3750	1-1/4	1.2500	3/4	.7500	2	2.0000
69	.0292	—	—	—	—	1/2	.5000	1-3/8	1.3750	3/4	.7500	2	2.0000
68	.0310	—	—	—	—	1/2	.5000	1-3/8	1.3750	3/4	.7500	2	2.0000
1/32	.0312	1/2	.5000	1-3/8	1.3750	1/2	.5000	1-3/8	1.3750	3/4	.7500	2	2.0000
67	.0320	—	—	—	—	1/2	.5000	1-3/8	1.3750	3/4	.7500	2	2.0000
66	.0330	—	—	—	—	1/2	.5000	1-3/8	1.3750	3/4	.7500	2	2.0000
65	.0350	—	—	—	—	5/8	.6250	1-1/2	1.5000	3/4	.7500	2	2.0000
64	.0360	—	—	—	—	5/8	.6250	1-1/2	1.5000	3/4	.7500	2	2.0000
63	.0370	—	—	—	—	5/8	.6250	1-1/2	1.5000	3/4	.7500	2	2.0000
62	.0380	—	—	—	—	5/8	.6250	1-1/2	1.5000	3/4	.7500	2	2.0000
61	.0390	—	—	—	—	11/16	.6875	1-5/8	1.6250	1-1/8	1.1250	2-1/4	2.2500
60	.0400	1/2	.5000	1-3/8	1.3750	11/16	.6875	1-5/8	1.6250	1-1/8	1.1250	2-1/4	2.2500
59	.0410	1/2	.5000	1-3/8	1.3750	11/16	.6875	1-5/8	1.6250	1-1/8	1.1250	2-1/4	2.2500
58	.0420	1/2	.5000	1-3/8	1.3750	11/16	.6875	1-5/8	1.6250	1-1/8	1.1250	2-1/4	2.2500
57	.0430	1/2	.5000	1-3/8	1.3750	3/4	.7500	1-3/4	1.7500	1-1/8	1.1250	2-1/4	2.2500
56	.0465	1/2	.5000	1-3/8	1.3750	3/4	.7500	1-3/4	1.7500	1-1/8	1.1250	2-1/4	2.2500
3/64	.0469	1/2	.5000	1-3/8	1.3750	3/4	.7500	1-3/4	1.7500	1-1/8	1.1250	2-1/4	2.2500
55	.0520	5/8	.6250	1-5/8	1.6250	7/8	.8750	1-7/8	1.8750	1-3/4	1.7500	3	3.0000
54	.0550	5/8	.6250	1-5/8	1.6250	7/8	.8750	1-7/8	1.8750	1-3/4	1.7500	3	3.0000
53	.0595	5/8	.6250	1-5/8	1.6250	7/8	.8750	1-7/8	1.8750	1-3/4	1.7500	3	3.0000
1/16	.0625	5/8	.6250	1-5/8	1.6250	7/8	.8750	1-7/8	1.8750	1-3/4	1.7500	3	3.0000
52	.0635	11/16	.6875	1-11/16	1.6875	7/8	.8750	1-7/8	1.8750	2	2.0000	3-3/4	3.7500
51	.0670	11/16	.6875	1-11/16	1.6875	1	1.0000	2	2.0000	2	2.0000	3-3/4	3.7500
50	.0700	11/16	.6875	1-11/16	1.6875	1	1.0000	2	2.0000	2	2.0000	3-3/4	3.7500
49	.0730	11/16	.6875	1-11/16	1.6875	1	1.0000	2	2.0000	2	2.0000	3-3/4	3.7500
48	.0760	11/16	.6875	1-11/16	1.6875	1	1.0000	2	2.0000	2	2.0000	3-3/4	3.7500
5/64	.0781	11/16	.6875	1-11/16	1.6875	1	1.0000	2	2.0000	2	2.0000	3-3/4	3.7500
47	.0785	3/4	.7500	1-3/4	1.7500	1	1.0000	2	2.0000	2-1/4	2.2500	4-1/4	4.2500
46	.0810	3/4	.7500	1-3/4	1.7500	1-1/8	1.1250	2-1/8	2.1250	2-1/4	2.2500	4-1/4	4.2500
45	.0820	3/4	.7500	1-3/4	1.7500	1-1/8	1.1250	2-1/8	2.1250	2-1/4	2.2500	4-1/4	4.2500
44	.0860	3/4	.7500	1-3/4	1.7500	1-1/8	1.1250	2-1/8	2.1250	2-1/4	2.2500	4-1/4	4.2500
43	.0890	3/4	.7500	1-3/4	1.7500	1-1/4	1.2500	2-1/4	2.2500	2-1/4	2.2500	4-1/4	4.2500
42	.0935	3/4	.7500	1-3/4	1.7500	1-1/4	1.2500	2-1/4	2.2500	2-1/4	2.2500	4-1/4	4.2500
3/32	.0938	3/4	.7500	1-3/4	1.7500	1-1/4	1.2500	2-1/4	2.2500	2-1/4	2.2500	4-1/4	4.2500
41	.0960	13/16	.8125	1-13/16	1.8125	1-3/8	1.3750	2-3/8	2.3750	2-1/2	2.5000	4-5/8	4.6250
40	.0980	13/16	.8125	1-13/16	1.8125	1-3/8	1.3750	2-3/8	2.3750	2-1/2	2.5000	4-5/8	4.6250
39	.0995	13/16	.8125	1-13/16	1.8125	1-3/8	1.3750	2-3/8	2.3750	2-1/2	2.5000	4-5/8	4.6250
38	.1015	13/16	.8125	1-13/16	1.8125	1-7/16	1.4375	2-1/2	2.5000	2-1/2	2.5000	4-5/8	4.6250
37	.1040	13/16	.8125	1-13/16	1.8125	1-7/16	1.4375	2-1/2	2.5000	2-1/2	2.5000	4-5/8	4.6250
36	.1065	13/16	.8125	1-13/16	1.8125	1-7/16	1.4375	2-1/2	2.5000	2-1/2	2.5000	4-5/8	4.6250
7/64	.1094	13/16	.8125	1-13/16	1.8125	1-1/2	1.5000	2-5/8	2.6250	2-1/2	2.5000	4-5/8	4.6250
35	.1100	7/8	.8750	1-7/8	1.8750	1-1/2	1.5000	2-5/8	2.6250	2-3/4	2.7500	5-1/8	5.1250
34	.1110	7/8	.8750	1-7/8	1.8750	1-1/2	1.5000	2-5/8	2.6250	2-3/4	2.7500	5-1/8	5.1250
33	.1130	7/8	.8750	1-7/8	1.8750	1-1/2	1.5000	2-5/8	2.6250	2-3/4	2.7500	5-1/8	5.1250
32	.1160	7/8	.8750	1-7/8	1.8750	1-5/8	1.6250	2-3/4	2.7500	2-3/4	2.7500	5-1/8	5.1250

TECHNICAL
 High Speed Steel

continued on next page

Conversion formulas:
 Inch = mm x .03937
 Metric = inch x 25.4

Inch Drill Sizes (continued)

TECHNICAL

High Speed Steel

Drill Sizes	Decimal Equiv.	Screw Machine Length				Jobbers Length				Taper Length			
		flute length		overall length		flute length		overall length		flute length		overall length	
		fraction	decimal	fraction	decimal	fraction	decimal	fraction	decimal	fraction	decimal	fraction	decimal
1/8	.1250	7/8	.8750	1-7/8	1.8750	1-5/8	1.6250	2-3/4	2.7500	2-3/4	2.7500	5-1/8	5.1250
30	.1285	15/16	.9375	1-15/16	1.9375	1-5/8	1.6250	2-3/4	2.7500	3	3.0000	5-3/8	5.3750
29	.1360	15/16	.9375	1-15/16	1.9375	1-3/4	1.7500	2-7/8	2.8750	3	3.0000	5-3/8	5.3750
28	.1405	15/16	.9375	1-15/16	1.9375	1-3/4	1.7500	2-7/8	2.8750	3	3.0000	5-3/8	5.3750
9/64	.1406	15/16	.9375	1-15/16	1.9375	1-3/4	1.7500	2-7/8	2.8750	3	3.0000	5-3/8	5.3750
27	.1440	1	1.0000	2-1/16	2.0625	1-7/8	1.8750	3	3.0000	3	3.0000	5-3/8	5.3750
26	.1470	1	1.0000	2-1/16	2.0625	1-7/8	1.8750	3	3.0000	3	3.0000	5-3/8	5.3750
25	.1495	1	1.0000	2-1/16	2.0625	1-7/8	1.8750	3	3.0000	3	3.0000	5-3/8	5.3750
24	.1520	1	1.0000	2-1/16	2.0625	2	2.0000	3-1/8	3.1250	3	3.0000	5-3/8	5.3750
23	.1540	1	1.0000	2-1/16	2.0625	2	2.0000	3-1/8	3.1250	3	3.0000	5-3/8	5.3750
5/32	.1562	1	1.0000	2-1/16	2.0625	2	2.0000	3-1/8	3.1250	3	3.0000	5-3/8	5.3750
22	.1570	1-1/16	1.0625	2-1/8	2.1250	2	2.0000	3-1/8	3.1250	3-3/8	3.3750	5-3/4	5.7500
21	.1590	1-1/16	1.0625	2-1/8	2.1250	2-1/8	2.1250	3-1/4	3.2500	3-3/8	3.3750	5-3/4	5.7500
20	.1610	1-1/16	1.0625	2-1/8	2.1250	2-1/8	2.1250	3-1/4	3.2500	3-3/8	3.3750	5-3/4	5.7500
19	.1660	1-1/16	1.0625	2-1/8	2.1250	2-1/8	2.1250	3-1/4	3.2500	3-3/8	3.3750	5-3/4	5.7500
18	.1695	1-1/16	1.0625	2-1/8	2.1250	2-1/8	2.1250	3-1/4	3.2500	3-3/8	3.3750	5-3/4	5.7500
11/64	.1719	1-1/16	1.0625	2-1/8	2.1250	2-1/8	2.1250	3-1/4	3.2500	3-3/8	3.3750	5-3/4	5.7500
17	.1730	1-1/8	1.2500	2-3/16	2.1875	2-3/16	2.1875	3-3/8	3.3750	3-3/8	3.3750	5-3/4	5.7500
16	.1770	1-1/8	1.2500	2-3/16	2.1875	2-3/16	2.1875	3-3/8	3.3750	3-3/8	3.3750	5-3/4	5.7500
15	.1800	1-1/8	1.2500	2-3/16	2.1875	2-3/16	2.1875	3-3/8	3.3750	3-3/8	3.3750	5-3/4	5.7500
14	.1820	1-1/8	1.2500	2-3/16	2.1875	2-3/16	2.1875	3-3/8	3.3750	3-3/8	3.3750	5-3/4	5.7500
13	.1850	1-1/8	1.2500	2-3/16	2.1875	2-5/16	2.3125	3-1/2	3.5000	3-3/8	3.3750	5-3/4	5.7500
3/16	.1875	1-1/8	1.2500	2-3/16	2.1875	2-5/16	2.3125	3-1/2	3.5000	3-3/8	3.3750	5-3/4	5.7500
12	.1890	1-3/16	1.1875	2-1/4	2.2500	2-5/16	2.3125	3-1/2	3.5000	3-5/8	3.6250	6	6.0000
11	.1910	1-3/16	1.1875	2-1/4	2.2500	2-5/16	2.3125	3-1/2	3.5000	3-5/8	3.6250	6	6.0000
10	.1935	1-3/16	1.1875	2-1/4	2.2500	2-7/16	2.4375	3-5/8	3.6250	3-5/8	3.6250	6	6.0000
9	.1960	1-3/16	1.1875	2-1/4	2.2500	2-7/16	2.4375	3-5/8	3.6250	3-5/8	3.6250	6	6.0000
8	.1990	1-3/16	1.1875	2-1/4	2.2500	2-7/16	2.4375	3-5/8	3.6250	3-5/8	3.6250	6	6.0000
7	.2010	1-3/16	1.1875	2-1/4	2.2500	2-7/16	2.4375	3-5/8	3.6250	3-5/8	3.6250	6	6.0000
13/64	.2031	1-3/16	1.1875	2-1/4	2.2500	2-7/16	2.4375	3-5/8	3.6250	3-5/8	3.6250	6	6.0000
6	.2040	1-1/4	1.2500	2-3/8	2.3750	2-1/2	2.5000	3-3/4	3.7500	3-5/8	3.6250	6	6.0000
5	.2055	1-1/4	1.2500	2-3/8	2.3750	2-1/2	2.5000	3-3/4	3.7500	3-5/8	3.6250	6	6.0000
4	.2090	1-1/4	1.2500	2-3/8	2.3750	2-1/2	2.5000	3-3/4	3.7500	3-5/8	3.6250	6	6.0000
3	.2130	1-1/4	1.2500	2-3/8	2.3750	2-1/2	2.5000	3-3/4	3.7500	3-5/8	3.6250	6	6.0000
7/32	.2188	1-1/4	1.2500	2-3/8	2.3750	2-1/2	2.5000	3-3/4	3.7500	3-5/8	3.6250	6	6.0000
2	.2210	1-5/16	1.3125	2-7/16	2.4375	2-5/8	2.6250	3-7/8	3.8750	3-3/4	3.7500	6-1/8	6.1250
1	.2280	1-5/16	1.3125	2-7/16	2.4375	2-5/8	2.6250	3-7/8	3.8750	3-3/4	3.7500	6-1/8	6.1250
A	.2340	1-5/16	1.3125	2-7/16	2.4375	2-5/8	2.6250	3-7/8	3.8750	3-3/4	3.7500	6-1/8	6.1250
15/64	.2344	1-5/16	1.3125	2-7/16	2.4375	2-5/8	2.6250	3-7/8	3.8750	3-3/4	3.7500	6-1/8	6.1250
B	.2380	1-3/8	1.3750	2-1/2	2.5000	2-3/4	2.7500	4	4.0000	3-3/4	3.7500	6-1/8	6.1250
C	.2420	1-3/8	1.3750	2-1/2	2.5000	2-3/4	2.7500	4	4.0000	3-3/4	3.7500	6-1/8	6.1250
D	.2460	1-3/8	1.3750	2-1/2	2.5000	2-3/4	2.7500	4	4.0000	3-3/4	3.7500	6-1/8	6.1250
1/4-E	.2500	1-3/8	1.3750	2-1/2	2.5000	2-3/4	2.7500	4	4.0000	3-3/4	3.7500	6-1/8	6.1250
F	.2570	1-7/16	1.4375	2-5/8	2.6250	2-7/8	2.8750	4-1/8	4.1250	3-3/4	3.7500	6-1/8	6.1250
G	.2610	1-7/16	1.4375	2-5/8	2.6250	2-7/8	2.8750	4-1/8	4.1250	3-3/4	3.7500	6-1/8	6.1250
17/64	.2656	1-7/16	1.4375	2-5/8	2.6250	2-7/8	2.8750	4-1/8	4.1250	3-7/8	3.8750	6-1/4	6.2500
H	.2660	1-1/2	1.5000	2-11/16	2.6875	2-7/8	2.8750	4-1/8	4.1250	3-7/8	3.8750	6-1/4	6.2500
I	.2720	1-1/2	1.5000	2-11/16	2.6875	2-7/8	2.8750	4-1/8	4.1250	3-7/8	3.8750	6-1/4	6.2500
J	.2770	1-1/2	1.5000	2-11/16	2.6875	2-7/8	2.8750	4-1/8	4.1250	3-7/8	3.8750	6-1/4	6.2500
9/32	.2812	1-1/2	1.5000	2-11/16	2.6875	2-15/16	2.9375	4-1/4	4.2500	3-7/8	3.8750	6-1/4	6.2500
K	.2812	1-1/2	1.5000	2-11/16	2.6875	2-15/16	2.9375	4-1/4	4.2500	3-7/8	3.8750	6-1/4	6.2500
L	.2900	1-9/16	1.5625	2-3/4	2.7500	2-15/16	2.9375	4-1/4	4.2500	3-7/8	3.8750	6-1/4	6.2500
M	.2950	1-9/16	1.5625	2-3/4	2.7500	3-1/16	3.0625	4-3/8	4.3750	4	4.0000	6-3/8	6.3750
19/64	.2969	1-9/16	1.5625	2-3/4	2.7500	3-1/16	3.0625	4-3/8	4.3750	4	4.0000	6-3/8	6.3750
N	.3020	1-5/8	1.6250	2-13/16	2.8125	3-1/16	3.0625	4-3/8	4.3750	4	4.0000	6-3/8	6.3750
5/16	.3125	1-5/8	1.6250	2-13/16	2.8125	3-3/16	3.1875	4-1/2	4.5000	4	4.0000	6-3/8	6.3750

continued on next page

Technical Information

Dimensional Specs

Conversion formulas:

Inch = mm x .03937

Metric = inch x 25.4

Inch Drill Sizes (continued)
TECHNICAL
High Speed Steel

Drill Sizes	Decimal Equiv.	Screw Machine Length				Jobbers Length				Taper Length			
		flute length		overall length		flute length		overall length		flute length		overall length	
		fraction	decimal	fraction	decimal	fraction	decimal	fraction	decimal	fraction	decimal	fraction	decimal
O	.3160	1-11/16	1.6875	2-15/16	2.9375	3-3/16	3.1875	4-1/2	4.5000	4	4.0000	6-3/8	6.3750
P	.3230	1-11/16	1.6875	2-15/16	2.9375	3-5/16	3.1875	4-5/8	4.6250	4	4.0000	6-3/8	6.3750
21/64	.3281	1-11/16	1.6875	2-15/16	2.9375	3-5/16	3.1875	4-5/8	4.6250	4-1/8	4.1250	6-1/2	6.5000
Q	.3320	1-11/16	1.6875	3	3.0000	3-7/16	3.4375	4-3/4	4.7500	4-1/8	4.1250	6-1/2	6.5000
R	.3390	1-11/16	1.6875	3	3.0000	3-7/16	3.4375	4-3/4	4.7500	4-1/8	4.1250	6-1/2	6.5000
11/32	.3438	1-11/16	1.6875	3	3.0000	3-7/16	3.4375	4-3/4	4.7500	4-1/8	4.1250	6-1/2	6.5000
S	.3480	1-3/4	1.7500	3-1/16	3.0625	3-1/2	3.5000	4-7/8	4.8750	4-1/4	4.2500	6-3/4	6.7500
T	.3580	1-3/4	1.7500	3-1/16	3.0625	3-1/2	3.5000	4-7/8	4.8750	4-1/4	4.2500	6-3/4	6.7500
23/64	.3594	1-3/4	1.7500	3-1/16	3.0625	3-1/2	3.5000	4-7/8	4.8750	4-1/4	4.2500	6-3/4	6.7500
U	.3680	1-13/16	1.8125	3-1/8	3.1250	3-5/8	3.6250	5	5.0000	4-1/4	4.2500	6-3/4	6.7500
3/8	.3750	1-13/16	1.8125	3-1/8	3.1250	3-5/8	3.6250	5	5.0000	4-1/4	4.2500	6-3/4	6.7500
V	.3770	1-7/8	1.8750	3-1/4	3.2500	3-5/8	3.6250	5	5.0000	4-1/4	4.2500	6-3/4	6.7500
W	.3860	1-7/8	1.8750	3-1/4	3.2500	3-3/4	3.7500	5-1/8	5.1250	4-1/4	4.2500	6-3/4	6.7500
25/64	.3906	1-7/8	1.8750	3-1/4	3.2500	3-3/4	3.7500	5-1/8	5.1250	4-3/8	4.3750	7	7.0000
X	.3970	1-15/16	1.9375	3-5/16	3.3125	3-3/4	3.7500	5-1/8	5.1250	4-3/8	4.3750	7	7.0000
Y	.4040	1-15/16	1.9375	3-5/16	3.3125	3-7/8	3.8750	5-1/4	5.2500	4-3/8	4.3750	7	7.0000
13/32	.4062	1-15/16	1.9375	3-5/16	3.3125	3-7/8	3.8750	5-1/4	5.2500	4-3/8	4.3750	7	7.0000
Z	.4130	2	2.0000	3-3/8	3.3750	3-7/8	3.8750	5-1/4	5.2500	4-5/8	4.6250	7-1/4	7.2500
27/64	.4219	2	2.0000	3-3/8	3.3750	3-15/16	3.9375	5-3/8	5.3750	4-5/8	4.6250	7-1/4	7.2500
7/16	.4375	2-1/16	2.0625	3-7/16	3.4375	4-1/16	4.0625	5-1/2	5.5000	4-5/8	4.6250	7-1/4	7.2500
29/64	.4531	2-1/8	2.1250	3-9/16	3.5625	4-3/16	4.1875	5-5/8	5.6250	4-3/4	4.7500	7-1/2	7.5000
15/32	.4688	2-1/8	2.1250	3-5/8	3.6250	4-5/16	4.3125	5-3/4	5.7500	4-3/4	4.7500	7-1/2	7.5000
31/64	.4844	2-3/16	2.1875	3-11/16	3.6875	4-3/8	4.3750	5-7/8	5.8750	4-3/4	4.7500	7-3/4	7.7500
1/2	.5000	2-1/4	2.2500	3-3/4	3.7500	4-1/2	4.5000	6	6.0000	4-3/4	4.7500	7-3/4	7.7500
33/64	.5156	2-3/8	2.3750	3-7/8	3.8750	4-13/16	4.8125	6-5/8	6.6250	4-3/4	4.7500	8	8.0000
17/32	.5312	2-3/8	2.3750	3-7/8	3.8750	4-13/16	4.8125	6-5/8	6.6250	4-3/4	4.7500	8	8.0000
35/64	.5469	2-1/2	2.5000	4	4.0000	4-13/16	4.8125	6-5/8	6.6250	4-7/8	4.8750	8-1/4	8.2500
9/16	.5625	2-1/2	2.5000	4	4.0000	4-13/16	4.8125	6-5/8	6.6250	4-7/8	4.8750	8-1/4	8.2500
37/64	.5781	2-5/8	2.6250	4-1/8	4.1250	4-13/16	4.8125	6-5/8	6.6250	4-7/8	4.8750	8-3/4	8.7500
19/32	.5938	2-5/8	2.6250	4-1/8	4.1250	5-3/16	5.1875	7-1/8	7.1250	4-7/8	4.8750	8-3/4	8.7500
39/64	.6094	2-3/4	2.7500	4-1/4	4.2500	5-3/16	5.1875	7-1/8	7.1250	4-7/8	4.8750	8-3/4	8.7500
5/8	.6250	2-3/4	2.7500	4-1/4	4.2500	5-3/16	5.1875	7-1/8	7.1250	4-7/8	4.8750	8-3/4	8.7500
41/64	.6406	2-7/8	2.8750	4-1/2	4.5000	5-3/16	5.1875	7-1/8	7.1250	5-1/8	5.1250	9	9.0000
21/32	.6562	2-7/8	2.8750	4-1/2	4.5000	5-3/16	5.1875	7-1/8	7.1250	5-1/8	5.1250	9	9.0000
43/64	.6719	2-7/8	2.8750	4-5/8	4.6250	5-5/8	5.6250	7-5/8	7.6250	5-3/8	5.3750	9-1/4	9.2500
11/16	.6875	2-7/8	2.8750	4-5/8	4.6250	5-5/8	5.6250	7-5/8	7.6250	5-3/8	5.3750	9-1/4	9.2500
45/64	.7031	3	3.0000	4-3/4	4.7500	—	—	—	—	5-5/8	5.6250	9-1/2	9.5000
23/32	.7188	3	3.0000	4-3/4	4.7500	—	—	—	—	5-5/8	5.6250	9-1/2	9.5000
47/64	.7344	3-1/8	3.1250	5	5.0000	—	—	—	—	5-7/8	5.8750	9-3/4	9.7500
3/4	.7500	3-1/8	3.1250	5	5.0000	—	—	—	—	5-7/8	5.8750	9-3/4	9.7500
49/64	.7656	3-1/4	3.2500	5-1/8	5.1250	—	—	—	—	6	6.0000	9-7/8	9.8750
25/32	.7812	3-1/4	3.2500	5-1/8	5.1250	—	—	—	—	6	6.0000	9-7/8	9.8750
51/64	.7969	3-3/8	3.3750	5-1/4	5.2500	—	—	—	—	6-1/8	6.1250	10	10.0000
13/16	.8125	3-3/8	3.3750	5-1/4	5.2500	—	—	—	—	6-1/8	6.1250	10	10.0000
53/64	.8281	3-1/2	3.5000	5-3/8	5.3750	—	—	—	—	6-1/8	6.1250	10	10.0000
27/32	.8438	3-1/2	3.5000	5-3/8	5.3750	—	—	—	—	6-1/8	6.1250	10	10.0000
55/64	.8594	3-1/2	3.5000	5-1/2	5.5000	—	—	—	—	6-1/8	6.1250	10	10.0000
7/8	.8750	3-1/2	3.5000	5-1/2	5.5000	—	—	—	—	6-1/8	6.1250	10	10.0000
57/64	.8906	3-5/8	3.6250	5-5/8	5.6250	—	—	—	—	6-1/8	6.1250	10	10.0000
29/32	.9062	3-5/8	3.6250	5-5/8	5.6250	—	—	—	—	6-1/8	6.1250	10	10.0000
59/64	.9219	3-3/4	3.7500	5-3/4	5.7500	—	—	—	—	6-1/8	6.1250	10-3/4	10.7500
15/16	.9375	3-3/4	3.7500	5-3/4	5.7500	—	—	—	—	6-1/8	6.1250	10-3/4	10.7500
61/64	.9531	3-7/8	3.8750	5-7/8	5.8750	—	—	—	—	6-3/8	6.3750	11	11.0000
31/32	.9688	3-7/8	3.8750	5-7/8	5.8750	—	—	—	—	6-3/8	6.3750	11	11.0000
63/64	.9844	4	4.0000	6	6.0000	—	—	—	—	6-3/8	6.3750	11	11.0000
1	1.0000	4	4.0000	6	6.0000	—	—	—	—	6-3/8	6.3750	11	11.0000

Conversion formulas:

Inch = mm x .03937

Metric = inch x 25.4

Metric Drill Sizes

TECHNICAL

High Speed Steel

Drill Size (mm)	Decimal Equivalent (in)	Screw Machine Length DIN 1897		Jobbers Length DIN 338		Taper Length DIN 340	
		flute length	overall length	flute length	overall length	flute length	overall length
		mm	mm	mm	mm	mm	mm
0.2	.0079	1.5	19	2.5	19	—	—
0.22	.0087	1.5	19	2.5	19	—	—
0.25	.0098	1.5	19	3	19	—	—
0.28	.0110	1.5	19	3	19	—	—
0.3	.0118	1.5	19	3	19	—	—
0.32	.0126	2	19	4	19	—	—
0.35	.0138	2	19	4	19	—	—
0.38	.0150	2	19	4	19	—	—
0.4	.0157	2.5	19	5	20	—	—
0.42	.0165	2.5	19	5	20	—	—
0.45	.0177	2.5	19	5	20	—	—
0.48	.0189	2.5	19	5	20	—	—
0.5	.0197	3	20	6	22	—	—
0.52	.0205	3	20	6	22	—	—
0.55	.0217	3.5	21	7	24	—	—
0.58	.0228	3.5	21	7	24	—	—
0.6	.0236	3.5	21	7	24	—	—
0.62	.0244	4	22	8	26	—	—
0.65	.0256	4	22	8	26	—	—
0.68	.0268	4.5	23	9	28	—	—
0.7	.0276	4.5	23	9	28	—	—
0.72	.0283	4.5	23	9	28	—	—
0.75	.0295	4.5	23	9	28	—	—
0.78	.0307	5	24	10	30	—	—
0.8	.0315	5	24	10	30	—	—
0.82	.0322	5	24	10	30	—	—
0.85	.0335	5	24	10	30	—	—
0.88	.0346	5.5	25	11	32	—	—
0.9	.0354	5.5	25	11	32	—	—
0.92	.0362	5.5	25	11	32	—	—
0.95	.0374	5.5	25	11	32	—	—
0.98	.0385	6	26	12	34	—	—
1.0	.0394	6	26	12	34	33	56
1.05	.0413	6	26	12	34	—	—
1.1	.0433	7	28	14	36	37	60
1.15	.0453	7	28	14	36	—	—
1.2	.0472	8	30	16	38	41	65
1.25	.0492	8	30	16	38	—	—
1.3	.0512	8	30	16	38	41	65
1.35	.0531	9	32	18	40	—	—
1.4	.0551	9	32	18	40	45	70
1.45	.0571	9	32	18	40	—	—
1.5	.0591	9	32	18	40	45	70
1.55	.0610	10	34	20	43	—	—
1.6	.0630	10	34	20	43	50	76
1.65	.0650	10	34	20	43	—	—
1.7	.0669	10	34	20	43	50	76
1.75	.0689	11	36	22	46	—	—
1.8	.0709	11	36	22	46	53	80
1.85	.0728	11	36	22	46	—	—
1.9	.0748	11	36	22	46	53	80
1.95	.0767	12	38	24	49	—	—
2.0	.0787	12	38	24	49	56	85
2.05	.0807	12	38	24	49	—	—
2.1	.0827	12	38	24	49	56	85
2.15	.0846	13	40	27	53	—	—

continued on next page

Conversion formulas:

Inch = mm x .03937

Metric = inch x 25.4

Metric Drill Sizes (continued)

Drill Size (mm)	Decimal Equivalent (in)	Screw Machine Length DIN 1897		Jobbers Length DIN 338		Taper Length DIN 340	
		flute length	overall length	flute length	overall length	flute length	overall length
		mm	mm	mm	mm	mm	mm
2.2	.0866	13	40	27	53	59	90
2.25	.0886	13	40	27	53	—	—
2.3	.0906	13	40	27	53	59	90
2.35	.0925	13	40	27	53	—	—
2.4	.0945	14	43	30	57	62	95
2.45	.0964	14	43	30	57	—	—
2.5	.0984	14	43	30	57	62	95
2.55	.1003	14	43	30	57	—	—
2.6	.1024	14	43	30	57	62	95
2.65	.1043	14	43	30	57	—	—
2.7	.1062	16	46	33	61	66	100
2.75	.1082	16	46	33	61	—	—
2.8	.1102	16	46	33	61	66	100
2.85	.1122	16	46	33	61	—	—
2.9	.1142	16	46	33	61	66	100
2.95	.1161	16	46	33	61	—	—
3.0	.1181	16	46	33	61	66	100
3.1	.1220	18	49	36	65	69	106
3.2	.1260	18	49	36	65	69	106
3.3	.1299	18	49	36	65	69	106
3.4	.1339	20	52	39	70	73	112
3.5	.1378	20	52	39	70	73	112
3.6	.1417	20	52	39	70	73	112
3.7	.1457	20	52	39	70	73	112
3.8	.1496	22	55	43	75	78	119
3.9	.1535	22	55	43	75	78	119
4.0	.1575	22	55	43	75	78	119
4.1	.1614	22	55	43	75	78	119
4.2	.1654	22	55	43	75	78	119
4.3	.1692	24	58	47	80	82	126
4.4	.1732	24	58	47	80	82	126
4.5	.1772	24	58	47	80	82	126
4.6	.1811	24	58	47	80	82	126
4.7	.1850	24	58	47	80	82	126
4.8	.1890	26	62	52	86	87	132
5.0	.1969	26	62	52	86	87	132
5.1	.2008	26	62	52	86	87	132
5.2	.2047	26	62	52	86	87	132
5.3	.2086	26	62	52	86	87	132
5.4	.2125	28	66	57	93	91	139
5.5	.2165	28	66	57	93	91	139
5.6	.2205	28	66	57	93	91	139
5.7	.2244	28	66	57	93	91	139
5.8	.2283	28	66	57	93	91	139
5.9	.2322	28	66	57	93	91	139
6.0	.2362	28	66	57	93	91	139
6.1	.2401	31	70	63	101	97	148
6.2	.2440	31	70	63	101	97	148
6.3	.2480	31	70	63	101	97	148
6.4	.2520	31	70	63	101	97	148
6.5	.2559	31	70	63	101	97	148
6.6	.2598	31	70	63	101	97	148
6.7	.2638	31	70	63	101	97	148
6.8	.2677	34	74	69	109	102	156
6.9	.2717	34	74	69	109	102	156
7.0	.2756	34	74	69	109	102	156

TECHNICAL
High Speed Steel
continued on next page

Conversion formulas:

Inch = mm x .03937

Metric = inch x 25.4

Metric Drill Sizes (continued)

Drill Size (mm)	Decimal Equivalent (in)	Screw Machine Length DIN 1897		Jobbers Length DIN 338		Taper Length DIN 340	
		flute length	overall length	flute length	overall length	flute length	overall length
		mm	mm	mm	mm	mm	mm
7.1	.2795	34	74	69	109	102	156
7.2	.2835	34	74	69	109	102	156
7.3	.2874	34	74	69	109	102	156
7.4	.2913	34	74	69	109	102	156
7.5	.2953	34	74	69	109	102	156
7.6	.2992	37	79	75	117	109	165
7.7	.3031	37	79	75	117	109	165
7.8	.3070	37	79	75	117	109	165
7.9	.3110	37	79	75	117	109	165
8.0	.3150	37	79	75	117	109	165
8.1	.3189	37	79	75	117	109	165
8.2	.3228	37	79	75	117	109	165
8.3	.3267	37	79	75	117	109	165
8.4	.3307	37	79	75	117	109	165
8.5	.3346	37	79	75	117	109	165
8.6	.3386	40	84	81	125	115	175
8.7	.3425	40	84	81	125	115	175
8.8	.3464	40	84	81	125	115	175
8.9	.3503	40	84	81	125	115	175
9.0	.3543	40	84	81	125	115	175
9.1	.3582	40	84	81	125	115	175
9.2	.3622	40	84	81	125	115	175
9.3	.3661	40	84	81	125	115	175
9.4	.3700	40	84	81	125	115	175
9.5	.3740	40	84	81	125	115	175
9.6	.3779	43	89	87	133	121	184
9.7	.3817	43	89	87	133	121	184
9.8	.3858	43	89	87	133	121	184
9.9	.3897	43	89	87	133	121	184
10.0	.3937	43	89	87	133	121	184
10.1	.3976	43	89	87	133	121	184
10.2	.4016	43	89	87	133	121	184
10.3	.4055	43	89	87	133	121	184
10.4	.4094	43	89	87	133	121	184
10.5	.4134	43	89	87	133	121	184
10.6	.4173	43	89	87	133	121	184
10.7	.4212	47	95	94	142	128	195
10.8	.4252	47	95	94	142	128	195
10.9	.4291	47	95	94	142	128	195
11.0	.4331	47	95	94	142	128	195
11.1	.4370	47	95	94	142	128	195
11.2	.4409	47	95	94	142	128	195
11.3	.4448	47	95	94	142	128	195
11.4	.4488	47	95	94	142	128	195
11.5	.4527	47	95	94	142	128	195
11.6	.4566	47	95	94	142	128	195
11.7	.4606	47	95	94	142	128	195
11.8	.4645	47	95	94	142	128	195
11.9	.4685	51	102	101	151	134	205
12.0	.4724	51	102	101	151	134	205
12.1	.4763	51	102	101	151	134	205
12.2	.4823	51	102	101	151	134	205
12.3	.4842	51	102	101	151	134	205
12.4	.4881	51	102	101	151	134	205
12.5	.4921	51	102	101	151	134	205
12.6	.4960	51	102	101	151	134	205

continued on next page

TECHNICAL

High Speed Steel

Conversion formulas:

Inch = mm x .03937

Metric = inch x 25.4

Metric Drill Sizes (continued)

Drill Size (mm)	Decimal Equivalent (in)	Screw Machine Length DIN 1897		Jobbers Length DIN 338		Taper Length DIN 340	
		flute length mm	overall length mm	flute length mm	overall length mm	flute length mm	overall length mm
12.7	.5000	51	102	101	151	134	205
12.8	.5039	51	102	101	151	134	205
12.9	.5078	51	102	101	151	134	205
13.0	.5118	51	102	101	151	134	205
13.1	.5157	51	102	101	151	134	205
13.2	.5197	51	102	101	151	134	205
13.3	.5236	54	107	108	160	140	214
13.4	.5118	54	107	108	160	140	214
13.5	.5315	54	107	108	160	140	214
13.6	.5354	54	107	108	160	140	214
13.7	.5394	54	107	108	160	140	214
13.8	.5433	54	107	108	160	140	214
13.9	.5472	54	107	108	160	140	214
14.0	.5512	54	107	108	160	140	214
14.25	.5610	56	111	114	169	144	220
14.5	.5709	56	111	114	169	144	220
14.75	.5807	56	111	114	169	144	220
15.0	.5906	56	111	114	169	144	220
15.25	.6004	58	115	120	178	149	227
15.5	.6102	58	115	120	178	149	227
15.75	.6201	58	115	120	178	149	227
16.0	.6299	58	115	120	178	149	227

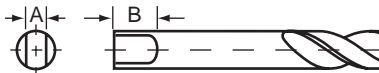
TECHNICAL
High Speed Steel
Shank / Tang

Shank Diameter (inches)		Tang Dimensions (inches)	
from	to	A width	B length
1/8	3/16	.092	9/32
over 3/16	1/4	.120	5/16
over 1/4	5/16	.160	11/32
over 5/16	3/8	.201	3/8
over 3/8	15/32	.241	7/16
over 15/32	9/16	.300	1/2
over 9/16	21/32	.370	9/16
over 21/32	3/4	.440	5/8
over 3/4	7/8	.511	11/16
over 7/8	1	.605	3/4
over 1-3/16	1-3/8	.813	7/8

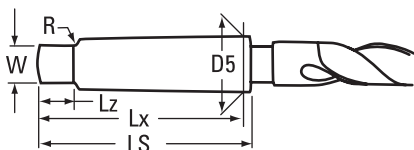
Morse Taper Shank

morse taper shank number	taper per foot	taper per inch	D5 maximum shank dia.	LS length of shank	Lx length of shank to gage line	Lz length of tang	W thickness of tang	R radius
1	.5985	.0498	.475	2.56	2.44	.37	.20	.19
2	.5994	.0499	.700	3.12	2.94	.44	.25	.25
3	.6023	.0501	.938	3.87	3.69	.56	.31	.28
4	.6232	.0519	1.231	4.87	4.62	.62	.47	.31
5	.6315	.0526	1.749	6.12	5.87	.75	.62	.37
6	.6256	.0521	2.494	8.56	8.25	1.12	.75	.50

Straight Shank Chucking Reamer Dimensions

Straight Flute

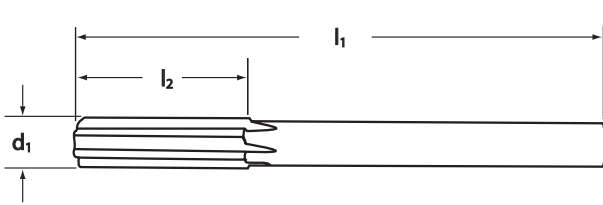

Spiral Flute

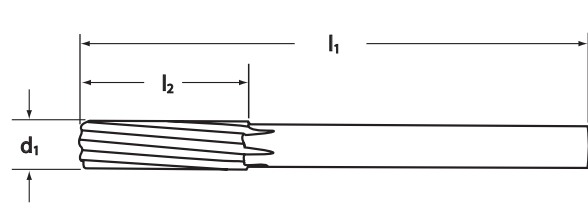

TECHNICAL

High Speed Steel

decimal size range		reamer dia d ₁ (in)		overall length l ₁ (in)	flute length l ₂ (in)	no. of flutes
min	max	max	min			
.0394	.0460	.0390	.0380	2.500	.500	4
.0461	.0515	.0455	.0445	2.500	.500	4
.0516	.0590	.0510	.0500	2.500	.500	4
.0591	.0635	.0585	.0575	2.500	.500	4
.0636	.0665	.0585	.0575	3.000	.750	4
.0666	.0755	.0660	.0650	3.000	.750	4
.0756	.0805	.0720	.0710	3.000	.750	4
.0806	.0855	.0771	.0761	3.000	.750	4
.0856	.0930	.0810	.0800	3.000	.750	4
.0931	.0938	.0880	.0870	3.000	.750	4
.0939	.0955	.0880	.0870	3.500	.875	4
.0956	.1005	.0928	.0918	3.500	.875	4
.1006	.1060	.0950	.0940	3.500	.875	4
.1061	.1105	.1030	.1020	3.500	.875	4
.1106	.1155	.1055	.1045	3.500	.875	4
.1156	.1160	.1120	.1110	3.500	.875	4
.1161	.1225	.1120	.1110	3.500	.875	6
.1226	.1285	.1190	.1180	3.500	.875	6
.1286	.1355	.1190	.1180	4.000	1.000	6
.1356	.1400	.1275	.1265	4.000	1.000	6
.1401	.1465	.1350	.1340	4.000	1.000	6
.1466	.1515	.1430	.1420	4.000	1.000	6
.1516	.1560	.1460	.1450	4.000	1.000	6
.1561	.1570	.1510	.1500	4.000	1.000	6
.1571	.1585	.1510	.1500	4.500	1.125	6
.1586	.1655	.1530	.1520	4.500	1.125	6
.1656	.1715	.1595	.1585	4.500	1.125	6
.1716	.1765	.1645	.1635	4.500	1.125	6
.1766	.1795	.1704	.1694	4.500	1.125	6
.1796	.1845	.1755	.1745	4.500	1.125	6

decimal size range		reamer dia d ₁ (in)		overall length l ₁ (in)	flute length l ₂ (in)	no. of flutes
min	max	max	min			
.1846	.1890	.1805	.1795	4.500	1.125	6
.1891	.1905	.1805	.1795	5.000	1.250	6
.1906	.1955	.1860	.1850	5.000	1.250	6
.1956	.2005	.1895	.1885	5.000	1.250	6
.2006	.2050	.1945	.1935	5.000	1.250	6
.2051	.2125	.2016	.2006	5.000	1.250	6
.2126	.2188	.2075	.2065	5.000	1.250	6
.2189	.2205	.2075	.2065	6.000	1.500	6
.2206	.2335	.2173	.2163	6.000	1.500	6
.2336	.2375	.2265	.2255	6.000	1.500	6
.2376	.2475	.2329	.2319	6.000	1.500	6
.2476	.2530	.2405	.2395	6.000	1.500	6
.2531	.2840	.2485	.2475	6.000	1.500	6
.2841	.3438	.2792	.2782	6.000	1.500	6
.3439	.4062	.3105	.3095	7.000	1.750	6
.4063	.4688	.3730	.3720	7.000	1.750	6
.4689	.5010	.4355	.4345	8.000	2.000	6
.5011	.6000	.4355	.4345	8.000	2.000	8
.6001	.7230	.5620	.5605	9.000	2.250	8
.7231	.8490	.6245	.6230	9.500	2.500	8
.8491	.9740	.7495	.7480	10.000	2.625	8
.9741	1.0000	.8745	.8730	10.500	2.750	8
1.0001	1.0625	.8745	.8730	10.500	2.750	10
1.0626	1.1250	.8745	.8730	11.000	2.875	10
1.1251	1.1875	.9995	.9980	11.000	2.875	10
1.1876	1.3125	.9995	.9980	11.500	3.000	10
1.3126	1.3750	.9995	.9980	12.000	3.250	10
1.3751	1.4375	1.2495	1.2480	12.000	3.250	10
1.4376	1.5000	1.2495	1.2480	12.500	3.500	12

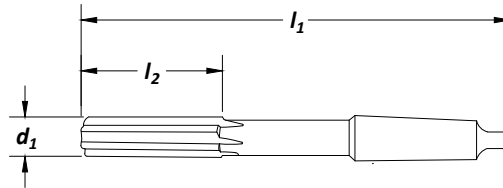
Taper Shank Chucking Reamers - Straight Flute

diameter size range		overall length l_1 (in)	flute length l_2 (in)	morse taper shank number	no. of flutes
min	max				
.1750	.1890	4.500	1.125	1	6
.1891	.2041	5.000	1.250	1	6
.2042	.2188	5.000	1.250	1	6
.2189	.2630	6.000	1.500	1	6
.2531	.2840	6.000	1.500	1	6
.2841	.3135	6.000	1.500	1	6
.3136	.3438	6.000	1.500	1	6
.3439	.3770	7.000	1.750	1	6
.3771	.4062	7.000	1.750	1	6
.4063	.4385	7.000	1.750	1	6
.4386	.4688	7.000	1.750	1	6
.4689	.5010	8.000	2.000	1	6
.5011	.5330	8.000	2.000	1	8
.5331	.5635	8.000	2.000	1	8
.5636	.5938	8.000	2.000	1	8
.5939	.6260	9.000	2.250	2	8
.6261	.6719	9.000	2.250	2	8
.6720	.7230	9.000	2.250	2	8
.7231	.7656	9.500	2.500	2	8
.7657	.8125	9.500	2.500	2	8
.8126	.8490	9.500	2.500	2	8
.8491	.9062	1.000	2.625	2	8
.9063	.9740	1.000	2.625	3	8
.9741	1.0000	1.500	2.750	3	8
1.0001	1.0625	1.500	2.750	3	10
1.0626	1.1250	11.000	2.875	3	10
1.1251	1.1875	11.000	2.875	3	10
1.1876	1.2500	11.500	3.000	4	10
1.2501	1.3125	11.500	3.000	4	10
1.3126	1.3750	12.000	3.250	4	10
1.3751	1.4375	12.000	3.250	4	10
1.4376	1.5000	12.500	3.500	4	12

Reaming Speeds

Speeds for machine reaming may vary considerably depending in part on the material to be reamed, type of machine, and required finish and accuracy. In general most machine reaming is done at about 2/3 the speed used for drilling the same material. Speeds for reaming are shown on pages 128-129.

Reaming Feeds

Feeds for reaming are usually much higher than those used for drilling, often running 200% to 300% of drill feeds. Too low a feed may result in excessive reamer wear. At all times it is necessary that the feed be high enough to permit the reamer to cut rather than to rub or burnish. Too high a feed may tend to reduce the accuracy of the hole and may also lower the quality of the finish. The basic idea is to use as high a feed as possible and still produce the required finish and accuracy.

Stock to be Removed

For the same reason, insufficient stock for reaming may result in a burnishing rather than a cutting action. It is difficult to generalize on this phase as it is tied in closely with type of material, feed, finish required, depth of hole, and chip capacity of the reamer. For machine reaming, 0.010" on a 1/4" hole, 0.015" on a 1/2" hole, up to 0.025" on a 1-1/2" hole, seems a good starting point. For hand reaming, stock allowances are much smaller, partly because of the difficulty in forcing the reamer through greater stock. A common allowance is 0.001" to 0.003".

Alignment

In the ideal reaming job, the spindle, reamer, bushing, and hole to be machined are all in perfect alignment. Any variation from this tends to increase reamer wear and detracts from the accuracy of the hole. Tapered, oversize, or bell-mouthed holes should call for a check of alignment. Sometimes the bad effects of misalignment can be reduced through the use of floating or adjustable holders. Quite often if the user will grind a slight back taper on the reamer it will also be of help in overcoming the effects of misalignment.

Chatter

The presence of chatter while reaming has a very bad effect on reamer life and on the finish in the hole. Chatter may be the result of one of several causes, some of which are listed:

- Excessive speed.
- Too much clearance on reamer.
- Lack of rigidity in jig or machine.
- Insecure holding of work.
- Excessive overhang of reamer or spindle.
- Excessive looseness in floating holder.
- Too light a feed.

Correcting the cause can materially increase both reamer life and the quality of the reamed holes.

Coolant

In reaming, the emphasis is usually on finish, and a coolant is normally chosen for this purpose rather than for cooling. Quite often this means a change from that recommended for drilling as shown on page 2, but in general this list will be found satisfactory.

American National Standard Reamer Taper (Morse Taper) Dimensions

Taper No.	Depth of Hole	
	A <i>Drilled</i>	B <i>Reamed</i>
0*	2-1/16	2-1/32
1	2-3/16	2-5/32
2	3-1/8	2-15/16
3	3-7/8	3-11/16
4	4-7/8	4-5/8
4-1/2	5-1/8	4-5/8
5	6-1/8	5-7/8
6	8-9/16	8-1/4
7	11-5/8	11-1/4

*Size 0 taper shank not listed in American National Standards.

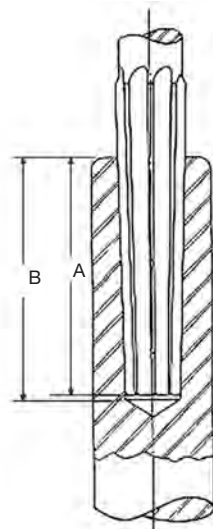

Reamer Stock Removal

Stock removal is dependent on material, feed, and finish required. The stock removal chart below illustrates starting points for various diameters when using machine and chucking reamers.

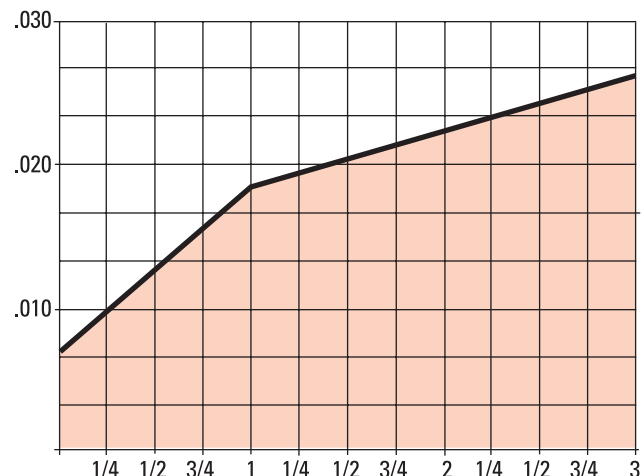

Reamer Diameter Tolerances

Reamer Diameter inches	+	+
	inches	inches
through 1/2	.0001	.0004
over 1/2 through 1	.0001	.0005
over 1	.0002	.0006
	+	-
dowel pin sizes	.0000	(.0002)

Reamer Overall Length and Flute Length Tolerances

Reamer Diameter inches	+	-
	inches	inches
3/64 through 1	.0625	.0625
over 1 through 2	.0938	.0938
over 2 through 3	.1250	.1250

Reamer Lip Height Tolerances

Reamer Diameter inches	Total Indicator Variation inches
through 1/8	.0010
1/8 through 1/4	.0012
over 1/4 through 1/2	.0015
over 1/2 through 1	.0020
over 1 through 3-1/2	.0025

Reamer Straight Shank Diameter Tolerances

Reamer Diameter	+	-
	inches	inches
Tool Style 4001, 4030		
.0390 to .4335	.0000	.0010
.4396 to 1.2495	.0000	.0015
Tool Style 657, 659		
.0781 to .6250	.0010	.0050
Tool Style 650		
.0781 to .6250	.0005	.0020

Reamer Regrinding

In obtaining maximum economy from reamers the same principles apply as in the case of most other cutting tools. One of these principles is not to allow a tool to become too dull. It is best to regrind the chamfer on a reamer long before it exhibits excessive wear or refuses to cut. This sharpening is usually restricted to the entering taper or chamfer. It can be done on almost any tool and cutter grinder. Care must be taken so that each flute is ground exactly even or the tool is apt to cut oversize.

Sharpening the chamfer on a reamer by hand is not recommended as it is practically impossible to keep the cutting edges even.

The following figures show three common types of grinds used on reamers:

In grinding down a reamer to special size it is usually necessary to relieve or clear the lands. No hard or fast rule may be given as to the amount of this clearance but the following table may be of help:

Size of Reamer	Circular Land Width	Primary Clearance
1/4"	.007	14°
1/2"	.009	11°
1"	.013	9°
1-1/2"	.016	7°
2"	.023	7°

Figure A

Ordinary reamer grind for most jobs.

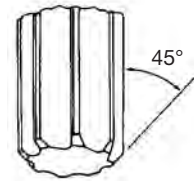
Figure B

Hand reamer grind also used on some machine reamer applications to obtain required finish or tolerance.

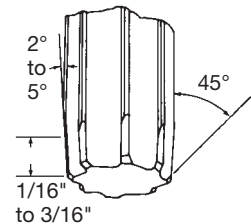
Figure C

Semi-finish reamer grind to straighten out bent or misaligned holes. Corners must be kept sharp.

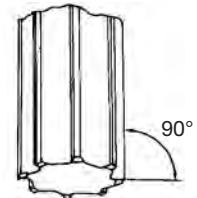
Figure D

A secondary clearance is often ground on reamers as shown in Fig. D. This clearance is only to insure the back of the land being well away from the wall of the reamed hole in order to prevent rubbing.

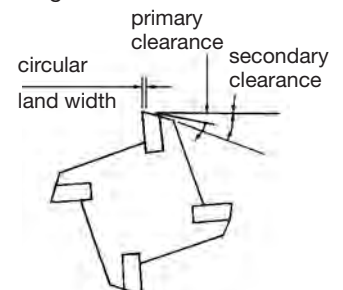

TECHNICAL

High Speed Steel

Fractional Sizes

Drill Size Fraction / Dec	Feet per Minute														
	10'	20'	30'	40'	50'	60'	70'	80'	90'	100'	110'	120'	130'	140'	150'
1/16 .0625	403	807	1210	1614	2017	2420	2823	3227	3663	4033	4437	4840	5244	5647	6050
1/8 .1250	202	403	605	807	1008	1210	1412	1614	1815	2017	2218	2420	2622	2823	3025
3/16 .1875	135	269	403	538	673	807	941	1076	1210	1344	1479	1614	1748	1882	2017
1/4 .2500	101	202	302	403	504	605	706	807	908	1008	1109	1210	1311	1412	1513
5/16 .3125	81	161	242	323	403	484	565	645	726	807	888	968	1049	1129	1210
3/8 .3750	67	135	202	269	336	403	471	538	605	673	739	807	874	941	1008
7/16 .4375	57	116	173	230	288	346	403	461	519	576	634	692	749	807	865
1/2 .5000	50	101	151	202	252	302	353	403	454	504	554	605	655	706	756
5/8 .6250	40	81	121	161	202	242	282	323	363	403	444	484	524	565	605
3/4 .7500	34	67	101	134	168	202	236	269	302	336	370	403	437	471	504
7/8 .8750	29	57	86	116	144	173	202	230	259	288	317	346	375	403	432
1 1.0000	25	50	76	101	126	151	176	202	227	252	277	302	328	353	378
1-1/8 1.1250	22	45	67	90	112	135	157	180	202	224	246	269	291	314	336
1-1/4 1.2500	20	40	61	81	101	121	141	161	182	202	222	242	262	282	302
1-3/8 1.3750	18	37	55	73	92	110	128	147	165	183	202	220	238	257	275
1-1/2 1.5000	17	34	50	67	84	101	117	135	151	168	185	202	218	236	252
1-5/8 1.6250	16	31	46	62	77	93	109	124	140	155	171	186	202	217	233
1-3/4 1.7500	15	29	43	57	72	86	101	116	129	144	158	173	187	202	216
1-7/8 1.8750	13	27	40	53	67	81	94	108	121	135	148	161	175	188	202
2 2.0000	13	25	38	50	63	76	88	101	114	126	139	151	164	176	189
2-1/4 2.2500	11	22	34	45	56	67	79	90	101	112	123	135	146	157	168
2-1/2 2.5000	10	20	30	40	50	61	71	81	90	101	111	121	131	141	151
2-3/4 2.7500	9	18	28	37	46	55	64	73	83	92	101	110	119	128	137
3 3.0000	9	17	25	34	42	50	59	67	76	84	92	101	110	117	126

Letter Sizes

Drill Size Letter / Dec	Feet per Minute														
	10'	20'	30'	40'	50'	60'	70'	80'	90'	100'	110'	120'	130'	140'	150'
A .2340	108	215	324	432	540	648	756	864	972	1080	1185	1293	1401	1508	1616
B .2380	106	212	318	424	530	636	742	847	954	1059	1165	1271	1377	1483	1589
C .2420	104	209	312	416	521	625	729	833	937	1041	1146	1250	1354	1459	1563
D .2460	102	205	308	411	513	616	719	822	924	1027	1127	1230	1332	1435	1537
E .2500	101	202	302	403	504	605	706	807	908	1008	1109	1210	1299	1412	1513
F .2570	98	196	294	392	490	589	686	785	882	981	1079	1177	1275	1373	1471
G .2610	96	193	290	386	483	579	676	772	869	966	1063	1159	1256	1352	1449
H .2660	95	189	284	379	474	569	663	758	853	948	1043	1137	1232	1327	1422
I .2720	92	185	278	371	463	556	649	741	834	927	1020	1112	1205	1298	1390
J .2770	91	182	273	364	455	546	637	728	819	910	1001	1092	1183	1274	1365
K .2810	90	180	269	359	449	538	628	717	807	897	987	1076	1166	1256	1346
L .2900	87	174	261	348	435	521	609	696	782	869	956	1043	1130	1217	1304
M .2950	85	171	257	342	428	513	599	684	770	855	940	1026	1111	1197	1282
N .3020	83	167	251	334	418	501	585	668	752	835	918	1002	1085	1169	1252
O .3160	80	160	240	319	399	479	558	638	718	798	878	957	1037	1117	1197
P .3230	78	156	234	312	391	469	546	624	703	781	859	937	1014	1094	1171
Q .3320	76	152	228	304	380	455	531	607	683	759	836	913	987	1063	1139
R .3390	75	149	223	298	372	446	521	595	669	744	818	894	967	1041	1115
S .3480	73	145	217	290	362	435	508	579	652	725	797	869	942	1014	1086
T .3580	71	141	211	281	352	422	492	563	633	704	774	845	915	986	1056
U .3680	69	137	205	274	343	411	480	548	616	685	754	822	890	959	1028
V .3770	67	134	201	267	335	401	468	535	602	669	735	805	869	936	1003
W .3860	65	131	196	261	327	392	457	523	588	653	718	784	849	914	979
X .3970	63	127	191	254	317	380	444	508	571	635	698	762	826	889	952
Y .4040	63	125	187	249	312	374	437	499	562	624	686	749	811	874	936
Z .4130	61	122	183	244	305	366	427	488	549	611	671	733	793	855	915

Wire Gauge Sizes

Drill Size Wire / Dec	Feet per Minute														
	10'	20'	30'	40'	50'	60'	70'	80'	90'	100'	110'	120'	130'	140'	150'
	Revolutions Per Minute														
1 .2280	111	221	332	442	553	663	774	884	995	1106	1216	1327	1438	1548	1659
2 .2210	114	228	342	456	570	684	799	912	1026	1140	1255	1369	1483	1597	1711
3 .2130	118	237	355	473	592	710	828	946	1065	1183	1303	1420	1538	1657	1775
4 .2090	121	241	362	482	603	724	845	965	1086	1206	1327	1447	1568	1690	1809
5 .2055	123	246	368	491	614	736	859	981	1104	1227	1350	1472	1595	1717	1840
6 .2040	123	247	371	494	618	741	865	989	1112	1236	1360	1483	1606	1730	1854
7 .2010	125	251	376	502	627	752	878	1003	1129	1254	1379	1505	1630	1756	1881
8 .1990	127	253	380	507	634	760	886	1013	1140	1267	1393	1520	1647	1773	1900
9 .1960	129	257	386	515	644	772	900	1029	1158	1286	1415	1544	1672	1800	1929
10 .1935	130	261	391	521	651	781	912	1042	1173	1303	1433	1564	1694	1824	1954
11 .1910	132	264	396	528	660	792	924	1056	1188	1320	1452	1584	1716	1848	1981
12 .1890	133	267	400	533	667	801	934	1067	1201	1334	1467	1601	1734	1867	2001
13 .1850	136	273	409	545	681	818	957	1090	1227	1363	1499	1636	1771	1908	2044
14 .1820	139	277	416	554	693	831	970	1108	1247	1385	1524	1662	1800	1939	2078
15 .1800	141	281	421	562	702	842	983	1123	1263	1404	1540	1680	1821	1961	2101
16 .1770	143	285	427	570	712	855	997	1139	1282	1424	1567	1709	1852	1994	2136
17 .1730	146	292	437	583	729	875	1020	1166	1311	1457	1603	1749	1894	2040	2187
18 .1695	149	298	447	597	746	895	1044	1193	1342	1492	1636	1785	1934	2082	2231
19 .1660	152	304	455	607	760	911	1063	1215	1367	1519	1670	1822	1974	2127	2279
20 .1610	156	314	470	626	783	939	1096	1253	1409	1566	1723	1879	2035	2193	2349
21 .1590	158	317	476	634	793	951	1109	1269	1427	1585	1745	1903	2061	2220	2379
22 .1570	160	321	482	642	803	964	1124	1284	1445	1606	1766	1927	2088	2248	2408
23 .1540	164	327	491	655	818	982	1146	1309	1473	1637	1800	1964	2128	2292	2455
24 .1520	166	332	498	663	830	995	1161	1327	1493	1659	1824	1991	2156	2322	2488
25 .1495	169	337	506	675	842	1012	1181	1349	1518	1686	1855	2024	2193	2361	2529
26 .1470	172	343	514	686	857	1029	1201	1371	1543	1715	1886	2058	2229	2401	2573
27 .1440	175	350	525	700	876	1051	1226	1401	1576	1751	1927	2101	2276	2451	2626
28 .1405	180	359	539	718	898	1076	1256	1436	1615	1795	1973	2153	2332	2512	2691
29 .1360	185	371	556	742	927	1112	1298	1483	1668	1854	2039	22243	2410	2595	2781
30 .1285	196	393	589	785	981	1177	1373	1569	1766	1962	2158	2354	2550	2747	2943
31 .1200	210	420	630	840	1051	1261	1470	1680	1891	2101	2311	2522	2731	2941	3152
32 .1160	217	435	652	869	1087	1304	1521	1738	1956	2173	2391	2608	2825	3043	3260
33 .1130	223	446	669	892	1115	1338	1562	1785	2008	2231	2454	2677	2900	3123	3346
34 .1110	227	454	681	908	1136	1363	1590	1817	2044	2272	2498	2725	2953	3180	3407
35 .1100	229	458	688	917	1146	1375	1604	1833	2063	2292	2522	2750	2979	3208	3438
36 .1065	237	473	710	947	1184	1420	1657	1894	2130	2367	2604	2841	3078	3314	3551
37 .1040	242	485	727	970	1212	1455	1697	1939	2182	2424	2666	2909	3152	3394	3636
38 .1015	248	497	745	993	1242	1490	1738	1987	2235	2484	2732	2981	3229	3478	3726
39 .0995	253	507	760	1014	1267	1520	1773	2027	2280	2534	2787	3041	3294	3547	3800
40 .0980	257	515	772	1029	1286	1544	1801	2058	2315	2573	2829	3087	3344	3602	3858
41 .0960	263	525	788	1051	1313	1575	1838	2101	2363	2626	2889	3152	3414	3676	3939
42 .0935	269	539	809	1078	1348	1618	1888	2157	2427	2696	2966	3235	3505	3775	4044
43 .0890	283	566	850	1133	1416	1700	1983	2266	2550	2833	3116	3399	3682	3965	4249
44 .0860	293	586	880	1173	1466	1759	2052	2346	2639	2932	3225	3518	3811	4104	4397
45 .0820	308	615	922	1230	1537	1845	2152	2459	2767	3074	3382	3689	3997	4305	4611
46 .0810	312	622	934	1245	1556	1868	2179	2490	2801	3113	3423	3735	4046	4357	4669
47 .0785	321	642	964	1284	1606	1927	2248	2569	2890	3212	3532	3854	4175	4496	4817
48 .0760	332	663	995	1327	1659	1991	2322	2654	2985	3317	3648	3980	4312	4644	4976
49 .0730	345	691	1036	1381	1727	2072	2418	2763	3109	3454	3799	4144	4493	4835	5180
50 .0700	360	720	1080	1441	1801	2161	2521	2882	3241	3602	3961	4322	4682	5042	5402
51 .0670	376	752	1129	1505	1882	2258	2634	3010	3386	3763	4139	4515	4893	527	5644
52 .0635	397	794	1191	1588	1985	2382	2779	3176	3573	3970	4369	4764	5161	5558	5955
53 .0595	423	847	1270	1694	2117	2540	2963	3386	3810	4233	4661	5085	5508	5932	6356
54 .0550	458	917	1375	1833	2292	2750	3209	3667	4126	4584	5042	5500	5958	6417	6875
55 .0520	485	970	1455	1939	2424	2909	3394	3879	4363	4848	5333	5818	6302	6787	7278
56 .0465	542	1084	1627	2169	2711	3253	3796	4338	4880	5422	5964	6506	7047	7590	8133
57 .0430	586	1173	1763	2350	2938	3526	4113	4701	5289	5876	6449	7036	7622	8208	8795
58 .0420	601	1201	1801	2400	3001	3601	4202	4802	5403	6003	6603	7203	7803	8403	9004
59 .0410	615	1230	1845	2459	3074	3689	4304	4919	5536	6149	6764	7379	7993	8608	9224
60 .0400	630	1261	1891	2521	3152	3781	4411	5042	5672	6302	6933	7563	8193	8824	9454

Cleveland offers an extensive array of threading tools. The Cleveland brand is known for performance tools that run faster, longer, and with more precision than competitive tools. This Threading section includes: high performance taps, various hand, flute, spiral, forming, and pipe taps as well as dies and assemblies. Also included are our carbide mini, and carbide helical thread mills. We have a large selection of surface treatments, and industry specific application products.



FAST TAP

Common Special Taps and Special Taps from Blanks



Delivery Matrix

Quantities listed are *maximum* pieces for working days listed. Common special taps and special taps from blanks.

Surface Treatments

(added days to lead times below)

Steam Oxide	2 days
Steam Oxide over Nitride	2 days
TiN	5 days
TiCN	7 days

	24 Hrs	2 Days	3 Days	4 Days	5 Days	6 Days
60 Degree Thread Forms						
Smaller Than #4	12	24	48			
#4 thru 1/4"	24	48				
5/16" thru 1/2"	24	48				
9/16" thru 1"	12	24	48			
** 1-1/16 thru 1-1/2"	6	12	24			
1-9/16 thru 3"	3	6				
Over 3"	1	3				
Pipe Taps						
1/16" thru 3/8"	6	24	48			
1/2" thru 1"	3	12	24			
1-1/4" thru 2"	2	6	12			
Over 2"	Delivery is 12 to 15 Working Days					
Form Taps						
0 thru 3/8"	12	24	48			
7/16" thru 3/4"	12	24		48		
13/16" thru 1"		12	24			
ACME/Buttress						
1/4" thru 1-1/2"					12	24
Tandem ACMEs						
3/8" thru 2"					12	

** Spiral Point add 1 day.

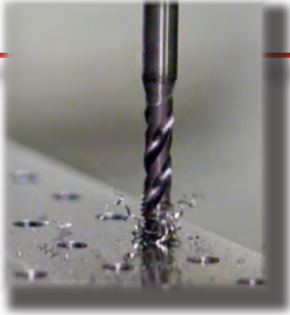

Threading Product Index156-223

- | | |
|---------------------|--------------|
| Hand Taps | Pipe Taps |
| Straight Flute Taps | Dies |
| Spiral Point Taps | Wrenches |
| Spiral Flute Taps | Thread Mills |
| Form Taps | |

Cost Saving Sets



Complete list of Threading Sets 202

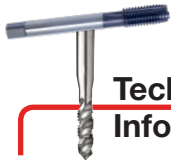

Technical Information

Tap Nomenclature / Chamfers	204
Tap and Drill Recommendations	206
Hardness Conversion Table	207
Standard Tap Marking Systems	208
Application Data	
Progress / Performance Taps	209
Tapping Speed	210
USCTI Table 302	212
USCTI Table 302A	213
USCTI Table 311	214
USCTI Table 327	215
USCTI Table 329	216
USCTI Table 331	217
USCTI Table 341	218
USCTI Table 352	219
Thread Mill Operating Parameters	222
Made to Order, Special Taps, FastTap	223



TECH TIPS

Gauging Threaded Holes	203
NPT vs. NPTF Taper Pipe Threads	203
How to request Made-to-Order taps	222
Ground Thread Tap Limits	223
Proper Use of Lubricants	223







Table of Contents









Surface Treatment











Additional treatments available upon request.





Straight Flute					Tool Material	Blank		Chamfer			Application				Hole		Surface Treatment												
Type	Style	Page	Set		HSS	HSS-E	302A	311	DIN / ANSI	Taper	Plug	Bottoming	Mod Bottoming	Steel	Stainless	Cast Iron	Non-Ferrous	High-Temp Alloy	Hardened Steel	Blind	Thru	Bright	Black Oxide	TiN	TiCN	TiAlN	AlCrN	Oxide over Nitride	Hardlube
	General Purpose	1001	162	yes	•	•				•				•	•	•	•				•	•	•						
	General Purpose	1002	165	yes	•	•					•			•	•	•	•				•	•	•						
	General Purpose	1003	165	yes	•	•						•		•	•	•	•			•	•	•							
	Set (Styles: 1001, 1002, 1003)	1004	165	yes	•	•				•	•	•		•	•	•	•				•	•							
	General Purpose - Left Hand	1002L	166		•	•					•			•	•	•	•				•	•							
	Cast Iron	CI-1000	167		•	•							•	•	•	•	•										•		







Spiral Point					Tool Material	Blank		Chamfer			Application				Hole		Surface Treatment												
Type	Style	Page	Set		HSS	HSS-E	302A	311	DIN / ANSI	Taper	Plug	Bottoming	Mod Bottoming	Steel	Stainless	Cast Iron	Non-Ferrous	High-Temp Alloy	Hardened Steel	Blind	Thru	Bright	Black Oxide	TiN	TiCN	TiAlN	AlCrN	Oxide over Nitride	Hardlube
	General Purpose	1011	168		•	•					•			•	•	•	•				•	•	•						
	Low Shear	1053	171		•	•					•			•	•	•	•				•	•	•						
	Bottoming	1012	172		•	•						•		•	•	•	•			•	•	•							
	6" Extended Length	1011E	172		•	•	303-A				•			•	•	•	•				•	•							
	Stainless Steel & Steel	T-101	173		•	•					•			•	•	•	•				•	•	•						
	Universal	PRO-961SP	174		•	•					•			•	•	•	•				•	•							
	Universal	PRO-861SP			•	•						•			•	•	•	•				•	•				•		
	Stainless Steel	PER-862SP	176		•	•					•			•	•	•	•				•	•							
	Stainless Steel	PER-960SP			•	•						•			•	•	•	•				•	•						•













Spiral Flute					Tool Material	Blank	Chamfer	Application	Hole	Surface Treatment																			
	Type	Style	Page	Set	HSS	HSS-E	302A	311	DIN / ANSI	Taper	Plug	Bottoming	Mod Bottoming	Steel	Stainless	Cast Iron	Non-Ferrous	High-Temp Alloy	Hardened Steel	Blind	Thru	Bright	Black Oxide	TiN	TiCN	TiAlN	AlCrN	Oxide over Nitride	Hardlube
	General Purpose	1093	178		•		•				•			•	•	•	•			•		•	•						
	General Purpose	1094	178		•		•					•		•	•	•	•			•		•	•						
	Heavy Duty	1095	179		•		•				•			•	•	•	•			•		•	•						
	Heavy Duty	1096	179		•		•					•		•	•	•	•			•		•	•						
	Stainless Steel & Steel	B-101	180			•						•		•	•	•	•			•		•	•						
	Universal	PRO-981SF	181			•			•				•	•	•	•	•			•		•	•						
	Universal	PRO-892SF					•			•				•	•	•	•	•			•		•	•					
	Stainless Steel	PER-893SF	183			•			•				•	•	•	•	•			•		•	•						
	Stainless Steel	PER-980SF					•			•				•	•	•	•	•			•		•	•					•

Form					Tool Material	Blank	Chamfer	Application	Hole	Surface Treatment																			
	Type	Style	Page	Set	HSS	HSS-E	302A	311	DIN / ANSI	Taper	Plug	Bottoming	Mod Bottoming	Steel	Stainless	Cast Iron	Non-Ferrous	High-Temp Alloy	Hardened Steel	Blind	Thru	Bright	Black Oxide	TiN	TiCN	TiAlN	AlCrN	Oxide over Nitride	Hardlube
	General Purpose	1091	185		•		•				•			•	•	•	•			•		•	•						
	General Purpose	1092	185		•		•					•		•	•	•	•			•		•	•						

Pipe					Tool Material	Blank	Chamfer	Application	Hole	Surface Treatment																			
	Type	Style	Page	Set	HSS	HSS-E	302A	311	DIN / ANSI	Taper	Plug	Bottoming	Mod Bottoming	Steel	Stainless	Cast Iron	Non-Ferrous	High-Temp Alloy	Hardened Steel	Blind	Thru	Bright	Black Oxide	TiN	TiCN	TiAlN	AlCrN	Oxide over Nitride	Hardlube
	NPT Medium Hook	965	186		•		•			•				•	•	•	•					•	•						
	NPTF Medium Hook	975	186		•		•			•				•	•	•	•					•	•						
	NPT Interrupted Thread	964B	187		•		•			•				•	•	•	•					•	•						
	NPTF Interrupted Thread	966B	187		•		•			•				•	•	•	•					•	•						
	NPS	963B	188		•		•					•		•	•	•	•					•	•						
	NPSF	967B	188		•		•					•		•	•	•	•					•	•						





Index

Thread Mills					Tool Material		Thread							Application					Coolant		Surface Treatment							
	Type	Style	Page	Set	HSS	Cobalt	Carbide	UNC	UNF	NPT	NPTF	Metric Coarse	Metric Fine	BSPP	BSPT	DIN	Steel	Stainless	Cast Iron	Non-Ferrous	Special Alloy	Hardened Steel	Non	Thru	TAIN	AlCrN	Hardlube	
	Mini	CMTM2, CMTMM2	189			•	•	•				•	•				•	•	•	•	•	•	•			•		
	Mini	CMTM3, CMTMM3	190			•	•	•				•	•				•	•	•	•	•	•	•			•		
	General Purpose - Inch	CTM, CTMC	191			•	•	•									•	•	•	•	•	•	•	•	•			
	General Purpose - Metric	CTMM, CTMMC	192			•									•		•	•	•	•	•	•	•	•	•			
	National Pipe Tapered	CTMNP, CTMNPC	192			•			•	•							•	•	•	•	•	•	•	•	•			
	British Pipe Tapered	CTMBPP, CTMBPPC	193			•								•			•	•	•	•	•	•	•	•	•			
	British Pipe Parallel	CTMBPT, CTMBPTC	193			•								•			•	•	•	•	•	•	•	•	•			

Dies					Tool Material			Surface Treatment							
					HSS	Carbon Steel	Steel	Bright	Black Oxide	TiN	TiCN	TiAlN	AlCrN	Oxide over Nitride	Hardlube
	Type	Style	Page	Set											
	Hexagon Rethreading	0650, 0650M, 492	194-195	yes	•	•		•							
	Taper Pipe	0660			•	•		•							
	Round Adjustable	0610, 0710	196-198		•	•		•							
	Round Adjustable	0710M			•			•							
	Round Adjustable - Pipe	0620				•		•							
	Die Stock, Adjustable	222	198												
	Die Stock, Built-in Workpiece Guide	224	198												
	Die Set: Die Halves	0550	199-200				•	•							
	Die Set: Cap	0551							•	•					
	Die Set: Guide	0552							•	•					
	Die Set: Collet (cap and guide)	0553							•	•					
	Die Set Assembly (0550,0553,0551,0552)	0554							•	•					
	Quick Set Die Stock	223	200			•			•						
	Quick Set Jr. Die Stock	225	200			•			•						
	Quick Set Spanner Wrench	226	200												

Index

Wrenches

	Type	Style	Page		Type	Style	Page
	Straight Wrench	240	201		Combo Ratchet & Slip Handle Wrench	244	201
	Plain T-Handle Wrench	242	201		Long Shank T-Handle Wrench	245	201
	Slip T-Handle Wrench	243	201				

Threading

General Purpose
Inch

Styles: **1001, 1001TN, 1002, 1002SO, 1002TN, 1002TC, 1003, 1003TN, 1004**



Note
Tapping Speeds and Feeds see Technical section.

Set # 1004 consists of one each taper, plug, and bottoming chamfers - Bright.



Surface Treatment

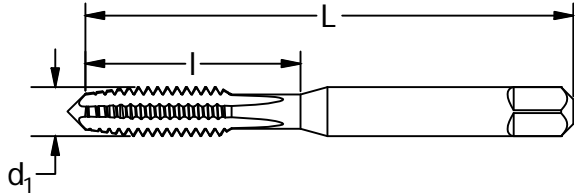

Feature:

New neck down style. Three different chamfers for maintenance and repair versatility.

Hand Tap

High Speed Steel

tap size pitch	thrd form	dec. equiv.	# of flutes	H- limit	overall length L (in)	thread length I (in)	order number									
							Taper		Plug			Bottoming		Set		
d1							1001 Bright	1001TN TiN	1002 Bright	1002SO Bl. oxide	1002TN TiN	1002TC TiCN	1003 Bright	1003TN TiN	1004 Bright	
*0-80	UNF	.0600	2	H1	1.625	.313	C54025	—	C54026	—	—	—	C54027	—	—	
*0-80	UNF	.0600	2	H2	1.625	.313	—	—	C54029	—	C55156	—	C54030	—	—	
*1-64	UNC	.0730	2	H1	1.688	.375	C54055	—	C54056	—	—	—	C54057	—	—	
*1-72	UNF	.0730	2	H1	1.688	.375	C54060	—	C54061	—	—	—	C54062	—	—	
*2-56	UNC	.0860	3	H1	1.750	.375	C54083	—	C54084	—	—	—	C54085	—	—	
*2-56	UNC	.0860	2	H2	1.750	.375	—	—	C54087	—	—	—	C54088	—	—	
*2-56	UNC	.0860	3	H2	1.750	.375	C54089	—	C54090	—	C55158	C56050	C54091	—	C54092	
*2-64	UNF	.0860	3	H2	1.750	.438	C54093	—	C54094	—	—	—	C54095	—	—	
*3-48	UNC	.0990	3	H2	1.813	.500	C54115	—	C54116	—	—	—	C54117	—	C54118	
*3-56	UNF	.0990	3	H2	1.813	.500	C54120	—	C54121	—	—	—	C54122	—	C54123	
4-40	UNC	.1120	2	H1	1.875	.563	—	—	C54142	—	—	—	—	—	—	
4-40	UNC	.1120	2	H2	1.875	.563	—	—	C54147	—	—	—	C54148	—	—	
4-40	UNC	.1120	3	H2	1.875	.563	C54149	—	C54150	—	C55160	C56052	C54151	—	C54152	
4-48	UNF	.1120	3	H2	1.875	.563	C54153	—	C54154	—	—	—	C54155	—	C54156	
5-40	UNC	.1250	2	H2	1.938	.625	—	—	C54186	—	—	—	C54187	—	—	
5-40	UNC	.1250	3	H2	1.938	.625	C54188	—	C54189	—	C55162	—	C54190	—	C54191	
5-44	UNF	.1250	3	H2	1.938	.625	C54192	—	C54193	—	—	—	C54194	—	C54195	
6-32	UNC	.1380	2	H2	2.000	.688	—	—	C54215	—	—	—	C54216	—	—	
6-32	UNC	.1380	3	H2	2.000	.688	C54217	—	C54218	—	C55164	—	C54219	—	C54220	
6-32	UNC	.1380	2	H3	2.000	.688	—	—	C54221	—	—	—	C54222	—	—	
6-32	UNC	.1380	3	H3	2.000	.688	C54223	—	C54224	C56000	C55100	C56054	C54225	C55200	C54226	
6-40	UNF	.1380	3	H2	2.000	.688	C54232	—	C54233	—	C55102	—	C54234	C55202	C54235	
8-32	UNC	.1640	2	H1	2.125	.750	—	—	C54256	—	—	—	—	—	—	
8-32	UNC	.1640	2	H2	2.125	.750	—	—	C54264	—	—	—	C54265	—	—	
8-32	UNC	.1640	3	H2	2.125	.750	—	—	C54267	—	—	—	C54268	—	—	
8-32	UNC	.1640	4	H2	2.125	.750	C54269	—	C54270	—	C55166	—	C54271	—	C54272	
8-32	UNC	.1640	2	H3	2.125	.750	—	—	C54273	—	—	—	C54274	—	—	
8-32	UNC	.1640	3	H3	2.125	.750	—	—	C54275	—	—	—	C54276	—	—	
8-32	UNC	.1640	4	H3	2.125	.750	C54277	C54307	C54278	C56002	C55104	C56056	C54279	C55204	C54280	
8-36	UNF	.1640	4	H2	2.125	.750	C54289	—	C54290	—	C55106	—	C54291	—	C54292	
10-24	UNC	.1900	2	H2	2.375	.875	—	—	C54318	—	—	—	—	—	—	
10-24	UNC	.1900	4	H2	2.375	.875	C54321	—	C54322	—	—	—	C54323	—	C54324	
10-24	UNC	.1900	2	H3	2.375	.875	—	—	C54325	—	—	—	C54326	—	—	
10-24	UNC	.1900	3	H3	2.375	.875	—	—	C54327	—	—	—	C54328	—	—	
10-24	UNC	.1900	4	H3	2.375	.875	C54329	—	C54330	C56004	C55108	C56058	C54331	C55208	C54332	
10-32	UNF	.1900	2	H2	2.375	.875	—	—	C54343	—	—	—	—	—	—	
10-32	UNF	.1900	4	H2	2.375	.875	C54348	—	C54349	—	—	—	C54350	—	C54351	
10-32	UNF	.1900	2	H3	2.375	.875	—	—	C54352	—	—	—	C54353	—	—	

* #0 - #3 and larger than 1": 302 blank style.

continued on next page



tap size pitch d1	thrd form	dec. equiv.	# of flutes	H- limit	overall length L (in)	thread length I (in)	order number									
							Taper		Plug				Bottoming		Set	
							1001 Bright	1001TN TiN	1002 Bright	1002SO Bl. oxide	1002TN TiN	1002TC TiCN	1003 Bright	1003TN TiN	1004 Bright	
10-32	UNF	.1900	3	H3	2.375	.875	—	—	C54354	—	C55170	—	C54355	—	—	
10-32	UNF	.1900	4	H3	2.375	.875	C54356	C54309	C54357	C56006	C55110	C56060	C54358	C55210	C54359	
12-24	UNC	.2160	4	H3	2.375	.938	C54385	—	C54386	—	C55112	—	C54387	C55212	C54388	
12-28	UNF	.2160	4	H3	2.375	.938	C54389	—	C54390	—	C55114	—	C54391	C55214	C54392	
1/4-20	UNC	.2500	4	H1	2.500	1.000	C54443	—	C54444	—	—	—	C54445	—	C54447	
1/4-20	UNC	.2500	3	H2	2.500	1.000	—	—	C54451	—	—	—	—	—	—	
1/4-20	UNC	.2500	4	H2	2.500	1.000	C54448	—	C54449	—	—	—	C54450	—	C54452	
1/4-20	UNC	.2500	2	H3	2.500	1.000	—	—	C54456	—	—	—	C54457	—	—	
1/4-20	UNC	.2500	3	H3	2.500	1.000	—	—	C54458	—	—	—	C54459	—	—	
1/4-20	UNC	.2500	4	H3	2.500	1.000	C54453	—	C54454	C56008	C55116	C56062	C54455	C55216	C54460	
1/4-20	UNC	.2500	3	H5	2.500	1.000	—	—	C54463	—	—	—	—	—	—	
1/4-20	UNC	.2500	4	H5	2.500	1.000	—	—	C54461	—	—	—	C54462	—	—	
1/4-20	UNC	.2500	4	H11	2.500	1.000	—	—	C54464	—	—	—	—	—	—	
1/4-28	UNF	.2500	4	H2	2.500	1.000	—	—	C54467	—	—	—	C54468	—	—	
1/4-28	UNF	.2500	2	H3	2.500	1.000	—	—	C54472	—	—	—	C54473	—	—	
1/4-28	UNF	.2500	3	H3	2.500	1.000	—	—	C54474	—	—	—	C54475	—	—	
1/4-28	UNF	.2500	4	H3	2.500	1.000	C54469	—	C54470	C56010	C55118	C56064	C54471	C55218	C54476	
5/16-18	UNC	.3125	4	H2	2.719	1.125	—	—	C54502	—	—	—	C54503	—	—	
5/16-18	UNC	.3125	2	H3	2.719	1.125	—	—	C54507	—	—	—	C54508	—	—	
5/16-18	UNC	.3125	3	H3	2.719	1.125	—	—	C54509	—	—	—	C54510	—	—	
5/16-18	UNC	.3125	4	H3	2.719	1.125	C54504	—	C54505	C56012	C55120	C56066	C54506	C55220	C54511	
5/16-18	UNC	.3125	4	H5	2.719	1.125	—	—	C54512	—	—	—	C54513	—	—	
5/16-18	UNC	.3125	4	H11	2.719	1.125	—	—	C54514	—	—	—	—	—	—	
5/16-24	UNF	.3125	3	H3	2.719	1.125	—	—	C54521	—	—	—	C54522	—	—	
5/16-24	UNF	.3125	4	H3	2.719	1.125	C54518	—	C54519	—	C55122	—	C54520	C55222	C54523	
5/16-24	UNF	.3125	4	H4	2.719	1.125	—	—	C54524	—	—	—	C54525	—	—	
3/8-16	UNC	.3750	4	H2	2.938	1.250	—	—	C54580	—	C55124	—	C54581	—	—	
3/8-16	UNC	.3750	3	H3	2.938	1.250	—	—	C54585	—	C55180	—	C54586	—	—	
3/8-16	UNC	.3750	4	H3	2.938	1.250	C54582	—	C54583	C56014	—	C56070	C54584	C55224	C54587	
3/8-16	UNC	.3750	4	H5	2.938	1.250	—	—	C54588	—	—	—	C54589	—	—	
3/8-24	UNF	.3750	3	H3	2.938	1.250	—	—	C54598	—	—	—	C54599	—	—	
3/8-24	UNF	.3750	4	H3	2.938	1.250	C54595	—	C54596	C56016	C55126	—	C54597	C55226	C54600	
7/16-14	UNC	.4375	4	H3	3.156	1.438	C54652	—	C54653	—	C55128	—	C54654	C55228	C54656	
7/16-14	UNC	.4375	4	H5	3.156	1.438	—	—	C54658	—	—	—	C54659	—	—	
7/16-20	UNF	.4375	4	H3	3.156	1.438	C54661	—	C54662	—	C55130	—	C54663	C55230	C54665	
7/16-20	UNF	.4375	4	H5	3.156	1.438	—	—	C54666	—	—	—	C54667	—	—	
1/2-13	UNC	.5000	4	H1	3.375	1.656	—	—	C54724	—	—	—	—	—	—	
1/2-13	UNC	.5000	3	H3	3.375	1.656	—	—	C54729	—	—	—	C54730	—	—	
1/2-13	UNC	.5000	4	H3	3.375	1.656	C54726	—	C54727	C56020	C55132	C56076	C54728	C55232	C54731	
1/2-13	UNC	.5000	4	H5	3.375	1.656	—	—	C54732	—	—	—	C54733	—	—	
1/2-20	UNF	.5000	3	H3	3.375	1.656	—	—	C54740	—	—	—	—	—	—	
1/2-20	UNF	.5000	4	H3	3.375	1.656	C54737	—	C54738	—	C55134	—	C54739	C55234	C54741	
1/2-20	UNF	.5000	4	H5	3.375	1.656	—	—	C54742	—	—	—	—	—	—	

Hand Tap
High Speed Steel
continued on next page

Material Reference	Steel (HRC)				Stainless Steel			Cast Iron (HRC)		Aluminum and Non-Ferrous	Hi-Temp Alloy		Hardened Steel (HRC)
	Low Carbon		Alloy		Austenitic	Martensitic	PH	Gray	Nodular		Ni, Co, Fe Based Super Alloy	Titanium	
	Hardness	13-38	>38	16-38	> 38	300 Series	400 series		18-22	22-32			>45
Bright	◆		◆		◆			◆	◆	◆			
TiN	◆		◆		◆			◆	◆				
TiCN	☆		☆		☆	◆		☆	☆	☆			

☆ = Best Performance ◆ = Acceptable

Threading

General Purpose
Inch

Styles: **1001, 1001TN, 1002, 1002SO, 1002TN, 1002TC, 1003, 1003TN, 1004** (continued)



Hand Tap

High Speed Steel

tap size pitch d1	thrd form	dec. equiv.	# of flutes	H- limit	overall length L (in)	thread length l (in)	order number								
							Taper		Plug			Bottoming		Set	
							1001 Bright	1001TN TiN	1002 Bright	1002SO Bl. oxide	1002TN TiN	1002TC TiCN	1003 Bright	1003TN TiN	1004 Bright
9/16-12	UNC	.5625	4	H3	3.594	1.656	C54759	—	C54760	—	C55136	—	C54761	C55236	C54762
9/16-18	UNF	.5625	4	H3	3.594	1.656	C54765	—	C54766	—	C55138	—	C54767	C55238	C54768
5/8-11	UNC	.6250	4	H3	3.813	1.813	C54779	—	C54780	C56028	C55140	—	C54781	C55240	C54782
5/8-11	UNC	.6250	4	H5	3.813	1.813	—	—	C54783	—	—	—	C54784	—	—
5/8-18	UNF	.6250	4	H3	3.813	1.813	C54787	—	C54788	—	C55142	—	C54789	C55242	C54790
11/16-11	UNS	.6875	4	H3	4.031	1.813	C54813	—	C54814	—	—	—	C54815	—	C54816
11/16-16	UNS	.6875	4	H3	4.031	1.813	C54817	—	C54818	—	—	—	C54819	—	C54820
3/4-10	UNC	.7500	4	H3	4.250	2.000	C54838	—	C54839	—	C55144	—	C54840	C55244	C54841
3/4-16	UNF	.7500	4	H3	4.250	2.000	C54846	—	C54847	—	C55146	—	C54848	C55246	C54849
7/8-9	UNC	.8750	4	H4	4.688	2.219	C54884	—	C54885	—	C55148	—	C54886	C55248	C54887
7/8-14	UNF	.8750	4	H4	4.688	2.219	C54890	—	C54891	—	C55150	—	C54892	C55250	C54893
1-8	UNC	1.0000	4	H4	5.125	2.500	C54923	—	C54924	—	C55152	—	C54925	C55252	C54926
1-12	UNF	1.0000	4	H4	5.125	2.500	C54928	—	C54929	—	C55154	—	C54930	—	—
1-14	UNS	1.0000	4	H4	5.125	2.500	C54933	—	C54934	—	—	—	C54935	—	C54936
*1-1/8-7	UNC	1.1250	4	H4	5.438	2.563	C54965	—	C54966	—	—	—	C54967	—	—
*1-1/8-12	UNF	1.1250	4	H4	5.438	2.563	C54971	—	C54972	—	—	—	C54973	—	—
*1-1/4-7	UNC	1.2500	4	H4	5.750	2.563	C54994	—	C54995	—	—	—	C54996	—	—
*1-1/4-12	UNF	1.2500	6	H4	5.750	2.563	C55000	—	C55001	—	—	—	C55002	—	—
*1-3/8-6	UNC	1.3750	4	H4	6.0625	3.000	—	—	C55028	—	—	—	—	—	—
*1-3/8-12	UNF	1.3750	6	H4	6.0625	3.000	—	—	C55031	—	—	—	C55032	—	—
*1-1/2-6	UNC	1.5000	4	H4	6.375	3.000	C55057	—	C55058	—	—	—	C55059	—	—
*1-1/2-12	UNF	1.5000	6	H4	6.375	3.000	C55063	—	C55064	—	—	—	C55065	—	—

* #0 - #3 and larger than 1": 302 blank style.

Hand Taps

SET

Style: **1002**



plug chamfer

bright finish

order number

Tap Sizes:	UNC	1/4-20, 5/16-18, 3/8-16, 7/16-14, 1/2-13
	UNF	1/4-28, 5/16-24, 3/8-24, 7/16-20, 1/2-20

1002

C55090

Material Reference	Steel (HRC)				Stainless Steel			Cast Iron (HRC)		Aluminum and Non-Ferrous	Hi-Temp Alloy		Hardened Steel (HRC)
	Low Carbon		Alloy		Austenitic	Martensitic	PH	Gray	Nodular		Ni, Co, Fe Based Super Alloy	Titanium	
	Hardness	13-38	>38	16-38	> 38	300 Series	400 series		18-22	22-32			>45
Bright	◆		◆		◆			◆	◆	◆			
TiN	◆		◆		◆			◆	◆				
TiCN	☆		☆		☆	◆		☆	☆	☆			

☆ = Best Performance ◆ = Acceptable

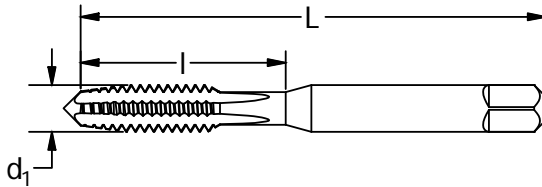

Styles: 1001, 1002, 1003, 1004
Note
Tapping Speeds and Feeds see Technical section.
Set #1004 consists of one each taper, plug, and bottoming chamfers - Bright.

Surface Treatment

Feature:

New neck down style.

tap size	thrd pitch	form	dec. equiv.	metric equiv.	# of flutes	D-limit	overall length		thread length		order number			
							L	mm	I	mm	Taper 1001 Bright	Plug 1002 Bright	Bottoming 1003 Bright	Set 1004 Bright
*M1.6 x 0.35	.0630	1.60	2	D3	1.625	41.28	.313	7.94	—	C54044	C54045	—		
*M2 x 0.4	.0787	2.00	3	D3	1.750	44.45	.438	11.11	C54073	C54074	C54075	—		
*M2.5 x 0.45	.0984	2.50	3	D3	1.813	46.04	.500	12.70	C54131	C54132	C54133	—		
M3 x 0.5	.1181	3.00	3	D3	1.938	49.21	.625	15.88	C54164	C54165	C54166	C54167		
M3.5 x 0.6	.1378	3.50	3	D4	2.000	50.80	.688	17.46	C54203	C54204	C54205	—		
M4 x 0.7	.1575	4.00	4	D4	2.125	53.98	.750	19.05	C54246	C54247	C54248	C54249		
M4.5 x 0.75	.1771	4.50	4	D4	2.375	60.33	.875	22.23	C54303	C54304	C54305	—		
M5 x 0.8	.1968	5.00	4	D4	2.375	60.33	.875	22.23	C54374	C54375	C54376	C54377		
M6 x 1	.2362	6.00	4	D5	2.500	63.50	1.000	25.40	C54413	C54414	C54415	C54416		
M7 x 1	.2756	7.00	4	D5	2.719	69.06	1.125	28.58	C54489	C54490	C54491	—		
M8 x 1	.3150	8.00	4	D5	2.719	69.06	1.125	28.58	C54536	C54537	C54538	—		
M8 x 1.25	.3150	8.00	4	D5	2.719	69.06	1.125	28.58	C54546	C54547	C54548	C54539		
M10 x 1.25	.3937	10.00	4	D5	2.938	74.61	1.250	31.75	C54617	C54618	C54619	—		
M10 x 1.5	.3937	10.00	4	D6	2.938	74.61	1.250	31.75	C54624	C54625	C54626	C54627		
M12 x 1.25	.4724	12.00	4	D5	3.375	85.73	1.656	42.07	C54675	C54676	C54677	—		
M12 x 1.75	.4724	12.00	4	D6	3.375	85.73	1.656	42.07	C54689	C54690	C54691	C54692		
M14 x 1.5	.5512	14.00	4	D6	3.594	91.28	1.656	42.07	C54751	C54752	C54753	—		
M14 x 2	.5512	14.00	4	D7	3.594	91.28	1.656	42.07	C54755	C54756	C54757	C54758		
M16 x 1.5	.6299	16.00	4	D6	3.813	96.84	1.813	46.04	C54797	C54798	C54799	—		
M16 x 2	.6299	16.00	4	D7	3.813	96.84	1.813	46.04	C54801	C54802	C54803	C54804		
M18 x 1.5	.7087	18.00	4	D6	4.031	102.39	1.813	46.04	C54825	C54826	—	—		
M18 x 2.5	.7087	18.00	4	D7	4.031	102.39	1.813	46.04	C54833	C54834	C54835	—		
M20 x 1.5	.7874	20.00	4	D6	4.469	113.51	2.000	50.80	—	C54857	C54858	—		
M20 x 2.5	.7874	20.00	4	D7	4.469	113.51	2.000	50.80	C54864	C54865	C54866	C54867		
M24 x 3	.9449	24.00	4	D8	4.906	124.62	2.219	56.36	C54907	C54908	C54909	—		
M30 x 3.5	1.1811	30.00	4	D9	5.438	138.11	2.563	65.09	—	C54991	—	—		

*M1.6-M2.5 and larger than M25: 302 blank style

 Hand Tap
High Speed Steel

Material Reference	Steel (HRC)				Stainless Steel			Cast Iron (HRC)		Aluminum and Non-Ferrous	Hi-Temp Alloy		Hardened Steel (HRC)
	Low Carbon		Alloy		Austenitic	Martensitic	PH	Gray	Nodular		Ni, Co, Fe Based Super Alloy	Titanium	
	Hardness	13-38	>38	16-38	> 38	300 Series	400 series		18-22	22-32			>45
Bright	◆		◆		◆			◆	◆	◆			

☆ = Best Performance ◆ = Acceptable

Threading

General Purpose
Left



Styles: **1002L**

Note
Tapping Speeds and Feeds see
Technical section.

HSS
302A
Straight Flute
Thru Holes
Plug 3-5
Surface Treatment
Bright

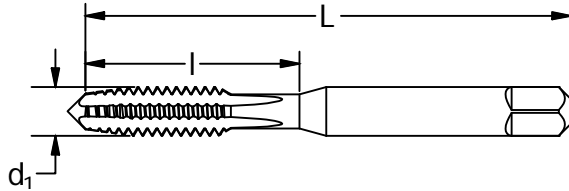

Hand Tap

High Speed Steel

tap size and pitch d_1	thread form	decimal equiv.	number of flutes	H-limit	overall length L (in)	thread length I (in)	order number 1002L Bright
#10-32	UNF	.1900	4	H3	2.3750	.8750	C60732
1/4-20	UNC	.2500	4	H3	2.5000	1.0000	C60748
1/4-28	UNF	.2500	4	H3	2.5000	1.0000	C60752
5/16-18	UNC	.3125	4	H3	2.7190	1.1250	C60760
5/16-24	UNF	.3125	4	H3	2.7190	1.1250	C60764
3/8-16	UNC	.3750	4	H3	2.9380	1.2500	C60776
3/8-24	UNF	.3750	4	H3	2.9380	1.2500	C60780
7/16-20	UNF	.4375	4	H3	3.1560	1.4380	C60796
1/2-13	UNC	.5000	4	H3	3.3750	1.6560	C60808
1/2-20	UNF	.5000	4	H3	3.3750	1.6560	C60812
5/8-18	UNF	.6250	4	H3	3.8130	1.8130	C60831
3/4-10	UNC	.7500	4	H3	4.2500	2.0000	C60835
3/4-16	UNF	.7500	4	H3	4.2500	2.0000	C60866

Material Reference	Steel (HRC)				Stainless Steel			Cast Iron (HRC)		Aluminum and Non-Ferrous	Hi-Temp Alloy		Hardened Steel (HRC)
	Low Carbon		Alloy		Austenitic	Martensitic	PH	Gray	Nodular		Ni, Co, Fe Based Super Alloy	Titanium	
Hardness	13-38	>38	16-38	> 38	300 Series	400 series		18-22	22-32				>45
Bright	☆		☆					◆		☆			

☆ = Best Performance ◆ = Acceptable



Styles: CI-1000, CI-1000-TC

Note
Tapping Speeds and Feeds see
Technical section.

Surface Treatment

Oxide over Nitride

TiCN

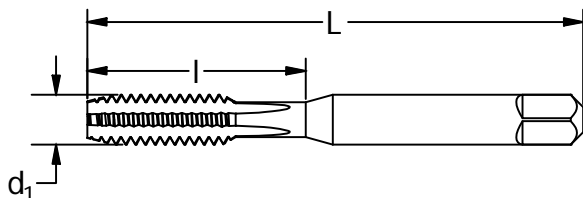
Feature:

Premium steel substrate.

tap size and pitch	thread form	decimal equiv.	number of flutes	H-limit	overall length L (in)	thread length I (in)	order number	
							CI-1000 Oxide over Nitride	CI-1000-TC TiCN
10-24	UNC	.1900	4	H3	2.375	.875	C27636	—
10-32	UNF	.1900	4	H3	2.375	.875	C27637	—
1/4-20	UNC	.2500	4	H3	2.500	1.000	C27638	C28022
1/4-20	UNC	.2500	4	H5	2.500	1.000	C27655	—
1/4-28	UNF	.2500	4	H3	2.500	1.000	C27639	—
5/16-18	UNC	.3125	4	H3	2.719	1.125	C27640	C28024
5/16-18	UNC	.3125	4	H5	2.719	1.125	C27656	—
5/16-24	UNF	.3125	4	H3	2.719	1.125	C27641	—
3/8-16	UNC	.3750	4	H3	2.938	1.250	C27642	—
3/8-16	UNC	.3750	4	H5	2.938	1.250	C27657	—
7/16-14	UNC	.4375	4	H3	3.156	1.438	C27644	—
7/16-14	UNC	.4375	4	H5	3.156	1.438	C27658	—
1/2-13	UNC	.5000	4	H3	3.375	1.656	C27646	—
1/2-13	UNC	.5000	4	H5	3.375	1.656	C27660	—
1/2-20	UNF	.5000	4	H5	3.375	1.656	C27661	—
3/4-16	UNF	.7500	6	H5	4.250	2.000	C27667	—

Straight Flute

High Speed Steel

Styles: CI-1000, CI-1000-TC
**Cast Iron - Inch
& Harder Materials**

tap size and pitch d1	decimal equiv.	number of flutes	D-limit	overall length L		thread length I		order number	
				in	mm	in	mm	CI-1000 Oxide over Nitride	CI-1000-TC TiCN
M5x0.8	0.1968	4	D4	2.375	60.33	.875	22.23	C27668	—
M6x1	0.2362	4	D5	2.500	63.50	1.000	25.4	C27669	—
M8x1.25	0.3150	4	D5	2.719	69.06	1.125	28.58	C27670	—
M10x1.5	0.3937	4	D6	2.938	74.61	1.250	31.75	C27671	C28055
M12x1.25	0.4724	4	D6	3.375	85.73	1.656	42.06	C27672	—
M12x1.75	0.4724	4	D6	3.375	85.73	1.656	42.06	C27673	C28057
M14x1.5	0.5512	4	D6	3.594	91.28	1.656	42.06	C27675	—

Material Reference	Steel (HRC)				Stainless Steel		Cast Iron (HRC)		Aluminum and Non-Ferrous	Hi-Temp Alloy		Hardened Steel (HRC)
	Low Carbon		Alloy		Austenitic	Martensitic	PH	Gray		Nodular	Ni, Co, Fe Based Super Alloy	
	Hardness	13-38	>38	16-38	> 38	300 Series	400 series		18-22	22-32		
Oxide over Nitride		☆		☆				☆				☆

☆ = Best Performance ◆ = Acceptable

Note
Tapping Speeds and Feeds see
Technical section.

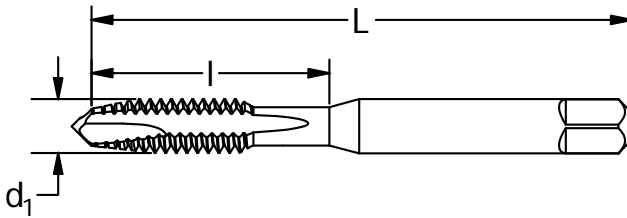

Feature:
Thru hole application in a variety of materials.

Spiral Point

High Speed Steel

tap size and pitch d_1	thread form	decimal equiv	no. of flutes	H- limit	overall length L (in)	thread length I (in)	order number			
							1011 Bright	1011SO Black Oxide	1011TN TiN	1011TC TiCN
*0-80	UNF	.0600	2	H1	1.688	.313	C57009	—	—	—
*0-80	UNF	.0600	2	H2	1.688	.313	C57011	C57600	C55290	C55370
*1-64	UNC	.0730	2	H2	1.688	.375	C57022	—	—	—
*1-72	UNF	.0730	2	H1	1.688	.375	C57023	—	—	—
*1-72	UNF	.0730	2	H2	1.688	.375	C57024	—	—	—
*2-56	UNC	.0860	2	H2	1.750	.438	C57031	C57602	C55292	C55372
*2-64	UNF	.0860	2	H2	1.750	.438	C57033	—	—	—
*3-48	UNC	.0990	2	H2	1.813	.500	C57038	—	C55294	—
*3-56	UNF	.0990	2	H2	1.813	.500	C57041	—	—	—
4-40	UNC	.1120	2	H1	1.875	.563	C57047	—	—	—
4-40	UNC	.1120	2	H2	1.875	.563	C57048	C57604	C55296	C55374
4-48	UNF	.1120	2	H2	1.875	.563	C57051	—	—	—
5-40	UNC	.1250	2	H2	1.938	.625	C57062	C57606	C55298	C55376
6-32	UNC	.1380	2	H1	2.000	.688	C57069	—	—	—
6-32	UNC	.1380	2	H2	2.000	.688	C57070	C57608	C55299	—
6-32	UNC	.1380	2	H3	2.000	.688	C57072	C57609	C55300	C55378
6-32	UNC	.1380	2	H7	2.000	.688	C57074	—	—	—
6-40	UNF	.1380	2	H2	2.000	.688	C57076	—	C55302	—
8-32	UNC	.1640	2	H2	2.125	.750	C57083	C57610	C55303	—
8-32	UNC	.1640	2	H3	2.125	.750	C57085	C57611	C55304	C55380
8-32	UNC	.1640	2	H7	2.125	.750	C57087	—	C55305	—
8-36	UNF	.1640	2	H2	2.125	.750	C57089	—	C55306	—
10-24	UNC	.1900	2	H1	2.375	.875	C57094	—	—	—
10-24	UNC	.1900	2	H2	2.375	.875	C57095	—	C55307	—
10-24	UNC	.1900	2	H3	2.375	.875	C57097	C57001	C55308	C55382
10-24	UNC	.1900	2	H7	2.375	.875	C57099	—	C55309	—
10-32	UNF	.1900	2	H2	2.375	.875	C57102	—	C55311	—
10-32	UNF	.1900	2	H3	2.375	.875	C57104	C57002	C55310	C55383
10-32	UNF	.1900	2	H7	2.375	.875	C57106	—	C55346	—
12-24	UNC	.2160	2	H3	2.375	.938	C57112	C57616	C55312	C55384
12-28	UNF	.2160	2	H3	2.375	.938	C57114	—	C55313	—
1/4-20	UNC	.2500	2	H1	2.500	1.000	C57127	—	C55348	—
1/4-20	UNC	.2500	2	H2	2.500	1.000	C57128	C57618	C55315	—
1/4-20	UNC	.2500	2	H3	2.500	1.000	C57129	C57619	C55316	—
1/4-20	UNC	.2500	3	H3	2.500	1.000	C57130	C57620	—	C55386
1/4-20	UNC	.2500	2	H5	2.500	1.000	C57132	—	C55317	—
1/4-20	UNC	.2500	3	H5	2.500	1.000	C57133	—	—	—
1/4-20	UNC	.2500	2	H11	2.500	1.000	C57135	—	—	—
1/4-28	UNF	.2500	2	H2	2.500	1.000	C57137	—	—	—

* #0 - #3: 302 blank style.

continued on next page

tap size and pitch d ₁	thread form	decimal equiv	no. of flutes	H- limit	overall length L (in)	thread length l (in)	order number			
							1011 Bright	1011SO Black Oxide	1011TN TiN	1011TC TiCN
1/4-28	UNF	.2500	3	H2	2.500	1.000	C57138	—	—	C55387
1/4-28	UNF	.2500	2	H3	2.500	1.000	C57139	C57622	C55318	—
5/16-18	UNC	.3125	2	H1	2.719	1.125	C57149	—	—	—
5/16-18	UNC	.3125	2	H2	2.719	1.125	C57150	—	C55319	—
5/16-18	UNC	.3125	2	H3	2.719	1.125	C57151	C57624	C55320	—
5/16-18	UNC	.3125	3	H3	2.719	1.125	C57152	C57625	C55321	C55388
5/16-18	UNC	.3125	2	H5	2.719	1.125	C57154	—	C55354	—
5/16-18	UNC	.3125	3	H5	2.719	1.125	C57155	—	C55355	—
5/16-24	UNF	.3125	2	H1	2.719	1.125	C57157	—	—	—
5/16-24	UNF	.3125	2	H3	2.719	1.125	C57160	C57626	C55322	—
5/16-24	UNF	.3125	3	H4	2.719	1.125	C57164	—	—	C55389
3/8-16	UNC	.3750	3	H2	2.938	1.250	C57175	—	C55323	—
3/8-16	UNC	.3750	3	H3	2.938	1.250	C57176	C57628	C55324	C55390
3/8-16	UNC	.3750	3	H5	2.938	1.250	C57177	—	C55325	—
3/8-24	UNF	.3750	3	H1	2.938	1.250	C57179	—	—	—
3/8-24	UNF	.3750	3	H2	2.938	1.250	C57180	—	—	—
3/8-24	UNF	.3750	3	H3	2.938	1.250	C57181	C57630	C55326	C55391
3/8-24	UNF	.3750	3	H4	2.938	1.250	C57182	—	—	—
7/16-14	UNC	.4375	3	H2	3.156	1.438	C57191	—	—	—
7/16-14	UNC	.4375	3	H3	3.156	1.438	C57192	C57632	C55328	—
7/16-14	UNC	.4375	3	H5	3.156	1.438	C57193	—	—	—
7/16-20	UNF	.4375	3	H3	3.156	1.438	C57195	—	C55330	C55392
7/16-20	UNF	.4375	3	H5	3.156	1.438	C57196	—	—	—
1/2-13	UNC	.5000	3	H2	3.375	1.656	C57214	—	—	—
1/2-13	UNC	.5000	3	H3	3.375	1.656	C57215	C57636	C55332	C55394
1/2-13	UNC	.5000	3	H5	3.375	1.656	C57216	—	C55333	—
1/2-20	UNF	.5000	3	H3	3.375	1.656	C57220	C57638	C55334	C55395
5/8-11	UNC	.6250	3	H3	3.813	1.813	C57230	C57640	C55336	C55396
5/8-11	UNC	.6250	3	H5	3.813	1.813	C57232	—	—	—
5/8-18	UNF	.6250	3	H3	3.813	1.813	C57555	C57642	—	—
3/4-10	UNC	.7500	3	H3	4.250	2.000	C57246	C57644	C55338	C55398
3/4-10	UNC	.7500	3	H5	4.250	2.000	C57247	—	—	—
3/4-16	UNF	.7500	3	H3	4.250	2.000	C60999	—	—	—

Spiral Point
High Speed Steel

continued on next page

Material Reference	Steel (HRc)				Stainless Steel			Cast Iron (HRc)		Aluminum and Non-Ferrous	Hi-Temp Alloy		Hardened Steel (HRc)
	Low Carbon		Alloy		Austenitic	Martensitic	PH	Gray	Nodular		Ni, Co, Fe Based Super Alloy	Titanium	
	Hardness	13-38	>38	16-38	> 38	300 Series	400 series		18-22	22-32			>45
TiN	◆		◆		◆					☆			
TiCN	☆		☆		☆			◆					

☆ = Best Performance ◆ = Acceptable

Threading

General Purpose
Metric



Styles: **1011**, **1011TN**, **1011TC** (cont'd)

Note
Tapping Speeds and Feeds see
Technical section.



Surface
Treatment

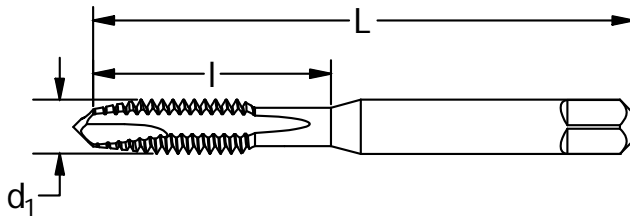

Feature:

Thru hole application in a variety of materials.

Spiral Point

High Speed Steel

tap size and pitch d ₁	decimal equiv	no. of flutes	D- limit	overall length L		thread length l		order number		
				in	mm	in	mm	1011 Bright	1011TN TiN	1011TC TiCN
*M1.6 x 0.35	.0630	2	D3	1.750	44.45	.313	11.11	C57015	—	—
*M1.8 x 0.35	.0709	2	D3	1.750	44.45	.375	11.11	C57019	—	—
*M2 x 0.4	.0787	2	D3	1.750	44.45	.438	11.11	C57027	—	—
*M2.2 x 0.45	.0866	2	D3	1.750	44.45	.438	11.11	C57036	—	—
*M2.5 x 0.45	.0984	2	D3	1.813	46.04	.500	12.70	C57044	—	—
M3 x 0.5	.1181	2	D3	1.938	49.21	.625	15.88	C57055	C55360	C55415
M3.5 x 0.6	.1378	2	D4	2.000	50.80	.688	17.46	C57067	—	—
M4 x 0.7	.1575	2	D4	2.125	53.98	.750	19.05	C57080	C55361	C55416
M4.5 x 0.75	.1771	2	D4	2.375	60.33	.875	22.23	C57092	—	—
M5 x 0.8	.1968	2	D4	2.375	60.33	.875	22.23	C57110	—	C55417
M6 x 1	.2362	2	D5	2.500	63.50	1.000	25.40	C57118	C55362	C55418
M7 x 1	.2756	2	D5	2.719	69.06	1.125	28.58	C57146	—	—
M8 x 1	.3150	2	D5	2.719	69.06	1.125	28.58	C57168	—	—
M8 x 1.25	.3150	2	D5	2.719	69.06	1.125	28.58	C57171	C55363	C55419
M10 x 1.25	.3937	3	D5	2.938	74.61	1.250	31.75	C57187	—	—
M10 x 1.5	.3937	3	D6	2.938	74.61	1.250	31.75	C57189	C55364	C55420
M12 x 1.25	.4724	3	D5	3.375	85.73	1.656	42.07	C57199	—	—
M12 x 1.75	.4724	3	D6	3.375	85.73	1.656	42.07	C57203	C55365	C55421
M14 x 1.5	.5512	3	D6	3.594	91.28	1.656	42.07	C57226	—	—
M14 x 2	.5512	3	D7	3.594	91.28	1.656	42.07	C57228	—	—
M16 x 1.5	.6299	3	D6	3.813	96.84	1.813	46.04	C57234	—	—
M16 x 2	.6299	3	D7	3.813	96.84	1.813	46.04	C57236	—	—
M20 x 2.5	.7874	3	D7	3.813	96.84	2.000	46.04	C57253	—	—

*M1.6-M2.5: 302 blank style

Material Reference	Steel (HRc)				Stainless Steel			Cast Iron (HRc)		Aluminum and Non-Ferrous	Hi-Temp Alloy		Hardened Steel (HRc)
	Low Carbon		Alloy		Austenitic	Martensitic	PH	Gray	Nodular		Ni, Co, Fe Based Super Alloy	Titanium	
	Hardness	13-38	>38	16-38	> 38	300 Series	400 series		18-22	22-32			>45
TiN	◆		◆		◆					☆			
TiCN	☆		☆		☆			◆					

☆ = Best Performance ◆ = Acceptable





Styles: **1053**

Low Shear

Note

Tapping Speeds and Feeds see Technical section.



Surface Treatment

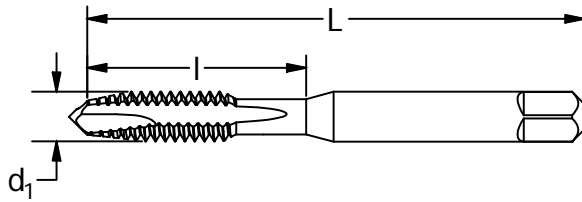

Feature:

Thru hole applications in iron and harder steels.

tap size and pitch d_1	thread form	decimal equiv.	number of flutes	H-limit	overall length L (in)	thread length I (in)	order number 1053
4-40	UNC	.1120	2	H2	1.875	.563	C57324
5-40	UNC	.1250	2	H2	1.938	.625	C57338
6-32	UNC	.1380	2	H3	2.000	.688	C57348
8-32	UNC	.1640	2	H3	2.125	.750	C57361
10-24	UNF	.1900	2	H3	2.375	.875	C57373
10-32	UNC	.1900	2	H3	2.375	.875	C57380
12-24	UNC	.2160	2	H3	2.375	.938	C57388
1/4-20	UNC	.2500	2	H1	2.500	1.000	C57403
1/4-20	UNC	.2500	2	H2	2.500	1.000	C57404
1/4-20	UNC	.2500	2	H3	2.500	1.000	C57406
1/4-20	UNC	.2500	2	H11	2.500	1.000	C57411
1/4-28	UNF	.2500	2	H3	2.500	1.000	C57415
5/16-18	UNC	.3125	2	H3	2.719	1.125	C57428
5/16-24	UNF	.3125	2	H3	2.719	1.125	C57437
3/8-16	UNC	.3750	3	H3	2.938	1.250	C57452
7/16-14	UNC	.4375	3	H3	3.156	1.438	C57469
1/2-13	UNC	.5000	3	H3	3.375	1.656	C57492
5/8-11	UNC	.6250	3	H3	3.813	1.813	C57507

Spiral Point
High Speed Steel

Material Reference	Steel (HRC)				Stainless Steel			Cast Iron (HRC)		Aluminum and Non-Ferrous	Hi-Temp Alloy		Hardened Steel (HRC)
	Low Carbon		Alloy		Austenitic	Martensitic	PH	Gray	Nodular		Ni, Co, Fe Based Super Alloy	Titanium	
Hardness	13-38	>38	16-38	> 38	300 Series	400 series		18-22	22-32				>45
Bright	☆		☆					☆	◆				

☆ = Best Performance ◆ = Acceptable



Bottoming

Styles: **1012**

Note
Tapping Speeds and Feeds see Technical section.

HSS
302A
Spiral Point
Blind Holes
Bottom 1-2
Surface Treatment
Bright

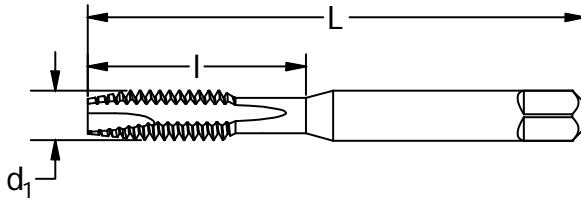

tap size and pitch d_1	thread form	decimal equiv.	number of flutes	H-limit	overall length L (in)	thread length l (in)	order number
*0-80	UNF	.0600	2	H2	1.625	.313	1012 C57012
*2-56	UNC	.0860	2	H2	1.750	.438	C57032
4-40	UNC	.1120	2	H2	1.875	.563	C57049
5-40	UNC	.1250	2	H2	1.938	.625	C57063
6-32	UNC	.1380	2	H3	2.000	.688	C57073
8-32	UNC	.1640	2	H3	2.125	.750	C57086
10-24	UNC	.1900	2	H3	2.375	.875	C57098
10-32	UNF	.1900	2	H3	2.375	.875	C57105
1/4-20	UNC	.2500	2	H3	2.500	1.000	C57131
1/4-28	UNF	.2500	2	H3	2.500	1.000	C57140
5/16-18	UNC	.3125	3	H3	2.719	1.125	C57153
5/16-24	UNF	.3125	2	H3	2.719	1.125	C57162

*#0-#2: 302 blank style

Spiral Point

High Speed Steel

6" Extended Length

Styles: **1011E**

Note
Tapping Speeds and Feeds see Technical section.

HSS
303-A Extended Length
Spiral Point
Thru Holes
Plug 3-5
Surface Treatment
Bright

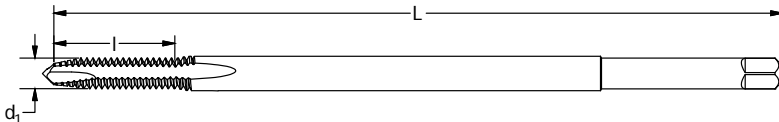

Feature:

Extended length for long reach applications.

tap size and pitch d_1	thread form	decimal equiv.	number of flutes	H-limit	overall length L (in)	thread length l (in)	order number
#8-32	UNC	.1640	2	H3	6.0000	.7500	1011E C59106
#10-24	UNC	.1900	2	H3	6.0000	.8750	C59109
#10-32	UNF	.1900	2	H3	6.0000	.8750	C59110
1/4-20	UNC	.2500	2	H3	6.0000	1.0000	C59117
1/4-28	UNF	.2500	2	H3	6.0000	1.0000	C59118
5/16-18	UNC	.3125	2	H3	6.0000	1.1250	C59121
5/16-24	UNF	.3125	2	H3	6.0000	1.1250	C59122
3/8-16	UNC	.3750	3	H3	6.0000	1.2500	C59126
3/8-24	UNF	.3750	3	H3	6.0000	1.2500	C59127

Material Reference	Steel (HRC)				Stainless Steel			Cast Iron (HRC)		Aluminum and Non-Ferrous	Hi-Temp Alloy		Hardened Steel (HRC)
	Low Carbon		Alloy		Austenitic	Martensitic	PH	Gray	Nodular		Ni, Co, Fe Based Super Alloy	Titanium	
	Hardness	13-38	>38	16-38	> 38	300 Series	400 series		18-22	22-32			>45
1012 Bright	☆							◆		☆			
1011E Bright	☆		☆					☆		◆			

☆ = Best Performance ◆ = Acceptable

Style: **T-101**

Note
Tapping Speeds and Feeds see
Technical section.



Surface
Treatment

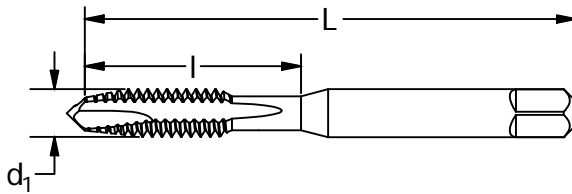

Feature:

Premium steel substrate for steels and stainless.

tap size and pitch d_1	thread form	decimal equiv.	number of flutes	H-Limit	overall length L (in)	thread length I (in)	order no. T-101
4-40	UNC	.1120	2	H2	1.875	.563	C27689
6-32	UNC	.1380	2	H3	2.000	.688	C27696
8-32	UNC	.1640	3	H3	2.125	.750	C27697
8-32	UNC	.1640	3	H5	2.125	.750	C27720
10-24	UNC	.1900	3	H3	2.375	.875	C27698
10-32	UNF	.1900	3	H3	2.375	.875	C27699
1/4-20	UNC	.2500	3	H3	2.500	1.000	C27700
1/4-20	UNC	.2500	3	H5	2.500	1.000	C27723
5/16-18	UNC	.3125	3	H3	2.719	1.125	C27702
5/16-24	UNF	.3125	3	H3	2.719	1.125	C27703
3/8-16	UNC	.3750	3	H3	2.938	1.250	C27704
1/2-13	UNC	.5000	3	H3	3.375	1.656	C27708

Spiral Point

Premium High Speed Steel

Made To Order
Taps Available

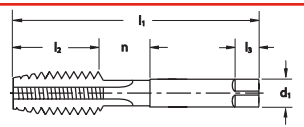

Material Reference	Steel (HRc)		Stainless Steel			Cast Iron (HRc)		Aluminum and Non-Ferrous	Hi-Temp Alloy		Hardened Steel (HRc)
	Low Carbon	Alloy	Austenitic	Martensitic	PH	Gray	Nodular		Ni, Co, Fe Based Super Alloy	Titanium	
Hardness	13-38	>38	16-38	> 38	300 Series	400 series	PH	18-22	22-32		>45
Black Oxide	☆		☆		☆	☆	◆	◆	◆		

☆ = Best Performance ◆ = Acceptable

Note
Tapping Speeds and Feeds see Technical section.

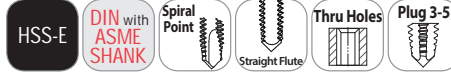

Surface Treatment

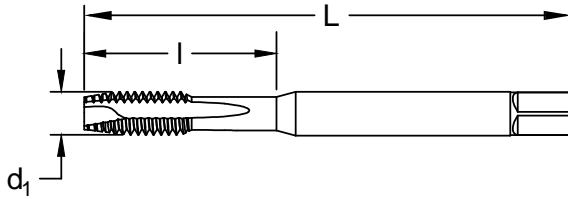

Feature:

Premium steel substrate, for use in a wide array of materials.

Spiral Point

Premium High Speed Steel

tap size and pitch d₁	thread form	decimal equiv.	no. of flutes	class of fit	shank diameter	overall length L (in)	thread length I (in)	order number	
								Black Oxide PRO-961SP	TiAlN PRO-861SP
2-56	UNC	0.0860	3	2B	0.141	1.772	0.551	C96101	C86101
3-48	UNC	0.0990	3	2B	0.141	1.969	0.591	C96102	C86102
4-40	UNC	0.1120	3	2B	0.141	2.205	0.669	C96103	C86103
4-48	UNF	0.1120	3	2B	0.141	2.205	0.669	C96104	C86104
5-40	UNC	0.1250	3	2B	0.141	2.205	0.748	C96105	C86105
6-32	UNC	0.1380	3	2B	0.141	2.205	0.787	C96106	C86106
6-40	UNF	0.1380	3	2B	0.141	2.205	0.787	C96107	C86107
8-32	UNC	0.1640	3	2B	0.168	2.480	0.827	C96108	C86108
8-36	UNF	0.1640	3	2B	0.168	2.480	0.827	C96109	C86109
10-24	UNC	0.1900	3	2B	0.194	2.756	1.024	C96110	C86110
10-32	UNF	0.1900	3	2B	0.194	2.756	1.024	C96111	C86111
12-24	UNC	0.2160	3	2B	0.220	3.150	1.063	C96112	C86112
12-28	UNF	0.2160	3	2B	0.220	3.150	1.063	C96113	C86113
1/4-20	UNC	0.2500	3	2B	0.255	3.150	1.260	C96114	C86114
1/4-28	UNF	0.2500	3	2B	0.255	3.150	1.260	C96115	C86115
5/16-18	UNC	0.3125	3	2B	0.318	3.543	1.378	C96116	C86116
5/16-24	UNF	0.3125	3	2B	0.318	3.543	1.378	C96117	C86117
3/8-16	UNC	0.3750	3	2B	0.381	3.937	1.732	C96118	C86118
3/8-24	UNF	0.3750	3	2B	0.381	3.937	1.732	C96119	C86119
7/16-14	UNC	0.4375	3	2B	0.323	3.937	1.614	C96120	C86120
7/16-20	UNF	0.4375	3	2B	0.323	3.937	1.614	C96121	C86121
1/2-13	UNC	0.5000	3	2B	0.367	4.331	1.535	C96122	C86122
1/2-20	UNF	0.5000	3	2B	0.367	4.331	1.535	C96123	C86123
9/16-12	UNC	0.5625	3	2B	0.429	4.331	1.772	C96124	C86124
9/16-18	UNF	0.5625	3	2B	0.429	4.331	1.772	C96125	C86125
5/8-11	UNC	0.6250	3	2B	0.480	4.331	2.087	C96126	C86126
5/8-18	UNF	0.6250	3	2B	0.480	4.331	2.087	C96127	C86127
3/4-10	UNC	0.7500	4	2B	0.590	4.921	2.205	C96128	C86128
3/4-16	UNF	0.7500	4	2B	0.590	4.921	2.205	C96129	C86129
7/8-9	UNC	0.8750	4	2B	0.697	5.512	2.362	C96130	C86130
7/8-14	UNF	0.8750	4	2B	0.697	5.512	2.362	C96131	C86131
1-8	UNC	1.0000	4	2B	0.800	6.299	2.520	C96132	C86132
1-12	UNF	1.0000	4	2B	0.800	6.299	2.520	C96133	C86133

continued on next page

tap size and pitch d ₁	thread form	decimal equiv.	no. of flutes	class of fit	shank diameter		overall length L		thread length l		order number	
					in	mm	in	mm	in	mm	Black Oxide PRO-961SP	TiAlN PRO-861SP
M2.5x0.45	M	0.0866	3	6H	0.141	3.58	2.205	56	0.748	19	C96152	C86152
M3x0.5	M	0.1181	3	6H	0.141	3.58	2.205	56	0.748	19	C96134	C86134
M3.5x0.6	M	0.1378	3	6H	0.141	3.58	2.205	56	0.787	20	C96135	C86135
M4x0.7	M	0.1575	3	6H	0.168	4.27	2.480	63	0.827	21	C96136	C86136
M5x0.8	M	0.1969	3	6H	0.194	4.93	2.756	70	1.024	26	C96137	C86137
M6x1	M	0.2362	3	6H	0.255	6.48	3.150	80	1.260	32	C96138	C86138
M7x1	M	0.2756	3	6H	0.318	8.08	3.150	80	1.181	30	C96139	C86139
M8x1	M	0.3150	3	6H	0.318	8.08	3.543	90	1.378	35	C96140	C86140
M8x1.25	M	0.3150	3	6H	0.318	8.08	3.543	90	1.378	35	C96141	C86141
M10x1.25	M	0.3937	3	6H	0.381	9.68	3.937	100	1.575	40	C96142	C86142
M10x1.5	M	0.3937	3	6H	0.381	9.68	3.937	100	1.575	40	C96143	C86143
M12x1.25	M	0.4724	3	6H	0.367	9.32	4.331	110	1.575	40	C96144	C86144
M12x1.75	M	0.4724	3	6H	0.367	9.32	4.331	110	1.575	40	C96145	C86145
M14x1.5	M	0.5512	3	6H	0.429	10.9	4.331	110	1.772	45	C96146	C86146
M14x2	M	0.5512	3	6H	0.429	10.9	4.331	110	1.772	45	C96147	C86147
M16x1.5	M	0.6299	3	6H	0.480	12.19	4.331	110	2.087	53	C96148	C86148
M16x2	M	0.6299	3	6H	0.480	12.19	4.331	110	2.087	53	C96149	C86149
M18x1.5	M	0.7087	4	6H	0.542	13.77	4.921	125	2.165	55	C96150	C86150
M18x2.5	M	0.7087	4	6H	0.542	13.77	4.921	125	2.165	55	C96151	C86151

Spiral Point
Premium High Speed Steel

Material Reference	Steel (HRC)				Stainless Steel			Cast Iron (HRC)		Aluminum and Non-Ferrous	Hi-Temp Alloy		Hardened Steel (HRC)
	Low Carbon		Alloy		Austenitic	Martensitic	PH	Gray	Nodular		Ni, Co, Fe Based Super Alloy	Titanium	
Hardness	13-38	>38	16-38	> 38	300 Series	400 series		18-22	22-32				>45
Black Oxide	◆		◆		◆	◆		◆	◆				
TiAlN	☆		☆		☆	☆		☆	☆				

☆ = Best Performance ◆ = Acceptable

Note
Tapping Speeds and Feeds see Technical section.

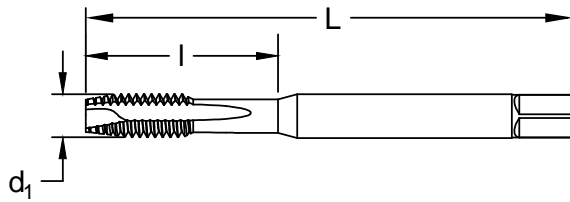

Feature:

Premium steel substrate, for use in a wide array of materials.

Spiral Point

Premium High Speed Steel

tap size and pitch d₁	thread form	decimal equiv.	no. of flutes	class of fit	shank diameter	overall length L (in)	thread length I (in)	order number	
								Black Oxide PER-862SP	Hardlube PER-960SP
2-56	UNC	0.0860	3	2B	0.141	1.772	0.551	C86201	C96001
3-48	UNC	0.0990	3	2B	0.141	1.969	0.591	C86202	C96002
4-40	UNC	0.1120	3	2B	0.141	2.205	0.669	C86203	C96003
4-48	UNF	0.1120	3	2B	0.141	2.205	0.669	C86204	C96004
5-40	UNC	0.1250	3	2B	0.141	2.205	0.748	C86205	C96005
6-32	UNC	0.1380	3	2B	0.141	2.205	0.787	C86206	C96006
6-40	UNF	0.1380	3	2B	0.141	2.205	0.787	C86207	C96007
8-32	UNC	0.1640	3	2B	0.168	2.480	0.827	C86208	C96008
8-36	UNF	0.1640	3	2B	0.168	2.480	0.827	C86209	C96009
10-24	UNC	0.1900	3	2B	0.194	2.756	1.024	C86210	C96010
10-32	UNF	0.1900	3	2B	0.194	2.756	1.024	C86211	C96011
12-24	UNC	0.2160	3	2B	0.220	3.150	1.063	C86212	C96012
12-28	UNF	0.2160	3	2B	0.220	3.150	1.063	C86213	C96013
1/4-20	UNC	0.2500	3	2B	0.255	3.150	1.260	C86214	C96014
1/4-28	UNF	0.2500	3	2B	0.255	3.150	1.260	C86215	C96015
5/16-18	UNC	0.3125	3	2B	0.318	3.543	1.378	C86216	C96016
5/16-24	UNF	0.3125	3	2B	0.318	3.543	1.378	C86217	C96017
3/8-16	UNC	0.3750	3	2B	0.381	3.937	1.732	C86218	C96018
3/8-24	UNF	0.3750	3	2B	0.381	3.937	1.732	C86219	C96019
7/16-14	UNC	0.4375	3	2B	0.323	3.937	1.614	C86220	C96020
7/16-20	UNF	0.4375	3	2B	0.323	3.937	1.614	C86221	C96021
1/2-13	UNC	0.5000	3	2B	0.367	4.331	1.535	C86222	C96022
1/2-20	UNF	0.5000	3	2B	0.367	4.331	1.535	C86223	C96023
9/16-12	UNC	0.5625	3	2B	0.429	4.331	1.772	C86224	C96024
9/16-18	UNF	0.5625	3	2B	0.429	4.331	1.772	C86225	C96025
5/8-11	UNC	0.6250	3	2B	0.480	4.331	2.087	C86226	C96026
5/8-18	UNF	0.6250	3	2B	0.480	4.331	2.087	C86227	C96027
3/4-10	UNC	0.7500	4	2B	0.590	4.921	2.205	C86228	C96028
3/4-16	UNF	0.7500	4	2B	0.590	4.921	2.205	C86229	C96029
7/8-9	UNC	0.8750	4	2B	0.697	5.512	2.362	C86230	C96030
7/8-14	UNF	0.8750	4	2B	0.697	5.512	2.362	C86231	C96031
1-8	UNC	1.0000	4	2B	0.800	6.299	2.520	C86232	C96032
1-12	UNF	1.0000	4	2B	0.800	6.299	2.520	C86233	C96033

continued on next page

Styles: PER-862SP and PER-960SP (continued)

tap size and pitch d₁	thread form	decimal equiv.	no. of flutes	class of fit	shank diameter		overall length L		thread length l		order number	
					in	mm	in	mm	in	mm	Black Oxide PER-862SP	Hardlube PER-960SP
M2.5x.045	M	0.0866	3	6H	0.141	3.58	2.205	56	0.748	19	C86252	C96052
M3x0.5	M	0.1181	3	6H	0.141	3.58	2.205	56	0.748	19	C86234	C96034
M3.5x0.6	M	0.1378	3	6H	0.141	3.58	2.205	56	0.787	20	C86235	C96035
M4x0.7	M	0.1575	3	6H	0.168	4.27	2.480	63	0.827	21	C86236	C96036
M5x0.8	M	0.1969	3	6H	0.194	4.93	2.756	70	1.024	26	C86237	C96037
M6x1	M	0.2362	3	6H	0.255	6.48	3.150	80	1.260	32	C86238	C96038
M7x1	M	0.2756	3	6H	0.318	8.08	3.150	80	1.181	30	C86239	C96039
M8x1	M	0.3150	3	6H	0.318	8.08	3.543	90	1.378	35	C86240	C96040
M8x1.25	M	0.3150	3	6H	0.318	8.08	3.543	90	1.378	35	C86241	C96041
M10x1.25	M	0.3937	3	6H	0.381	9.68	3.937	100	1.575	40	C86242	C96042
M10x1.5	M	0.3937	3	6H	0.381	9.68	3.937	100	1.575	40	C86243	C96043
M12x1.25	M	0.4724	3	6H	0.367	9.32	4.331	110	1.575	40	C86244	C96044
M12x1.75	M	0.4724	3	6H	0.367	9.32	4.331	110	1.575	40	C86245	C96045
M14x1.5	M	0.5512	3	6H	0.429	10.9	4.331	110	1.772	45	C86246	C96046
M14x2	M	0.5512	3	6H	0.429	10.9	4.331	110	1.772	45	C86247	C96047
M16x1.5	M	0.6299	3	6H	0.480	12.19	4.331	110	2.087	53	C86248	C96048
M16x2	M	0.6299	3	6H	0.480	12.19	4.331	110	2.087	53	C86249	C96049
M18x1.5	M	0.7087	4	6H	0.542	13.77	4.921	125	2.165	55	C86250	C96050
M18x2.5	M	0.7087	4	6H	0.542	13.77	4.921	125	2.165	55	C86251	C96051

Spiral Point
Premium High Speed Steel

Material Reference	Steel (HRC)				Stainless Steel			Cast Iron (HRC)		Aluminum and Non-Ferrous	Hi-Temp Alloy		Hardened Steel (HRC)
	Low Carbon		Alloy		Austenitic	Martensitic	PH	Gray	Nodular		Ni, Co, Fe Based Super Alloy	Titanium	
Hardness	13-38	>38	16-38	> 38	300 Series	400 series		18-22	22-32			>45	
Black Oxide	◆		◆		◆	◆		◆	◆				
Hardlube	☆	◆	☆	◆	☆	☆	☆	☆	☆				

☆ = Best Performance ◆ = Acceptable

Threading

General Purpose - Inch High-Spiral



Styles: **1093, 1093-TN, 1094, 1094-TN**

Note
Tapping Speeds and Feeds see
Technical section.

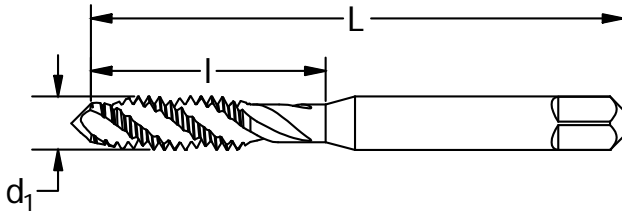
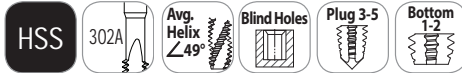

Spiral Flute

High Speed Steel

order number

tap size and pitch d_1	thread form	decimal equiv.	no. of flutes	H- limit	overall length		thread length		order number			
					L (in)	I (in)	1093 Bright	1093-TN TiN	1094 Bright	1094-TN TiN		
4-40	UNC	.1120	2	H2	1.875	.563	C58515	—	C58516	C55566		
6-32	UNC	.1380	2	H3	2.000	.688	C58532	C55571	C58533	C55570		
8-32	UNC	.1640	3	H3	2.125	.750	C58538	C55573	C58539	C55572		
10-24	UNC	.1900	3	H3	2.375	.875	C58544	C55575	C58545	—		
10-32	UNF	.1900	3	H3	2.375	.875	C58546	C55577	C58547	C55576		
1/4-20	UNC	.2500	3	H3	2.500	1.000	C58562	—	C58563	—		
1/4-28	UNF	.2500	3	H3	2.500	1.000	C58564	—	C58565	—		
5/16-18	UNC	.3125	3	H3	2.719	1.125	C58570	—	C58571	—		
5/16-24	UNF	.3125	3	H3	2.719	1.125	C58572	—	C58573	—		
3/8-16	UNC	.3750	3	H3	2.938	1.250	C58581	—	C58582	—		
3/8-24	UNF	.3750	3	H3	2.938	1.250	C58583	—	C58584	—		
1/2-13	UNC	.5000	3	H3	3.375	1.656	C58613	—	C58614	—		
1/2-20	UNF	.5000	3	H3	3.375	1.656	C58615	—	C58616	—		

General Purpose - Metric High-Spiral

Styles: **1093, 1093-TC, 1094, 1094-TC**

tap size and pitch d_1	decimal equiv.	no. of flutes	D- limit	overall length		thread length		order number			
				in	mm	in	mm	1093 Bright	1093-TC TiCN	1094 Bright	1094-TC TiCN
M3 x 0.5	.1181	2	D3	1.938	49.21	.625	15.88	C58800	—	C58801	C58901
M4 x 0.7	.1575	3	D4	2.125	53.98	.750	19.05	C58804	C58904	C58805	C58905
M5 x 0.8	.1969	3	D4	2.375	60.33	.875	22.23	C58806	C58906	C58807	C58907
M6 x 1.0	.2362	3	D5	2.500	63.50	1.000	25.40	C58808	C58908	C58809	C58909
M8 x 1.25	.3150	3	D5	2.719	69.06	1.125	28.58	C58810	C58910	C58811	C58911
M10 x 1.5	.3937	3	D8	2.938	74.61	1.250	31.75	C58812	C58912	C58813	C58913
M12x1.75	.4724	3	D6	3.375	85.73	1.656	42.07	—	—	C58815	—

Material Reference	Steel (HRC)				Stainless Steel			Cast Iron (HRC)		Aluminum and Non-Ferrous	Hi-Temp Alloy		Hardened Steel (HRC)
	Low Carbon		Alloy		Austenitic	Martensitic	PH	Gray	Nodular		Ni, Co, Fe Based Super Alloy	Titanium	
	Hardness	13-38	>38	16-38	> 38	300 Series	400 series		18-22	22-32			>45
	Bright	◆		◆							☆		
TiN	☆		☆		☆								
TiCN	☆		☆		☆					☆			

☆ = Best Performance ◆ = Acceptable



Styles: 1095, 1096
Heavy Duty CNC
Note

Tapping Speeds and Feeds see Technical section.

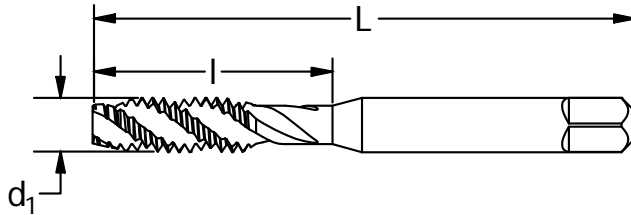

tap size and pitch d_1	thread form	decimal equiv.	no of flutes	H- limit	overall length L (in)	thread length l (in)	order number	
							1095 Plug	1096 Bottoming
6-32	UNC	.1380	2	H3	2.000	.688	C58432	C58433
8-32	UNC	.1640	3	H3	2.125	.750	C58434	C58435
10-24	UNC	.1900	3	H3	2.375	.875	C58436	C58437
10-32	UNF	.1900	3	H3	2.375	.875	C58438	C58439
1/4-20	UNC	.2500	3	H3	2.500	1.000	C58440	C58441
1/4-28	UNF	.2500	3	H3	2.500	1.000	C58442	C58443
5/16-18	UNC	.3125	3	H3	2.719	1.125	C58444	C58445
5/16-24	UNF	.3125	3	H3	2.719	1.125	—	C58447
3/8-16	UNC	.3750	3	H3	2.938	1.250	C58448	C58449
3/8-24	UNF	.3750	3	H3	2.938	1.250	C58450	C58451
1/2-13	UNC	.5000	3	H3	3.375	1.656	C58452	C58453

Spiral Flute
High Speed Steel

Material Reference	Steel (HRC)				Stainless Steel			Cast Iron (HRC)		Aluminum and Non-Ferrous	Hi-Temp Alloy		Hardened Steel (HRC)
	Low Carbon		Alloy		Austenitic	Martensitic	PH	Gray	Nodular		Ni, Co, Fe Based Super Alloy	Titanium	
Hardness	13-38	>38	16-38	> 38	300 Series	400 series		18-22	22-32				>45
Black Oxide	☆		☆					☆	◆				

☆ = Best Performance ◆ = Acceptable

Note
Tapping Speeds and Feeds see
Technical section.



Surface Treatment

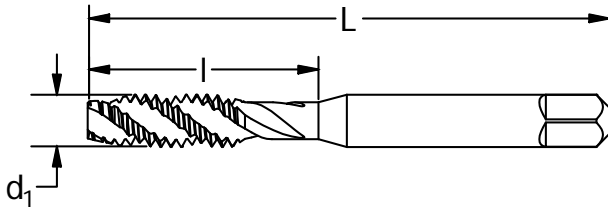

Spiral Flute

High Speed Steel

tap size and pitch d_1	thread form	decimal equiv.	number of flutes	H-limit	overall length L (in)	thread length l (in)	order no. B-101
10-32	UNF	.1900	3	H3	2.375	.875	C27897
1/4-20	UNC	.2500	3	H3	2.500	1.000	C27898
1/4-20	UNC	.2500	3	H5	2.500	1.000	C27921
5/16-18	UNC	.3125	3	H3	2.719	1.125	C27900
5/16-18	UNC	.3125	3	H5	2.719	1.125	C27922
3/8-16	UNC	.3750	3	H3	2.938	1.250	C27902
3/8-16	UNC	.3750	3	H5	2.938	1.250	C27923
1/2-13	UNC	.5000	3	H3	3.375	1.656	C27906
1/2-13	UNC	.5000	3	H5	3.375	1.656	C27926
1/2-20	UNF	.5000	3	H5	3.375	1.656	C27927
5/8-11	UNC	.6250	4	H3	3.813	1.813	C27910
5/8-11	UNC	.6250	4	H5	3.813	1.813	C27928

tap size and pitch d_1	decimal equiv.	number of flutes	D-limit	overall length L		thread length l		order no. B-101
				in	mm	in	mm	
M4x0.7	.1575	3	D4	2.125	53.98	.750	19.05	C27930
M5x0.8	.1968	3	D4	2.375	60.33	.875	22.23	C27931
M6x1	.2362	3	D5	2.500	63.50	1.000	25.4	C27932
M8x1.25	.3150	3	D5	2.719	69.06	1.125	28.58	C27933
M10x1.5	.3937	3	D6	2.938	74.61	1.250	31.75	C27934
M12x1.75	.4724	3	D6	3.375	85.73	1.656	42.06	C27935

Made To Order
Taps Available

Material Reference	Steel (HRc)				Stainless Steel			Cast Iron (HRc)		Aluminum and Non-Ferrous	Hi-Temp Alloy		Hardened Steel (HRc)
	Low Carbon		Alloy		Austenitic	Martensitic	PH	Gray	Nodular		Ni, Co, Fe Based Super Alloy	Titanium	
Hardness	13-38	>38	16-38	> 38	300 Series	400 series		18-22	22-32				>45
Black Oxide	☆		☆		☆	☆	◆	◆	◆				

☆ = Best Performance ◆ = Acceptable

Note
Tapping Speeds and Feeds see Technical section.



Surface Treatment

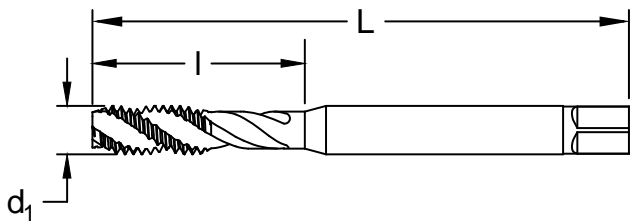

tap size and pitch d ₁ (in)	thread form	decimal equiv.	no. of flutes	class of fit	shank diameter	overall length L (in)	thread length I (in)	order number	
								Black Oxide PRO-981SF	TiAlN PRO-892SF
2-56	UNC	0.0860	3	2B	0.141	1.772	0.551	C98101	C89201
3-48	UNC	0.0990	3	2B	0.141	1.969	0.591	C98102	C89202
4-40	UNC	0.1120	3	2B	0.141	2.205	0.669	C98103	C89203
4-48	UNF	0.1120	3	2B	0.141	2.205	0.669	C98104	C89204
5-40	UNC	0.1250	3	2B	0.141	2.205	0.748	C98105	C89205
6-32	UNC	0.1380	3	2B	0.141	2.205	0.787	C98106	C89206
6-40	UNF	0.1380	3	2B	0.141	2.205	0.787	C98107	C89207
8-32	UNC	0.1640	3	2B	0.168	2.480	0.827	C98108	C89208
8-36	UNF	0.1640	3	2B	0.168	2.480	0.827	C98109	C89209
10-24	UNC	0.1900	3	2B	0.194	2.756	1.024	C98110	C89210
10-32	UNF	0.1900	3	2B	0.194	2.756	1.024	C98111	C89211
12-24	UNC	0.2160	3	2B	0.220	3.150	1.063	C98112	C89212
12-28	UNF	0.2160	3	2B	0.220	3.150	1.063	C98113	C89213
1/4-20	UNC	0.2500	3	2B	0.255	3.150	1.260	C98114	C89214
1/4-28	UNF	0.2500	3	2B	0.255	3.150	1.260	C98115	C89215
5/16-18	UNC	0.3125	3	2B	0.318	3.543	1.378	C98116	C89216
5/16-24	UNF	0.3125	3	2B	0.318	3.543	1.378	C98117	C89217
3/8-16	UNC	0.3750	3	2B	0.381	3.937	1.732	C98118	C89218
3/8-24	UNF	0.3750	3	2B	0.381	3.937	1.732	C98119	C89219
7/16-14	UNC	0.4375	3	2B	0.323	3.937	1.614	C98120	C89220
7/16-20	UNF	0.4375	3	2B	0.323	3.937	1.614	C98121	C89221
1/2-13	UNC	0.5000	3	2B	0.367	4.331	1.535	C98122	C89222
1/2-20	UNF	0.5000	3	2B	0.367	4.331	1.535	C98123	C89223
9/16-12	UNC	0.5625	4	2B	0.429	4.331	1.772	C98124	C89224
9/16-18	UNF	0.5625	4	2B	0.429	4.331	1.772	C98125	C89225
5/8-11	UNC	0.6250	4	2B	0.480	4.331	2.087	C98126	C89226
5/8-18	UNF	0.6250	4	2B	0.480	4.331	2.087	C98127	C89227
3/4-10	UNC	0.7500	4	2B	0.590	4.921	2.205	C98128	C89228
3/4-16	UNF	0.7500	4	2B	0.590	4.921	2.205	C98129	C89229
7/8-9	UNC	0.8750	4	2B	0.697	5.512	2.362	C98130	C89230
7/8-14	UNF	0.8750	4	2B	0.697	5.512	2.362	C98131	C89231
1-8	UNC	1.0000	4	2B	0.800	6.299	2.520	C98132	C89232
1-12	UNF	1.0000	4	2B	0.800	6.299	2.520	C98133	C89233

continued on next page

Material Reference	Steel (HRC)				Stainless Steel			Cast Iron (HRC)		Aluminum and Non-Ferrous	Hi-Temp Alloy		Hardened Steel (HRC)
	Low Carbon		Alloy		Austenitic	Martensitic	PH	Gray	Nodular		Ni, Co, Fe Based Super Alloy	Titanium	
	Hardness	13-38	>38	16-38	> 38	300 Series	400 series		18-22	22-32			>45
Black Oxide	◆		◆		◆	◆		◆	◆				
TiAlN	☆		☆		☆	☆		☆	☆				

☆ = Best Performance ◆ = Acceptable

Spiral Flute
Premium High Speed Steel



Spiral Flute

Premium High Speed Steel

tap size and pitch d ₁	thread form	decimal equiv.	no. of flutes	class of fit	shank diameter		overall length L		thread length I		order number	
					in	mm	in	mm	in	mm	Black Oxide PRO-981SF	TiAlN PRO-892SF
M3x0.5	M	0.1181	3	6H	0.141	3.58	2.205	56	0.748	19	C98134	C89234
M3.5x0.6	M	0.1378	3	6H	0.141	3.58	2.205	56	0.787	20	C98135	C89235
M4x0.7	M	0.1575	3	6H	0.168	4.27	2.480	63	0.827	21	C98136	C89236
M5x0.8	M	0.1969	3	6H	0.194	4.93	2.756	70	1.024	26	C98137	C89237
M6x1	M	0.2362	3	6H	0.255	6.48	3.150	80	1.260	32	C98138	C89238
M7x1	M	0.2756	3	6H	0.318	8.08	3.150	80	1.181	30	C98139	C89239
M8x1	M	0.3150	3	6H	0.318	8.08	3.543	90	1.378	35	C98140	C89240
M8x1.25	M	0.3150	3	6H	0.318	8.08	3.543	90	1.378	35	C98141	C89241
M10x1.25	M	0.3937	3	6H	0.381	9.68	3.937	100	1.575	40	C98142	C89242
M10x1.5	M	0.3937	3	6H	0.381	9.68	3.937	100	1.575	40	C98143	C89243
M12x1.25	M	0.4724	3	6H	0.367	9.32	4.331	110	1.575	40	C98144	C89244
M12x1.75	M	0.4724	3	6H	0.367	9.32	4.331	110	1.575	40	C98145	C89245
M14x1.5	M	0.5512	3	6H	0.429	10.9	4.331	110	1.772	45	C98146	C89246
M14x2	M	0.5512	3	6H	0.429	10.9	4.331	110	1.772	45	C98147	C89247
M16x1.5	M	0.6299	4	6H	0.480	12.19	4.331	110	2.087	53	C98148	C89248
M16x2	M	0.6299	4	6H	0.480	12.19	4.331	110	2.087	53	C98149	C89249
M18x1.5	M	0.7087	4	6H	0.542	13.77	4.921	125	2.165	55	C98150	C89250
M18x2.5	M	0.7087	4	6H	0.542	13.77	4.921	125	2.165	55	C98151	C89251
M20x2.5	M	0.7874	4	6H	0.650	16.51	5.512	140	2.480	63	C98152	C89252
M22x2.5	M	0.8661	4	6H	0.697	17.70	5.512	140	2.362	60	C98153	C89253
M24x3.0	M	0.9449	4	6H	0.760	19.30	6.299	160	2.598	66	C98154	C89254

Material Reference	Steel (HRc)				Stainless Steel			Cast Iron (HRc)		Aluminum and Non-Ferrous	Hi-Temp Alloy		Hardened Steel (HRc)
	Low Carbon		Alloy		Austenitic	Martensitic	PH	Gray	Nodular		Ni, Co, Fe Based Super Alloy	Titanium	
Hardness	13-38	>38	16-38	> 38	300 Series	400 series		18-22	22-32			>45	
Black Oxide	◆		◆		◆	◆		◆	◆				
TiAlN	☆		☆		☆	☆		☆	☆				

☆ = Best Performance ◆ = Acceptable



Styles: PER-893SF and PER-980SF

Note
Tapping Speeds and Feeds see Technical section.



Surface Treatment

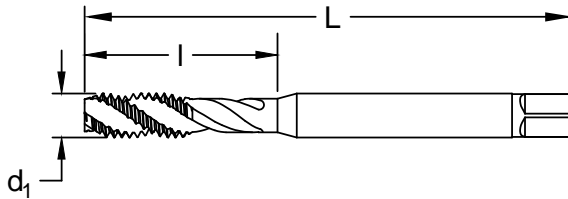

tap size and pitch d ₁ (in)	thread form	decimal equiv.	no. of flutes	class of fit	shank diameter	overall length L (in)	thread length I (in)	order number	
								Black Oxide PER-893SF	Hardlube PER-980SF
2-56	UNC	0.0860	3	2B	0.141	1.772	0.551	C89301	C98001
3-48	UNC	0.0990	3	2B	0.141	1.969	0.591	C89302	C98002
4-40	UNC	0.1120	3	2B	0.141	2.205	0.669	C89303	C98003
4-48	UNF	0.1120	3	2B	0.141	2.205	0.669	C89304	C98004
5-40	UNC	0.1250	3	2B	0.141	2.205	0.748	C89305	C98005
6-32	UNC	0.1380	3	2B	0.141	2.205	0.787	C89306	C98006
6-40	UNF	0.1380	3	2B	0.141	2.205	0.787	C89307	C98007
8-32	UNC	0.1640	3	2B	0.168	2.480	0.827	C89308	C98008
8-36	UNF	0.1640	3	2B	0.168	2.480	0.827	C89309	C98009
10-24	UNC	0.1900	3	2B	0.194	2.756	1.024	C89310	C98010
10-32	UNF	0.1900	3	2B	0.194	2.756	1.024	C89311	C98011
12-24	UNC	0.2160	3	2B	0.220	3.150	1.063	C89312	C98012
12-28	UNF	0.2160	3	2B	0.220	3.150	1.063	C89313	C98013
1/4-20	UNC	0.2500	3	2B	0.255	3.150	1.260	C89314	C98014
1/4-28	UNF	0.2500	3	2B	0.255	3.150	1.260	C89315	C98015
5/16-18	UNC	0.3125	3	2B	0.318	3.543	1.378	C89316	C98016
5/16-24	UNF	0.3125	3	2B	0.318	3.543	1.378	C89317	C98017
3/8-16	UNC	0.3750	3	2B	0.381	3.937	1.732	C89318	C98018
3/8-24	UNF	0.3750	3	2B	0.381	3.937	1.732	C89319	C98019
7/16-14	UNC	0.4375	3	2B	0.323	3.937	1.614	C89320	C98020
7/16-20	UNF	0.4375	3	2B	0.323	3.937	1.614	C89321	C98021
1/2-13	UNC	0.5000	3	2B	0.367	4.331	1.535	C89322	C98022
1/2-20	UNF	0.5000	3	2B	0.367	4.331	1.535	C89323	C98023
9/16-12	UNC	0.5625	4	2B	0.429	4.331	1.772	C89324	C98024
9/16-18	UNF	0.5625	4	2B	0.429	4.331	1.772	C89325	C98025
5/8-11	UNC	0.6250	4	2B	0.480	4.331	2.087	C89326	C98026
5/8-18	UNF	0.6250	4	2B	0.480	4.331	2.087	C89327	C98027
3/4-10	UNC	0.7500	4	2B	0.590	4.921	2.205	C89328	C98028
3/4-16	UNF	0.7500	4	2B	0.590	4.921	2.205	C89329	C98029
7/8-9	UNC	0.8750	4	2B	0.697	5.512	2.362	C89330	C98030
7/8-14	UNF	0.8750	4	2B	0.697	5.512	2.362	C89331	C98031
1-8	UNC	1.0000	4	2B	0.800	6.299	2.520	C89332	C98032
1-12	UNF	1.0000	4	2B	0.800	6.299	2.520	C89333	C98033

continued on next page

Spiral Flute

Premium High Speed Steel

Material Reference	Steel (HRC)				Stainless Steel			Cast Iron (HRC)		Aluminum and Non-Ferrous	Hi-Temp Alloy		Hardened Steel (HRC)
	Low Carbon		Alloy		Austenitic	Martensitic	PH	Gray	Nodular		Ni, Co, Fe Based Super Alloy	Titanium	
Hardness	13-38	>38	16-38	>38	300 Series	400 series		18-22	22-32				>45
Black Oxide	◆		◆		◆	◆		◆	◆				
Hardlube	☆	◆	☆	◆	☆	☆	☆	☆	☆				

☆ = Best Performance ◆ = Acceptable



Spiral Flute

Premium High Speed Steel

tap size and pitch d ₁	thread form	decimal equiv.	no. of flutes	class of fit	shank diameter		overall length L		thread length l		order number	
					in	mm	in	mm	in	mm	Black Oxide PER-893SF	Hardlube PER-980SF
M3x0.5	M	0.1181	3	6H	0.141	3.58	2.205	56	0.748	19	C89334	C98034
M3.5x0.6	M	0.1378	3	6H	0.141	3.58	2.205	56	0.787	20	C89335	C98035
M4x0.7	M	0.1575	3	6H	0.168	4.27	2.480	63	0.827	21	C89336	C98036
M5x0.8	M	0.1969	3	6H	0.194	4.93	2.756	70	1.024	26	C89337	C98037
M6x1	M	0.2362	3	6H	0.255	6.48	3.150	80	1.260	32	C89338	C98038
M7x1	M	0.2756	3	6H	0.318	8.08	3.150	80	1.181	30	C89339	C98039
M8x1	M	0.3150	3	6H	0.318	8.08	3.543	90	1.378	35	C89340	C98040
M8x1.25	M	0.3150	3	6H	0.318	8.08	3.543	90	1.378	35	C89341	C98041
M10x1.25	M	0.3937	3	6H	0.381	9.68	3.937	100	1.575	40	C89342	C98042
M10x1.5	M	0.3937	3	6H	0.381	9.68	3.937	100	1.575	40	C89343	C98043
M12x1.25	M	0.4724	3	6H	0.367	9.32	4.331	110	1.575	40	C89344	C98044
M12x1.75	M	0.4724	3	6H	0.367	9.32	4.331	110	1.575	40	C89345	C98045
M14x1.5	M	0.5512	3	6H	0.429	10.9	4.331	110	1.772	45	C89346	C98046
M14x2	M	0.5512	3	6H	0.429	10.9	4.331	110	1.772	45	C89347	C98047
M16x1.5	M	0.6299	4	6H	0.480	12.19	4.331	110	2.087	53	C89348	C98048
M16x2	M	0.6299	4	6H	0.480	12.19	4.331	110	2.087	53	C89349	C98049
M18x1.5	M	0.7087	4	6H	0.542	13.77	4.921	125	2.165	55	C89350	C98050
M18x2.5	M	0.7087	4	6H	0.542	13.77	4.921	125	2.165	55	C89351	C98051
M20x2.5	M	0.7874	4	6H	0.650	16.51	5.512	140	2.480	63	C89352	C98052
M22x2.5	M	0.8661	4	6H	0.697	17.70	5.512	140	2.362	60	C89353	C98053
M24x3.0	M	0.9449	4	6H	0.760	19.30	6.299	160	2.598	66	C89354	C98054

Material Reference	Steel (HRC)				Stainless Steel			Cast Iron (HRC)		Aluminum and Non-Ferrous	Hi-Temp Alloy		Hardened Steel (HRC)
	Low Carbon		Alloy		Austenitic	Martensitic	PH	Gray	Nodular		Ni, Co, Fe Based Super Alloy	Titanium	
Hardness	13-38	>38	16-38	> 38	300 Series	400 series		18-22	22-32			>45	
Black Oxide	◆		◆		◆	◆		◆	◆				
Hardlube	☆	◆	☆	◆	☆	☆	☆	☆	☆				

☆ = Best Performance ◆ = Acceptable



Styles: **1091, 1092**

Note

Modify tapping speeds listed in the Technical section as follows: double the speeds versus thread cutting taps.



Surface Treatment

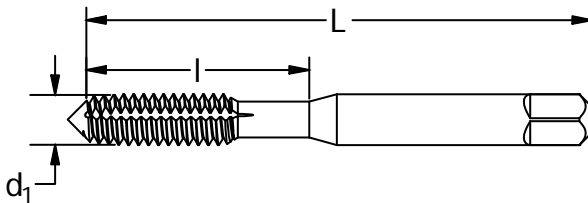

tap size and pitch d ₁	thread form	decimal equiv.	H-limit	overall length		thread length		order number	
				L (in)	I (in)	1091 Plug	1092 Bottoming		
*0-80	UNF	.0600	H2	1.625	.313	-	-	C59159	C59159
*2-56	UNC	.0860	H2	1.750	.438	-	-	C59177	C59177
4-40	UNC	.1120	H3	1.875	.563	C59193	C59193	C59194	C59194
5-40	UNC	.1250	H3	1.938	.625	C59209	C59209	C59210	C59210
6-32	UNC	.1380	H3	2.000	.688	C59221	C59221	C59222	C59222
6-32	UNC	.1380	H5	2.000	.688	C59223	C59223	C59224	C59224
8-32	UNC	.1640	H3	2.125	.750	C59235	C59235	C59236	C59236
8-32	UNC	.1640	H5	2.125	.750	C59237	C59237	C59238	C59238
10-24	UNC	.1900	H4	2.375	.875	C59249	C59249	C59250	C59250
10-24	UNC	.1900	H6	2.375	.875	C59251	C59251	C59252	C59252
10-32	UNF	.1900	H4	2.375	.875	C59256	C59256	C59257	C59257
10-32	UNF	.1900	H6	2.375	.875	C59258	C59258	C59259	C59259
1/4-20	UNC	.2500	H4	2.500	1.000	C59282	C59282	C59283	C59283
1/4-20	UNC	.2500	H6	2.500	1.000	C59284	C59284	C59285	C59285
1/4-28	UNF	.2500	H4	2.500	1.000	C59289	C59289	C59290	C59290
5/16-18	UNC	.3125	H5	2.719	1.125	C59299	C59299	C59300	C59300
5/16-18	UNC	.3125	H7	2.719	1.125	C59301	C59301	C59302	C59302
3/8-16	UNC	.3750	H7	2.938	1.250	C59317	C59317	C59318	C59318
3/8-24	UNF	.3750	H5	2.938	1.250	C59321	C59321	-	-
3/8-24	UNF	.3750	H7	2.938	1.250	C59323	C59323	-	-
1/2-13	UNC	.5000	H8	3.375	1.656	C59361	C59361	C59362	C59362

*#0-#2: 302 blank style

Thread Forming

High Speed Steel

Styles: **1091, 1092**

General Purpose Metric

tap size and pitch d ₁	decimal equiv.	D-limit	overall length L		thread length I		order number	
			in	mm	in	mm	1091 Plug	1092 Bottoming
M3 x 0.5	.1181	D5	1.938	49.21	.625	15.88	C59420	C59421
M4 x 0.7	.1575	D6	2.125	53.98	.750	19.05	C59424	C59425
M5 x 0.8	.1968	D7	2.375	60.33	.875	22.23	C59428	C59429
M6 x 1	.2362	D8	2.500	63.50	1.000	25.40	C59432	C59433
M8 x 1.25	.3150	D9	2.719	69.06	1.125	28.58	C59436	C59437
M10 x 1.5	.3937	D10	2.938	74.61	1.250	31.75	C59440	C59441

Material Reference	Steel (HRC)				Stainless Steel			Cast Iron (HRC)		Aluminum and Non-Ferrous	Hi-Temp Alloy		Hardened Steel (HRC)
	Low Carbon		Alloy		Austenitic	Martensitic	PH	Gray	Nodular		Ni, Co, Fe Based Super Alloy	Titanium	
	Hardness	13-38	>38	16-38	> 38	300 Series	400 series		18-22	22-32			>45
Bright	☆		☆		☆					☆			

☆ = Best Performance ◆ = Acceptable

Threading

NPT/NPTF
Medium Hook - Taper



Styles: **965B, 965TN, 975, 975TN**

Note
Tapping Speeds and Feeds
see Technical section.

HSS
311
3/4" / 12"
Pipe 3-1/2
NPT
NPTF Dryseal
Surface Treatment
Bright
TiN

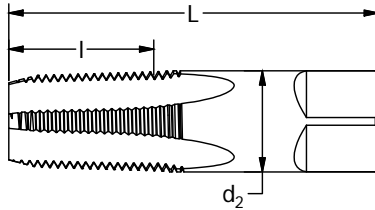

Pipe Tap
High Speed Steel

tap size and pitch	decimal equiv.	# of flutes	shank diameter d_2 (in)	overall length l_1 (in)	thread length l_2 (in)	order number			
						Bright		TiN	
						965B NPT	975 NPTF	965TN NPT	975TN NPTF
1/16-27	.0625	4	.3125	2.125	.688	C64036	C64058	C56700	C55680
1/8-27*	.1250	4	.3125	2.125	.750	C64037	C64059	C56701	-
1/8-27	.1250	4	.4375	2.125	.750	C64038	C64060	C56702	C55682
1/4-18	.2500	4	.5625	2.438	1.063	C64039	C64061	C56703	C55683
3/8-18	.3750	4	.7000	2.563	1.063	C64040	C64062	C56704	C55684
1/2-14	.5000	4	.6875	3.125	1.375	C64041	C64063	C56705	C55685
3/4-14	.7500	5	.9063	3.250	1.375	C64042	C64064	C56706	C55686
1-11-1/2	1.0000	5	1.1250	3.750	1.750	C64043	C64065	-	C55687
1-1/4-11-1/2	1.2500	5	1.3125	4.000	1.750	C64044	-	-	-
1-1/2-11-1/2	1.5000	7	1.5000	4.250	1.750	C64045	-	-	-
2-11-1/2	2.0000	7	1.8750	4.500	1.750	C64046	-	-	-

* small shank

Material Reference	Steel (HRC)				Stainless Steel			Cast Iron (HRC)		Aluminum and Non-Ferrous	Hi-Temp Alloy		Hardened Steel (HRC)
	Low Carbon		Alloy		Austenitic	Martensitic	PH	Gray	Nodular		Ni, Co, Fe Based Super Alloy	Titanium	
	Hardness	13-38	>38	16-38	> 38	300 Series	400 series		18-22	22-32			>45
Bright	☆		☆					◆	◆				
TiN													

☆ = Best Performance ◆ = Acceptable



Styles: 964B, 966B
NPT/NPTF
 Interrupted Thread - Taper

Note
 Tapping Speeds and Feeds
 see Technical section.

HSS	311	3/4" / 12"	Pipe 3-1/2	NPT	NPTF Dryseal	Surface Treatment	Bright
-----	-----	------------	------------	-----	--------------	-------------------	--------

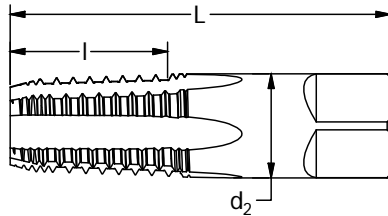

tap size and pitch	decimal equiv.	no. of flutes	shank diameter d ₂ (in)	overall length L (in)	thread length l (in)	order number	
						964B NPT	966B NPTF
1/8-27*	.1250	5	.3125	2.125	.750	–	C64107
1/8-27	.1250	5	.4375	2.125	.750	C64098	C64108
1/4-18	.2500	5	.5625	2.438	1.063	C64099	C64109
3/8-18	.3750	5	.7000	2.563	1.063	C64100	C64110
1/2-14	.5000	5	.6875	3.125	1.375	C64101	C64111
3/4-14	.7500	5	.9063	3.250	1.375	C64102	C64112
1 – 11-1/2	1.0000	5	1.1250	3.750	1.750	C64103	–

*small shank

Pipe Tap
High Speed Steel

Material Reference	Steel (HRc)		Stainless Steel			Cast Iron (HRc)		Aluminum and Non-Ferrous	Hi-Temp Alloy		Hardened Steel (HRc)
	Low Carbon	Alloy	Austenitic	Martensitic	PH	Gray	Nodular		Ni, Co, Fe Based Super Alloy	Titanium	
Hardness	13-38	>38	16-38	> 38	300 Series	400 series					>45
Bright	☆		☆				☆	☆			

☆ = Best Performance ◆ = Acceptable

Threading

NPS/NPSF
Straight



Styles: **963B**, **967B**

Note
Tapping Speeds and Feeds
see Technical section.



Surface Treatment

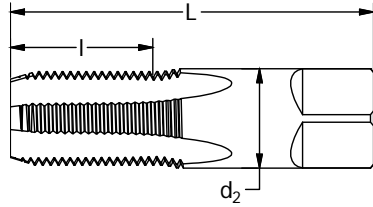

Dies

High Speed Steel

tap size and pitch	decimal equiv.	no. of flutes	shank diameter d_2 (in)	overall length L (in)	thread length I (in)	order number	
						963B NPS	967B NPSF
1/8-27*	.1250	4	.3125	2.125	.750	—	C64129
1/8-27	.1250	4	.4375	2.125	.750	C64116	C64130
1/4-18	.2500	4	.5625	2.438	1.063	C64117	C64131
3/8-18	.3750	4	.7000	2.563	1.063	C64118	C64132
1/2-14	.5000	4	.6875	3.125	1.375	C64119	C64133

* small shank

Material Reference	Steel (HRC)				Stainless Steel			Cast Iron (HRC)		Aluminum and Non-Ferrous	Hi-Temp Alloy		Hardened Steel (HRC)
	Low Carbon		Alloy		Austenitic	Martensitic	PH	Gray	Nodular		Ni, Co, Fe Based Super Alloy	Titanium	
Hardness	13-38	>38	16-38	> 38	300 Series	400 series		18-22	22-32				>45
Bright	☆		☆					◆	◆				

☆ = Best Performance ◆ = Acceptable





Style: CMTM2

Mini - Inch
2x Diameter

Note

Formula: $2 \times d_1$ ($l_2 \leq 2 \times$ Thread Diameter)

* Bore diameter applies to the smallest thread diameter.

For Internal & External Threads

Carbide

Surface Treatment

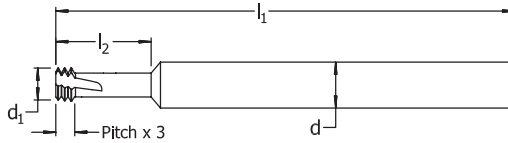

Feature:

Excel in internal deep threads in hard to cut materials.

American UN	thread	shank diameter	cutting diameter	overall length	cut depth	pitch x 3	no. of	no. of	*bore dia.	order number	
UNC	UNF	TPI	pitch	d	d ₁	l ₁	l ₂	thread length	flutes	teeth	CMTM2
1-72	72	0.014	1/4	.057	2.5	.154	0.042	3	3	.060	C95102
1-64	64	0.016	1/4	.057	2.5	.165	0.047	3	3	.060	C95103
2-56	56	0.018	1/4	.065	2.5	.197	0.054	3	3	.069	C95104
3-48	48	0.021	1/4	.075	2.5	.236	0.063	3	3	.080	C95105
4, 5-40	40	0.025	1/4	.085	2.5	.236	0.075	3	3	.090	C95106
	8-36	36	0.028	1/4	2.5	.343	0.083	3	3	.125	C95107
6, 8-32	32	0.031	1/4	.100	2.5	.292	0.094	3	3	.110	C95108
8-32	32	0.031	1/4	.120	2.5	.394	0.094	3	3	.130	C95109
	1/4"x28	28	0.036	1/4	2.5	.520	0.107	3	3	.190	C95110
10-24	24	0.042	1/4	.130	2.5	.400	0.125	3	3	.140	C95111
	5/16"x24	24	0.042	1/4	2.5	.650	0.125	3	3	.255	C95112
1/4"x20	20	0.05	1/4	.185	2.5	.530	0.150	3	3	.200	C95113
	7/16"x20	20	0.05	3/8	3	.900	0.150	4	3	.355	C95114
3/8"x16	16	0.063	3/8	.290	3	.750	0.188	4	3	.307	C95115
7/16"x14	14	0.071	3/8	.340	3	.900	0.214	4	3	.355	C95116
1/2-13	13	0.077	3/8	.350	3	1.10	0.231	4	3	.415	C95117

Mini Thread Mills

Carbide

Style: CMTMM2

Mini - Metric
2x Diameter

Note

Formula: $2 \times d_1$ ($l_2 \leq 2 \times$ Thread Diameter)

* Bore diameter applies to the smallest thread diameter.

For Internal & External Threads

Carbide

Surface Treatment



ISO metric	pitch	shank diameter	cutting diameter	overall length	cut depth	pitch x 3	no. of	no. of	*bore dia.	order number		
M course	M fine	mm	inch	d	d ₁	l ₁	l ₂	thread length	flutes	teeth	CMTMM2	
M1.6x0.35		0.35	0.014	3.175	1.193	63.5	3.56	1.07	3	3	.050	C95127
M2x0.4		0.40	0.016	6.350	1.524	63.5	4.19	1.22	3	3	.065	C95128
M2.2x0.45		0.45	0.018	6.350	1.651	63.5	4.57	1.37	3	3	.070	C95129
M2.5x0.45		0.45	0.018	6.350	1.905	63.5	5.08	1.37	3	3	.080	C95130
M3x0.5	M3.5-M16x0.5	0.50	0.020	6.350	2.286	63.5	6.22	1.52	3	3	.095	C95131
M3.5x0.6		0.60	0.024	6.350	2.667	63.5	7.24	1.83	3	3	.111	C95132
M4x0.7		0.70	0.028	6.350	3.048	63.5	8.26	2.13	3	3	.126	C95133
M5x0.8		0.80	0.031	6.350	3.937	63.5	10.16	2.36	3	3	.161	C95134
M6x1.0	M8-M40x1.0	1.00	0.039	6.350	4.699	63.5	12.70	2.97	3	3	.193	C95135
M8x1.25		1.25	0.049	6.350	6.223	63.5	16.51	3.73	3	3	.257	C95136
M10x1.5	M12-M48x1.50	1.50	0.059	9.525	8.382	76.2	20.32	4.49	3	3	.343	C95137
M12x1.75		1.75	0.069	9.525	9.144	76.2	25.40	5.26	4	3	.395	C95138

Material Reference	Steel (HRC)				Stainless Steel			Cast Iron (HRC)		Aluminum and Non-Ferrous	Hi-Temp Alloy		Hardened Steel (HRC)
	Low Carbon		Alloy		Austenitic	Martensitic	PH	Gray	Nodular		Ni, Co, Fe Based Super Alloy	Titanium	
	Hardness	13-38	>38	16-38	>38	300 Series	400 series		18-22	22-32			>45
AlCrN	◆	☆	◆	☆	☆	☆	☆	◆	◆	◆	☆	☆	☆

☆ = Best Performance ◆ = Acceptable

Mini - Inch 3x Diameter

Style: **CMTM3**

Carbide

Surface Treatment



Note

Formula: $3 \times d_1$ ($l_2 \leq 3 \times$ Thread Diameter)

* Bore diameter applies to the smallest thread diameter.

For Internal & External Threads

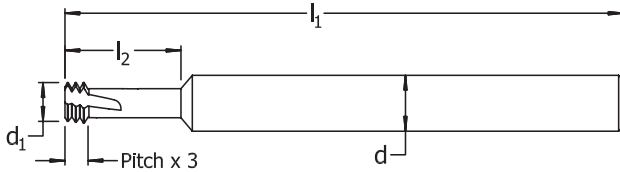

Mini Thread Mills

Carbide

American UN		thread		shank diameter	cutting diameter	overall length	cut depth	pitch x 3	no. of	no. of	*bore dia.	order number
UNC	UNF	TPI	pitch	d	d ₁	l ₁	l ₂	length	flutes	teeth		CMTM3
	1-72	72	0.014	1/4	.057	2.5	.240	0.042	3	3	.060	C95118
2-56	3-56	56	0.018	1/4	.065	2.5	.260	0.054	3	3	.069	C95119
4, 5-40	6-40	40	0.025	1/4	.085	2.5	.310	0.075	3	3	.090	C95120
5-40	6-40	40	0.025	1/4	.100	2.5	.400	0.075	3	3	.110	C95121
8-32	10-32	32	0.031	1/4	.120	2.5	.500	0.094	3	3	.130	C95122
	1/4"x28	28	0.036	1/4	.180	2.5	.750	0.107	3	3	.190	C95123
1/4"x20	7/16"x20	20	0.05	1/4	.185	2.5	.750	0.150	3	3	.200	C95124
	5/16"x24	24	0.042	1/4	.240	2.5	.940	0.125	3	3	.255	C95125
5/16"x18		18	0.056	1/4	.240	2.5	.900	0.167	3	3	.255	C95126

Mini - Metric 3x Diameter

Style: **CMTMM3**

Carbide

Surface Treatment



Note

Formula: $3 \times d_1$ ($l_2 \leq 3 \times$ Thread Diameter)

* Bore diameter applies to the smallest thread diameter.

For Internal & External Threads

ISO metric		pitch		shank diameter	cutting diameter	overall length	cut depth	pitch x 3	no. of	no. of	*bore dia.	order number
M course	M fine	mm	inch	d	d ₁	l ₁	l ₂	length	flutes	teeth		CMTMM3
M1.6x0.35		0.35	0.014	3.175	1.938	63.5	5.00	1.07	3	3	.050	C95139
M2x0.4		0.40	0.016	6.350	1.524	63.5	6.22	1.22	3	3	.065	C95140
M2.5x0.45		0.45	0.018	6.350	1.905	63.5	6.99	1.37	3	3	.080	C95141
M3x0.5	M3.5-M16x0.5	0.50	0.020	6.350	2.286	63.5	9.149	1.52	3	3	.095	C95142
M4x0.7		0.70	0.028	6.350	3.048	63.5	12.45	2.13	3	3	.126	C95143
M5x0.8		0.80	0.031	6.350	3.937	63.5	15.49	2.36	3	3	.161	C95144
M6x1.0	M8-M40x1.0	1.00	0.039	6.350	4.699	63.5	18.42	2.97	3	3	.193	C95145
M8x1.25		1.25	0.049	6.350	6.223	63.5	21.64	3.73	3	3	.257	C95146

Material Reference	Steel (HRc)				Stainless Steel			Cast Iron (HRc)		Aluminum and Non-Ferrous	Hi-Temp Alloy		Hardened Steel (HRc)
	Low Carbon		Alloy		Austenitic	Martensitic	PH	Gray	Nodular		Ni, Co, Fe Based Super Alloy	Titanium	
	Hardness	13-38	>38	16-38	>38	300 Series	400 series		18-22	22-32			>45
AICrN	◆	☆	◆	☆	☆	☆	☆	◆	◆	◆	☆	☆	☆

☆ = Best Performance ◆ = Acceptable

Note
 For Internal & External Threads

 UNC
 UNF

Carbide

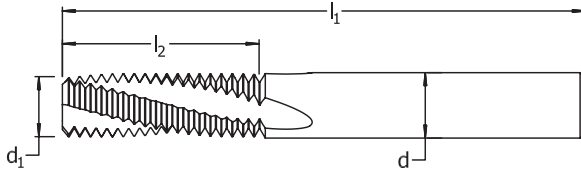
 Surface
 Treatment

Feature:

Capable of producing right or left hand threads.

thread size	shank diameter d	cutting diameter d₁	overall length l₁	length of cut l₂	number of flutes	order number	
						CTM non-coolant	CTMC coolant-thru
6-32	1/8	.095	2	.218	3	C95000	—
8-32	1/8	.115	2	.250	3	C95001	—
8-36	1/8	.115	2	.250	3	C95002	—
10-24	3/16	.120	2	.312	3	C95003	—
10-32	3/16	.120	2	.312	3	C95004	—
1/4-20	3/16	.180	2-1/2	.500	3	C95005	C95026
1/4-28	3/16	.180	2-1/2	.500	3	C95006	C95027
5/16-18	1/4	.240	2-1/2	.625	3	C95007	C95028
5/16-24	1/4	.240	2-1/2	.625	3	C95008	C95029
3/8-16	5/16	.290	3	.750	4	C95009	C95030
3/8-24	5/16	.290	3	.750	4	C95010	C95031
7/16-14	3/8	.340	3	.875	4	C95011	C95032
7/16-20	3/8	.340	3	.875	4	C95012	C95033
1/2-13	3/8	.350	3-1/2	.875	4	C95013	C95034
1/2-20	3/8	.350	3-1/2	.875	4	C95014	—
9/16-12	1/2	.370	3-1/2	.875	4	C95015	C95035
9/16-18	1/2	.370	3-1/2	.875	4	C95016	C95036
5/8-11	1/2	.470	3-1/2	1.250	5	C95017	C95037
5/8-18	1/2	.470	3-1/2	1.250	5	C95018	C95038
3/4-10	1/2	.495	3-1/2	1.250	5	C95019	C95039
3/4-12	1/2	.495	3-1/2	1.250	5	C95020	C95040
3/4-16	1/2	.495	3-1/2	1.250	5	C95021	C95041
7/8-9	1/2	.495	3-1/2	1.250	5	C95022	C95042
7/8-14	1/2	.495	3-1/2	1.250	5	C95023	C95043
1-8	3/4	.620	4	1.375	5	C95024	C95044
1-12	3/4	.620	4	1.375	5	C95025	C95045

Thread Mills

Carbide

Material Reference	Steel (HRC)				Stainless Steel			Cast Iron (HRC)		Aluminum and Non-Ferrous	Hi-Temp Alloy		Hardened Steel (HRC)
	Low Carbon		Alloy		Austenitic	Martensitic	PH	Gray	Nodular		Ni, Co, Fe Based Super Alloy	Titanium	
	Hardness	13-38	>38	16-38	> 38	300 Series	400 series		18-22	22-32			>45
TiAIN	☆	◆	☆	◆	☆	☆	☆	◆	◆		◆	◆	◆

☆ = Best Performance ◆ = Acceptable

General Purpose Metric - Helical Thread Mills

Styles: **CTMM** Solid and **CTMMC** Coolant-Thru

Note
For Internal & External Threads

DIN Carbide Surface Treatment TiAlN

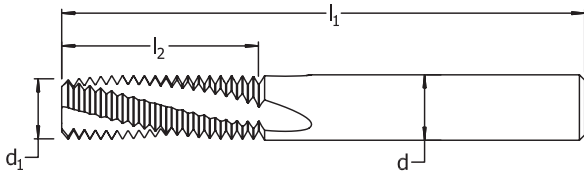

Feature:
Excellent option in difficult materials.

Thread Mills

Carbide

thread size	shank diameter d	cutting diameter d ₁	overall length l ₁	length of cut l ₂	number of flutes	order number	
						CTMM non-coolant	CTMMC coolant-thru
M4 X 0.70	1/8	.120	2	.250	2	C95072	—
M4.5 X 0.75	1/8	.120	2	.250	3	C95073	—
M5 X 0.80	3/16	.120	2	.312	3	C95074	C95088
M6 X 1.00	3/16	.170	2-1/2	.500	3	C95075	C95089
M8 X 0.75	1/4	.235	2-1/2	.625	3	C95076	C95090
M8 X 1.00	1/4	.235	2-1/2	.625	3	C95077	C95091
M8 X 1.25	1/4	.235	2-1/2	.625	3	C95078	C95092
M10 X 1.25	5/16	.300	3	.750	4	C95079	C95093
M10 X 1.50	5/16	.300	3	.750	4	C95080	C95094
M12 X 1.00	3/8	.360	3-1/2	.875	4	C95081	C95095
M12 X 1.25	3/8	.360	3-1/2	.875	4	C95082	C95096
M12 X 1.75	3/8	.360	3-1/2	.875	4	C95083	C95097
M14 X 1.50	3/8	.360	3-1/2	.875	4	C95084	C95098
M16 X 2.00	1/2	.470	3-1/2	1.250	5	C95085	C95099
M18 X 2.50	1/2	.470	3-1/2	1.250	5	C95086	C95100
M20 X 3.00	1/2	.470	3-1/2	1.250	5	C95087	C95101

National Pipe Tapered Inch - Helical Thread Mills

Styles: **CTMNP** Solid and **CTMNPC** Coolant-Thru

Note
For Internal & External Threads

NPT NPTF Carbide Surface Treatment TiAlN

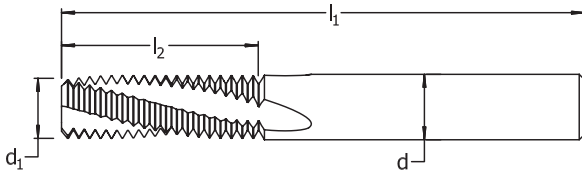

Feature:
Designed to cut internal and external threads.

thread size	shank diameter d	cutting diameter d ₁	overall length l ₁	length of cut l ₂	number of flutes	order number	
						CTMNP non-coolant	CTMNPC coolant-thru
1/16-27	1/4	.245	2-1/2	.437	3	C95046	C95051
1/8-27	5/16	.310	2-1/2	.437	4	C95047	C95052
1/4, 3/8-18	3/8	.305	3	.625	4	C95048	C95053
1/2, 3/4-14	1/2	.495	3-1/2	.875	4	C95049	C95054
1-11.5	3/4	.620	4	1.125	5	C95050	C95055

Material Reference	Steel (HRc)				Stainless Steel			Cast Iron (HRc)		Aluminum and Non-Ferrous	Hi-Temp Alloy		Hardened Steel (HRc)
	Low Carbon		Alloy		Austenitic	Martensitic	PH	Gray	Nodular		Ni, Co, Fe Based Super Alloy	Titanium	
	Hardness	13-38	>38	16-38	>38	300 Series	400 series		18-22	22-32			>45
TiAlN	☆	◆	☆	◆	☆	☆	☆	◆	◆		◆	◆	◆

☆ = Best Performance ◆ = Acceptable

Styles: CTMBPP Solid and CTMBPPC Coolant-Thru

British Pipe Tapered Inch - Helical Thread Mills

Note
For Internal & External Threads

BSPP

Carbide

Surface
Treatment

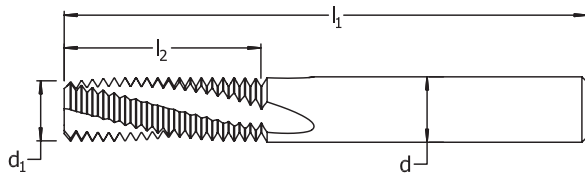

Feature:
55 degree thread profile.

thread size	shank diameter d	cutting diameter d ₁	overall length l ₁	length of cut l ₂	number of flutes	order number	
						CTMBPP non-coolant	CTMBPPC coolant-thru
1/16, 1/8-28	1/4	.240	2-1/2	.572	3	C95056	C95060
1/4-19	5/16	.312	3	.737	4	C95057	C95061
1/2-14	1/2	.470	3-1/2	1.143	4	C95058	C95062
1-11	5/8	.620	4	1.546	5	C95059	C95063

Thread Mills

Styles: CTMBPT Solid and CTMBPTC Coolant-Thru

British Pipe Parallel Inch - Helical Thread Mills

Note
For Internal & External Threads

BSPT

Carbide

Surface
Treatment

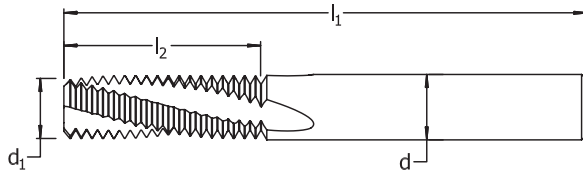

Feature:
55 degree thread profile.

thread size	shank diameter d	cutting diameter d ₁	overall length l ₁	length of cut l ₂	number of flutes	order number	
						CTMBPT non-coolant	CTMBPTC coolant-thru
1/16, 1/8-28	1/4	.240	2-1/2	.401	3	C95064	C95068
1/4-19	5/16	.312	3	.578	4	C95065	C95069
1/2-14	1/2	.470	3-1/2	.785	4	C95066	C95070
1-11	5/8	.620	4	1.546	5	C95067	C95071

Carbide

Material Reference	Steel (HRC)				Stainless Steel			Cast Iron (HRC)		Aluminum and Non-Ferrous	Hi-Temp Alloy		Hardened Steel (HRC)
	Low Carbon		Alloy		Austenitic	Martensitic	PH	Gray	Nodular		Ni, Co, Fe Based Super Alloy	Titanium	
	Hardness	13-38	>38	16-38	> 38	300 Series	400 series		18-22	22-32			>45
TiAlN	☆	◆	☆	◆	☆	☆	☆	◆	◆		◆	◆	◆

☆ = Best Performance ◆ = Acceptable

HSS

Carbon
Steel

Surface
Treatment

Bright



Feature:

Suitable for the repair of existing threads.

Dies

Carbon Steel / High Speed Steel

die diameter TPI and series			decimal equiv.	length across flats in	thickness in	order number	
						0650 carbon steel	492 high-speed steel
1/4	20	UNC	.2500	19/32	1/4	C65601	C77600
1/4	28	UNF	.2500	19/32	1/4	C65602	C77602
5/16	18	UNC	.3125	11/16	5/16	C65603	C77604
5/16	24	UNF	.3125	11/16	5/16	C65605	C77606
3/8	16	UNC	.3750	25/32	3/8	C65606	C77608
3/8	24	UNF	.3750	25/32	3/8	C65607	C77610
7/16	14	UNC	.4375	7/8	7/16	C65608	C77612
7/16	20	UNF	.4375	7/8	7/16	C65609	C77614
1/2	13	UNC	.5000	1 1/16	1/2	C65610	C77616
1/2	20	UNF	.5000	1 1/16	1/2	C65611	C77618
9/16	12	UNC	.5625	1 1/16	1/2	C65612	C77620
9/16	18	UNF	.5625	1 1/16	1/2	C65613	C77622
5/8	11	UNC	.6250	1 1/4	5/8	C65614	C77624
5/8	18	UNF	.6250	1 1/4	5/8	C65615	C77626
11/16	11	UNS	.6875	1 7/16	3/4	C65616	—
11/16	16	UNS	.6875	1 7/16	3/4	C65617	—
3/4	10	UNC	.7500	1 7/16	3/4	C65618	C77628
3/4	16	UNF	.7500	1 7/16	3/4	C65619	C77630
7/8	9	UNC	.8750	1 5/8	7/8	C65620	C77632
7/8	14	UNF	.8750	1 5/8	7/8	C65621	C77634
1	8	UNC	1.0000	1 13/16	1	C65622	C77636
1	12	UNF	1.0000	1 13/16	1	C65623	C77638
1	14	UNS	1.0000	1 13/16	1	C65624	C77640
1-1/8	7	UNC	1.1250	2	1	C65625	C77642
1-1/8	12	UNF	1.1250	2	1	C65627	C77644
1-1/4	7	UNC	1.2500	2 3/16	1	C65628	C77646
1-1/4	12	UNF	1.2500	2 3/16	1	C65629	—
1-3/8	6	UNC	1.4100	2 3/8	1	C65630	C77648
1-3/8	12	UNF	1.4100	2 3/8	1	C65631	—
1-1/2	6	UNC	1.5000	2 9/16	1	C65632	C77650
1-1/2	12	UNF	1.5000	2 9/16	1	C65633	—

Hexagon Rethreading Taper Pipe

Styles: 0660

HSS
Carbon Steel
Surface Treatment
Bright
Feature:

Suitable for the repair of existing threads.

die diameter		decimal equiv.	length across flats		thickness		order number
TPI	series		in	mm	in	mm	0660 carbon steel
1/8	27	NPT	.1250	1-1/16	3/8		C65571
1/4	18	NPT	.2500	1-1/4	5/8		C65572
3/8	18	NPT	.3750	1-7/16	5/8		C65573
1/2	14	NPT	.5000	1-5/8	3/4		C65574
3/4	14	NPT	.7500	2	13/16		C65575
1	11-1/2	NPT	1.0000	2-3/8	1		C65576

Styles: 0650M

Hexagon Rethreading Metric

die diameter		decimal equiv.	length across flats		thickness		order number
TPI	series		in	mm	in	mm	0650M carbon steel
M3 x 0.5		.1181	19/32	15.08	1/4	6.35	C29192
M4 x 0.7		.1575	19/32	15.08	1/4	6.35	C29193
M5 x 0.8		.1969	19/32	15.08	1/4	6.35	C65580
M6 x 1		.2362	19/32	15.08	1/4	6.35	C65581
M7 x 1		.2756	11/16	17.46	5/16	7.92	C29194
M8 x 1.25		.3150	11/16	17.46	5/16	7.94	C65582
M10 x 1.25		.3937	7/8	22.23	7/16	11.11	C29195
M10 x 1.5		.3937	7/8	22.23	7/16	11.11	C65583
M12 x 1.75		.4724	1-1/16	26.98	1/2	12.70	C65584
M14 x 2		.5513	1-1/16	26.98	1/2	12.70	C29196
M14 x 2		.5512	1-1/16	26.98	1/2	12.70	C65585
M16 x 2		.6299	1-1/4	31.75	5/8	15.88	C65586
M18 x 1.5		.7087	1-7/16	36.52	7/8	22.23	C29197
M18 x 2.5		.7087	1-7/16	36.52	7/8	22.23	C29198
M20 x 2.5		.7874	1-5/8	41.28	7/8	22.23	C65587
M24 x 3		.9449	1-13/16	46.04	1	25.40	C29199

Dies
Carbon Steel
SET
Style: 0650, 0650M

Hexagon Die Carbon Steel

set number	number of sizes	die sizes		order number	set number	number of sizes	die sizes		order number
				0650					0650M
42NC	8	1/4-20 NC	1/2-13 NC	C67275	49Metric	7	M6 x 1		C67283
		5/16-18 NC	9/16-12 NC				M8 x 1.25		
		3/8-16 NC	5/8-11 NC				M10 x 1.5		
		7/16-14 NC	3/4-10 NC				M12 x 1.75		
42NF	8	1/4-28 NF	1/2-20 NF	C67276			M14 x 2		
		5/16-24 NF	9/16-18 NF				M16 x 2		
		3/8-24 NF	5/8-18 NF				M20 x 2.5		
		7/16-20 NF	3/4-16 NF						
44NC	10	1/4-20 NC	9/16-12 NC	C67278					
		5/16-18 NC	5/8-11 NC						
		3/8-16 NC	3/4-10 NC						
		7/16-14 NC	7/8-9 NC						
		1/2-13 NC	1-8 NC						
45NCNF	20	1/4-20 NC	1/4-28 NF	C67282					
		5/16-18 NC	5/16-24 NF						
		3/8-16 NC	3/8-24 NF						
		7/16-14 NC	7/16-20 NF						
		1/2-13 NC	1/2-20 NF						
		9/16-12 NC	9/16-18 NF						
		5/8-11 NC	5/8-18 NF						
		3/4-10 NC	3/4-16 NF						
		7/8-9 NC	7/8-14 NF						
		1-8 NC	1-14 NF						



Set C67275



Set C67278



HSS

Carbon Steel

Surface Treatment

Bright

Feature:

Designed to cut threads in bar stock.

Dies

Carbon Steel / High Speed Steel

die diameter			decimal equiv.	outside diameter		thickness in	order number	
TPI and series				in	in		0610 carbon steel	0710 high-speed steel
0	80	UNF	.0600	13/16	1/4	C65022	—	
1	64	UNC	.0730	13/16	1/4	C65026	—	
1	72	UNF	.0730	13/16	1/4	C65027	—	
2	56	UNC	.0860	13/16	1/4	C65036	—	
2	64	UNF	.0860	13/16	1/4	C65037	—	
3	48	UNC	.0990	13/16	1/4	C65045	—	
3	56	UNF	.0990	13/16	1/4	C65046	—	
4	40	UNC	.1120	13/16	1/4	C65048	—	
4	48	UNF	.1120	13/16	1/4	C65049	—	
5	40	UNC	.1250	13/16	1/4	C65057	C65729	
5	44	UNF	.1250	13/16	1/4	C65058	C65730	
6	32	UNC	.1380	13/16	1/4	C65061	C65733	
6	32	UNC	.1380	1	3/8	C65114	C65785	
6	40	UNF	.1380	13/16	1/4	C65062	C65734	
8	32	UNC	.1640	13/16	1/4	C65069	C65739	
8	32	UNC	.1640	1	3/8	C65119	C65789	
8	36	UNF	.1640	13/16	1/4	C65070	C65740	
10	24	UNC	.1900	13/16	1/4	C65075	C65743	
10	24	UNC	.1900	1	3/8	C65124	C65792	
10	32	UNF	.1900	13/16	1/4	C65076	C65744	
10	32	UNF	.1900	1	3/8	C65125	C65793	
12	24	UNC	.2160	13/16	1/4	C65083	C65751	
12	24	UNC	.2160	1	3/8	C65132	C65798	
12	28	UNF	.2160	13/16	1/4	C65084	C65752	
1/4	20	UNC	.2500	13/16	1/4	C65093	C65760	
1/4	20	UNC	.2500	1	3/8	C65140	C65804	
1/4	20	UNC	.2500	1-1/2	1/2	C65192	C65839	
1/4	20	UNC	.2500	2	5/8	C65264	—	
1/4	28	UNF	.2500	13/16	1/4	—	C65761	
1/4	28	UNF	.2500	1	3/8	C65142	C65805	
1/4	28	UNF	.2500	1-1/2	1/2	C65193	C65840	
1/4	28	UNF	.2500	2	5/8	C65265	—	
5/16	18	UNC	.3125	13/16	1/4	—	C65766	
5/16	18	UNC	.3125	1	3/8	C65147	C65808	
5/16	18	UNC	.3125	1-1/2	1/2	C65197	C65844	
5/16	18	UNC	.3125	2	5/8	C65269	—	
5/16	24	UNF	.3125	13/16	1/4	—	C65767	
5/16	24	UNF	.3125	1	3/8	C65148	C65809	
5/16	24	UNF	.3125	1-1/2	1/2	C65198	C65845	
5/16	24	UNF	.3125	2	5/8	C65270	—	
3/8	16	UNC	.3750	1	3/8	C65159	C65816	
3/8	16	UNC	.3750	1-1/2	1/2	C65208	C65855	
3/8	16	UNC	.3750	2	5/8	C65280	—	
3/8	24	UNF	.3750	1	3/8	C65160	C65817	
3/8	24	UNF	.3750	1-1/2	1/2	C65209	C65856	
3/8	24	UNF	.3750	2	5/8	C65281	—	
7/16	14	UNC	.4375	1	3/8	C65171	C65828	
7/16	14	UNC	.4375	1-1/2	1/2	C65220	C65865	
7/16	14	UNC	.4375	2	5/8	C65292	—	
7/16	20	UNF	.4375	1	3/8	C65172	C65829	
7/16	20	UNF	.4375	1-1/2	1/2	C65221	C65866	
7/16	20	UNF	.4375	2	5/8	C65293	—	

continued on next page

Styles: 0610, 0710 (continued)

die diameter TPI and series			decimal equiv.	outside diameter in		thickness in	order number	
							0610 carbon steel	0710 high-speed steel
1/2	13	UNC	.5000	1	3/8	C65470	—	
1/2	13	UNC	.5000	1-1/2	1/2	C65232	C65875	
1/2	13	UNC	.5000	2	5/8	C65303	—	
1/2	20	UNF	.5000	1	3/8	C65471	—	
1/2	20	UNF	.5000	1-1/2	1/2	C65233	C65876	
1/2	20	UNF	.5000	2	5/8	C65304	—	
9/16	12	UNC	.5625	1-1/2	1/2	C65239	C65881	
9/16	12	UNC	.5625	2	5/8	C65311	—	
9/16	18	UNF	.5625	1-1/2	1/2	C65240	C65882	
9/16	18	UNF	.5625	2	5/8	C65312	—	
5/8	11	UNC	.6250	1-1/2	1/2	C65243	C65884	
5/8	11	UNC	.6250	2	5/8	C65315	C65946	
5/8	11	UNC	.6250	2-1/2	3/4	C65374	—	
5/8	18	UNF	.6250	1-1/2	1/2	C65244	C65885	
5/8	18	UNF	.6250	2	5/8	C65316	C65947	
3/4	10	UNC	.7500	1-1/2	1/2	C65250	—	
3/4	10	UNC	.7500	2	5/8	C65328	C65957	
3/4	10	UNC	.7500	2-1/2	3/4	C65384	—	
3/4	16	UNF	.7500	1-1/2	1/2	C65251	—	
3/4	16	UNF	.7500	2	5/8	C65329	C65958	
3/4	16	UNF	.7500	2-1/2	3/4	C65385	—	
7/8	9	UNC	.8750	2	5/8	C65339	C65966	
7/8	9	UNC	.8750	2-1/2	3/4	C65395	—	
7/8	14	UNF	.8750	2	5/8	C65340	C65967	
7/8	14	UNF	.8750	2-1/2	3/4	C65396	—	
1	8	UNC	1.0000	2	5/8	C65349	—	
1	8	UNC	1.0000	2-1/2	3/4	C65405	—	
1	8	UNC	1.0000	3	1	C65416	—	
1	12	UNF	1.0000	2	5/8	C65350	—	
1	12	UNF	1.0000	2-1/2	3/4	C65406	—	
1	12	UNF	1.0000	3	1	C65417	—	
1	14	UNS	1.0000	2	5/8	C65407	—	
1-1/8	7	UNC	1.1250	3	1	C65426	—	
1-1/8	12	UNF	1.1250	3	1	C65427	—	
1-1/4	7	UNC	1.2500	3	1	C65433	—	
1-1/4	12	UNF	1.2500	3	1	C65434	—	
1-3/8	6	UNC	1.3750	3	1	C65441	—	
1-3/8	12	UNF	1.3750	3	1	C65442	—	
1-1/2	6	UNC	1.5000	3	1	C65449	—	
1-1/2	12	UNF	1.5000	3	1	C65450	—	

Dies

High Speed Steel
Style: 0620
Round Adjustable - Pipe
Inch

die diameter TPI and series			decimal equiv.	outside diameter in		thickness in	order number
							0620 carbon steel
1/8	27	NPT	.1250	1	3/8	C65491	
1/8	27	NPT	.1250	1-1/2	1/2	C65492	
1/4	18	NPT	.2500	1-1/2	1/2	C65493	
1/4	18	NPT	.2500	2	5/8	C65495	
3/8	18	NPT	.3750	1-1/2	1/2	C65494	
3/8	18	NPT	.3750	2	5/8	C69496	
1/2	14	NPT	.5000	2	5/8	C65497	

Pipe size round adjustable dies are not split.

HSS

Surface
Treatment

Bright

die diameter and TPI	decimal equiv.	outside diameter		thickness		order number
		in	mm	in	mm	0710M high-speed steel
M2.5 x 0.45	.0984	13/16	20.64	1/4	6.35	C65721
M3 x 0.5	.1181	13/16	20.64	1/4	6.35	C65724
M3.5 x 0.6	.1378	13/16	20.64	1/4	6.35	C65732
M4 x 0.7	.1575	13/16	20.64	1/4	6.35	C65737
M4.5 x 0.75	.1772	13/16	20.64	1/4	6.35	C65742
M5 x 0.8	.1969	13/16	20.64	1/4	6.35	C65747
M6 x 1	.2362	13/16	20.64	1/4	6.35	C65757
M6 x 1	.2362	1	25.40	3/8	9.53	C65801
M7 x 1	.2756	1	25.40	3/8	9.53	C65807
M8 x 1.25	.3150	1	25.40	3/8	9.53	C65813
M10 x 1.5	.3937	1	25.40	3/8	9.53	C65824
M12 x 1.75	.4724	1	25.40	3/8	9.53	C65833
M14 x 2	.5512	1-1/2	38.10	1/2	12.70	C65880
M16 x 2	.6300	1-1/2	38.10	1/2	12.70	C65889
M18 x 2.5	.7087	1-1/2	38.10	1/2	12.70	C65896
M20 x 2.5	.7874	1-1/2	38.10	1/2	12.70	C65901

Dies

High Speed Steel

Adjustable Dies

Die Stock - Round Adjustable

Styles: 222 & 224

Note

Style 222 holds round adjustable dies with three adjusting screws



Style 222 Die Stock

Note

Style 224 stocks have built-in workpiece guide and lock in place with two set screws

Special Note: This item will be **obsolete** once inventory is depleted.



Style 224 Die Stock

product number	die O.D.	overall length	order number
2	13/16	7	222 C67223
3	1	9-1/4	C67224
5	1-1/2	13-1/4	C67226
6	2	15-3/8	C67227
7	2-1/2	19-1/2	C67228
8	3	23	C67229

product number	die O.D.	overall length	order number
13	13/16	6-1/4	224 C67235
14	1	13	C67236
15	1-1/2	17-3/4	C67237
16	2	26	C67238

Steel Construction **Bright**
Surface Treatment
Bright

- **Style 0554** Quick-Set Two-Piece Die System consists of these parts:
 - Style 0550 — Die
 - Style 0551 — Cap
 - Style 0552 — Guide
 - Style 0553 — Collet
- Inch sizes are sold as a complete assembly or in their component parts.
- Metric sizes are sold in their component parts only.
- Use with Quick-Set die stocks.
- Collet assembly for use with Quick-Set dies consists of a cap and a guide; order cap and guide separately, or assembled as a collet.
- Die halves are seated in the beveled cap slot and held in place by the guide, which screws into the underside of the cap.
- Die is adjusted by the set screws at either end of the slot.
- Caps of a given outside diameter are made with several different sizes of slots.
- Separate guide is required for each cutting size.
- To order separate guides, specify cutting size of the die and the size of the collet for 1/4" and 1/2" dies.
- For metric sizes where guide and collet assembly are not available, use Style 225 Quick-Set Jr. die stock to hold dies.



Style 0554 Die Assembly



Style 0550 Die Halves

 Style 0553 Collet
 (combined Cap and Guide)

Style 0551 Cap



Style 0552 Guide

order number

nominal size TPI and series			decimal equiv.	0554 complete assembly	0550 die blank	0550 die halves	0553 no.	0553 collet	0551 O.D.	0551 cap	0552 guide
4	40	UNC	.1120	C66782	A1	C66693	A1	C66754	1.250	C66727	C66681
6	32	UNC	.1380	C66783	A1	C66694	A1	C66755	1.250	C66727	C66682
8	32	UNC	.1640	C66784	A1	C66695	A1	C66756	1.250	C66727	C66683
10	24	UNC	.1900	C66785	A1	C66696	A1	C66757	1.250	C66727	C66684
10	32	UNF	.1900	C66786	A1	C66697	A1	C66757	1.250	C66727	C66684
12	24	UNC	.2160	C66787	A1	C66698	A1	C66758	1.250	C66727	C66685
1/4	20	UNC	.2500	C66788	A1	C66699	A1	C66759	1.250	C66727	C66686
1/4	20	UNC	.2500	C66789	A	C66701	1	C66760	2.000	C66728	C66737
1/4	28	UNF	.2500	C66790	A	C66700	1	C66760	2.000	C66728	C66737
5/16	18	UNC	.3125	C66791	A	C66703	1	C66761	2.000	C66728	C66738
5/16	24	UNF	.3125	C66792	A	C66704	1	C66761	2.000	C66728	C66738
3/8	16	UNC	.3750	C66793	B	C66705	1	C66762	2.000	C66729	C66739
3/8	24	UNF	.3750	C66794	B	C66706	1	C66762	2.000	C66729	C66739
7/16	14	UNC	.4375	C66795	B	C66707	1	C66763	2.000	C66729	C66740
7/16	20	UNF	.4375	C66796	B	C66708	1	C66763	2.000	C66729	C66740
1/2	13	UNC	.5000	C66797	B	C66709	1	C66764	2.000	C66729	C66741
1/2	20	UNF	.5000	C66798	B	C66711	1	C66764	2.000	C66729	C66741
1/2	13	UNC	.5000	C66801	C	C66710	5	C66769	2.750	C66732	C66746
1/2	20	UNF	.5000	C66802	C	C66712	5	C66769	2.750	C66732	C66746
9/16	12	UNC	.5625	C66803	C	C66713	5	C66770	2.750	C66732	C66747
9/16	18	UNF	.5625	C66804	C	C66714	5	C66770	2.750	C66732	C66747
5/8	11	UNC	.6250	C66805	C	C66715	5	C66771	2.750	C66732	C66748
5/8	18	UNF	.6250	C66806	C	C66716	5	C66771	2.750	C66732	C66748
3/4	10	UNC	.7500	C66807	C	C66717	5	C66772	2.750	C66732	C66749
3/4	16	UNF	.7500	C66808	C	C66718	5	C66772	2.750	C66732	C66749
7/8	9	UNC	.8750	C66809	D	C66719	5	C66773	2.750	C66733	C66750
7/8	14	UNF	.8750	C66810	D	C66720	5	C66773	2.750	C66733	C66750
1	8	UNC	1.0000	C66811	D	C66721	5	C66774	2.750	C66733	C66751
1	12	UNF	1.0000	C66812	D	C66722	5	C66774	2.750	C66733	C66751
1	14	UNS	1.0000	C66813	D	C66723	5	C66774	2.750	C66733	C66751

continued on next page

Die Set

Quick Set - Metric

Styles: **0550, 0551, 0552, 0553** (continued)

nominal size TPI	decimal equiv.	order number						
		0550		0553		0551	0552	
		die blank	die halves	no.	collet	cap	O.D.	guide
M6 x 1	.2362	A	C66670	5	*	*	2.750	C66820
M8 x 1.25	.3150	A	C66671	5	*	*	2.750	C66821
M10 x 1.5	.3937	B	C66672	5	*	*	2.750	C66822
M12 x 1.75	.4724	B	C66673	5	*	*	2.750	C66823
M14 x 2	.5512	C	C66674	5	C66769	C66732	2.750	C66824
M16 x 2	.6300	C	C66675	5	C66770	C66732	2.750	C66825
M18 x 2.5	.7087	C	C66676	5	C66771	C66732	2.750	C66826
M20 x 2.5	.7874	C	C66677	5	C66772	C66732	2.750	C66827
M22 x 2.5	.8661	D	C66678	5	C66773	C66733	2.750	C66828
M24 x 3	.9449	D	C66679	5	C66774	C66733	2.750	C66829

*Use Style 225 Quick-Set Jr. die stock instead of collet assembly for these sizes.

Dies

Die Set

Accessories

Styles: **223, 225**

Surface
Treatment



Style 223 - Regular Quick-Set Die Stock

Carbon Steel Black Oxide

- Use with all Series 0554 Quick-Set collets with two-piece dies.
- Quick-Set die stocks have center holes corresponding to the outside diameter of the Quick-Set collets.



Style 223
Regular Quick-
Set Die Stock

stock no.	collet no.	collet capacity	length of stock	order no. 223 stock
#A1	A1	1-1/4	7-1/2	C67216
#1	1	2	14-1/2	C67214
#5	5	2-3/4	23	C67217
#5A	5	2-3/4	26	C67215

Style 225 - Jr. Quick-Set Die Stock

Carbon Steel Black Oxide

- Use with all Series 0550 Quick-Set two-piece dies without collet.
- Quick-Set Jr. die stocks are designed to use Quick-Set dies without collets.
- Double slots enable use of two different size blanks in the same stock.
- Dies fit directly into the stock and are held in place by a screw guide.

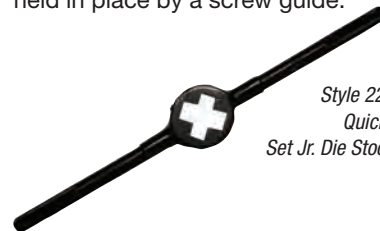

Style 225
Quick-
Set Jr. Die Stock

stock no.	cutting size	die blank size	guide no.	cutting size range	length of stock	order no. 225 stock
#1	1/4 to 5/16	A	1	1/4 to 1/2	14-1/2	C67220
	3/8 to 1/2	B				
#5	9/16 to 3/4	C	5	9/16 to 1	26	C67221
	7/8 to 1	D				

Quick-Set

Spanner Wrench

Style: **226**

stock no.	collet no.	collet capacity	order no. 226 stock
#A1	A1	1-1/4	C67232

- Since A1 guides are so small they are round not square, so you cannot use a standard wrench.
- Fits into two holes to turn guide.

Styles: 240, 242, 243, 244, 245
Tap Wrenches
Style: 240
Standard Straight

product number	mach screw	tap size ranges		pipe	overall length	order number
		fractional	metric			240
0	0 to 14	1/16 to 1/4	M1.5 to M6.3	—	7	C67201
14	0 to 14	1/16 to 3/8	M1.5 to M10	—	9	C67197
5	8 to 14	5/32 to 1/2	M4 to M12.5	1/8	11	C67202
6	8 to 14	5/32 to 3/4	M4 to M19	1/8 to 1/4	15	C67203
7	—	1/4 to 1-1/8	M12 to M28	1/8 to 3/4	19	C67204
8	—	3/4 to 1-5/8	M19 to M40	3/8 to 1-1/4	40	C67205
22	—	1 to 2-1/2	M25 to M56	3/4 to 2	54	C67200

Note
Used for hand tapping.

Style: 242
Plain T-Handle

product number	mach screw	tap size ranges		overall length	order number
		fractional	metric		242
T9	0 to 14	1/16 to 1/4	M1.5 to M6.3	2-3/4	C67206
T10	12 to 14	7/32 to 1/2	M5.5 to M12.5	3-5/8	C67207

Note
Used for hand tapping in out-in-the-open jobs.

Style: 243
Slip T-Handle

product number	mach screw	tap size ranges		overall length	order number
		fractional	metric		243
T11	0 to 14	1/16 to 1/4	M1.5 to M6.3	2-3/4	C67208
T12	12 to 14	7/32 to 1/2	M5.5 to M12.5	3-5/8	C67209

Note
Used for hand tapping or in difficult spaces requiring a slip handle.

Style: 244
Combination Ratchet and Slip Handle

product number	mach screw	tap size ranges		overall length	order number
		fractional	metric		244
T13	0 to 14	1/16 to 1/4	M1.5 to M6.3	3-3/4	C67210
T14	12 to 14	7/32 to 1/2	M5.5 to M12.5	5	C67211

Note
Used for hand tapping in difficult spaces needing ratchet drive.

Style: 245 Long Shank T-Handle Tap Wrench
Long Shank T-Handle

product number	mach screw	tap size ranges		overall length	order number
		fractional	metric		245
T16	0 to 14	1/16 to 1/4	M1.5 to M6.3	8-3/4	C67212
T17	12 to 14	7/32 to 1/2	M5.5 to M12.5	10-5/8	C67213

Note
Used for hand tapping where extra reach is required.



Cost Saving Sets

General Purpose Tap

				Number of pieces	Surface Treatment	H-Limit	Size Range	Case Type	
Type	Style	Order No.	Bright		Inch		Metal	Plastic	
	General Purpose	1002	C55090	10	•	yes	UNC: 1/4-20, 5/16-18, 3/8-16, 7/16-14, 1/2-13 UNF: 1/4-28, 5/16-24, 3/8-24, 7/16-20, 1/2-20	•	



Dies - Inch

						Size Range		Case Type	
Type	Style	Order No.	Number of Sizes	Set Number	Inch		Metal	Plastic	
	General Purpose	0650	C67275	8	42NC	1/4-20 NC 5/16-18 NC 3/8-16 NC 7/16-14 NC	1/2-13 NC 9/16-12 NC 5/8-11 NC 3/4-10 NC	•	
			C67276	8	42NF	1/4-28 NF 5/16-24 NF 3/8-24 NF 7/16-20 NF	1/2-20 NF 9/16-18 NF 5/8-18 NF 3/4-16 NF	•	
			C67278	10	44NC	1/4-20 NC 5/16-18 NC 3/8-16 NC 7/16-14 NC 1/2-13 NC	9/16-12 NC 5/8-11 NC 3/4-10 NC 7/8-9 NC 1-8 NC	•	
			C67284	10	NCNF	1/4-20 NC 5/16-18 NC 3/8-16 NC 7/16-14 NC 1/2-13 NC	1/4-28 NF 5/16-24 NF 3/8-24 NF 7/16-20 NF 1/2-20 NF	•	
			C67282	20	45NCNF	1/4-20 NC 5/16-18 NC 3/8-16 NC 7/16-14 NC 1/2-13 NC 9/16-12 NC 5/8-11 NC 3/4-10 NC 7/8-9 NC 1-8 NC	1/4-28 NF 5/16-24 NF 3/8-24 NF 7/16-20 NF 1/2-20 NF 9/16-18 NF 5/8-18 NF 3/4-16 NF 7/8-14 NF 1-14 NF	•	



Set C67275



Set C67276



Set C67278



Set C67282

Dies - Metric

					Size Range		Case Type		
Drill Type	Style Number	Order No.	Number of Sizes	Set Number	Metric		Metal	Plastic	
	General Purpose	0650M	C67283	7	49Metric	M6 x 1 M8 x 1.25 M10 x 1.5 M12 x 1.75	M14 x 2 M16 x 2 M20 x 2.5	•	





Gauging Threaded Holes

To confirm the accuracy of a tapped hole, always use a Go-No Go gauge. Never use a fastener i.e.: (screw, or bolt) Using a screw, or bolt will not allow you to verify size of the thread produced, but only indicate that the bolt used will fit in that particular hole. Go-No Gauges can give indications as to where the thread produced is within the thread specification. A screw or bolt is not capable of giving such an indication. Accurate gauges will also help predict remaining tool life by indicating tightness or looseness of the gage in the part.



NPT vs. NPTF Taper Pipe Threads

The two most common taper pipe threads used in the United States are NPT and NPTF. Applications range from electrical conduits and hand railings to high-pressure pipe lines that carry gas or caustic fluids. NPT threads are for mechanical or low-pressure air or fluid applications and require the use of sealing compounds like Teflon tape, to provide the seal. When the application is more critical, and the sealing compound may fail due to high heat or pressure, NPTF Dryseal threads are used. This mechanical seal is produced by the mating and slight crushing of the threads when a wrench is applied to tighten the fittings.

Visually, both threads appear to be identical. Both have a $\frac{3}{4}$ " taper over one foot of length. Both have the same pitch diameter at the top of the hole of internal threads or end of the pipe on external threads, and both have the same thread lengths or depths. However, there is a subtle difference in the thread form that differentiates the two. The major and minor diameters of both threads are differ slightly. With NPT threads, after a wrench is applied, slight spaces at the major and minor diameters may exist that would allow the assembly to leak and therefore a sealing compound is used to fill any gaps. On the other hand, NPTF threads are designed to ensure that sufficient crushing of the entire thread form will take place to produce a mechanical seal.

How does the difference in thread forms effect the tooling used to produce NPT and NPTF threads? Taps are available for both NPT and NPTF threads having the appropriate form to produce each type of thread. Since NPT threaded parts require sealing compounds, it is acceptable to use an NPTF tap for NPT applications. However, NPT taps cannot be used for NPTF applications, as it will likely produce a thread that will leak. The same is true of external threads. In most cases the tap drill is the same for both forms.

The most significant difference in the two threads is the inspection required. Since sealing compounds will be used for NPT threads, only a single plug with a step, known as an L1 plug (internal thread) or a single thin L1 ring (external) are required to check size. However, since the taper and the position of major and minor diameters are so critical to the sealing of NPTF threads, the additional threads in the assembly known as L2 and L3, and the major and minor diameters are inspected with either special plug or ring gauges.



Technical Information

Tap Nomenclature / Chamfers	204	USCTI Table 311	214
Tap and Drill Recommendations	206	USCTI Table 327	215
Hardness Conversion Table	207	USCTI Table 329	216
Standard Tap Marking Systems	208	USCTI Table 331	217
Application Data		USCTI Table 341	218
Progress / Performance Taps	209	USCTI Table 352	219
Tapping Speed	210	Thread Mill Operating Parameters	222
USCTI Table 302	212	Made to Order, Special Taps, FastTap	223
USCTI Table 302A	213		

Tap Nomenclature

Bottoming Tap

A tap having a chamfer length of 1-2 threads.

Chamfer

The tapering of the threads at the front end of each land of a chaser, tap or die by cutting away and relieving the crest of the first few teeth to distribute the cutting action over several teeth.

Chamfer Angle

The angle formed between the chamfer and the axis of the tap or die by cutting away and relieving the crest of the first few teeth to distribute the cutting action over several teeth.

Crest

The surface of the thread which joins the flanks of the thread and is farthest from the cylinder or cone from which the thread projects.

Flank

The part of a helical thread surface which connects the crest and the root and which is theoretically a straight line in an axial plane section.

Flute

The longitudinal channel formed in a tap to create cutting edges on the thread profile and to provide chip spaces and cutting fluid passage.

Hand of Threads

A thread, when viewed axially, winds in a clockwise and receding direction for LEFT-HAND THREADS and counter-clockwise and receding direction for RIGHT-HAND THREADS.

Hook, Chordal

A concave face having an angle of inclination specified between a chord passing through the root and crest of a thread form at the cutting face, and a radial line through the crest at the cutting edge.

Hook, Tangential

A concave face having an angle of inclination specified between a line tangent to the hook surface at the cutting edge and a radial line to the same point.

continued on next page

Illustration of Tap Terms

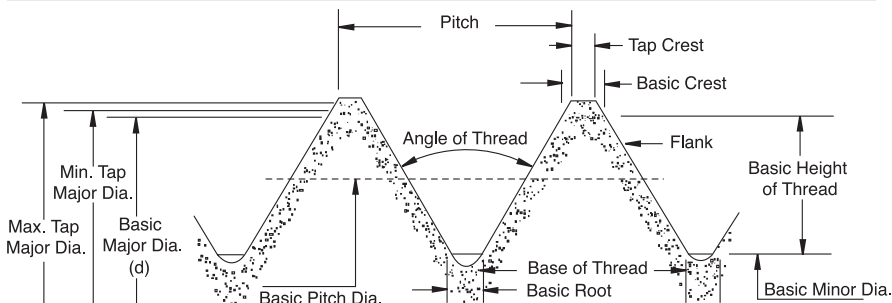

Tap Chamfers

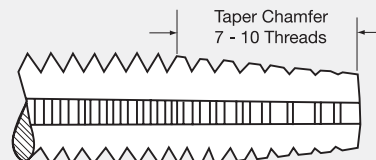

Taper (7 to 10 pitches)

The taper chamfer has the longest standard chamfer ensuring easier starting. It requires less tapping torque because of more working teeth.

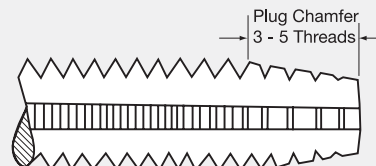

Plug (3 to 5 pitches)

The most common chamfer for use by hand or machine in through or blind holes. This chamfer is more efficient than a bottoming or modified-bottoming chamfer.

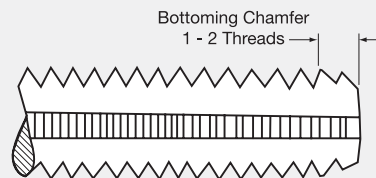

Bottoming (1 to 2 pitches)

For threading close to the bottom of blind holes, the bottoming chamfer is the least efficient chamfer available.

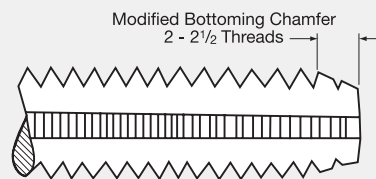

Modified-Bottoming (2 to 2 1/2 pitches)

This short chamfer allows for threading close to the bottom of blind holes. Due to the slightly longer chamfer and more working teeth, this chamfer is more efficient than a bottoming chamfer.

Hook Angle

The angle of inclination of a concave face, usually specified either as CHORDAL HOOK or TANGENTIAL HOOK.

Interrupted Thread Tap

A tap having an odd number of lands with alternate teeth in the thread helix removed. In some cases alternate teeth are removed only for a portion of the thread length.

Land

One of the threaded sections between the flutes of a tap.

Lead of Thread

The distance a screw thread advances axially in one complete turn. On a single start tap the lead and pitch are identical. On a multiple start tap the lead is the multiple of the pitch.

Major Diameter

The diameter of the major cylinder or cone, at a given position on the axis, that bounds the crests of an external thread or the roots of an internal thread.

Minor Diameter

The diameter of the minor cylinder or cone, at a given position on the axis, that bounds the roots of an external thread or the crests of an internal thread.

Pitch Diameter

The diameter of an imaginary cylinder or cone, at a given point on the axis, of such a diameter and location of its axis that its surface would pass through the thread in such a manner as to make the thread ridge and the thread groove equal and, therefore, is located equidistant between the sharp major and minor cylinders or cones of a given thread form. On a theoretically perfect thread, these widths are equal to one half of the basic pitch (measured parallel to the axis). See illustration below

Plug Tap

A tap with 3 to 5 chamfered threads.

Spiral Point

The angular fluting in the cutting face of the land at the chamfered end. It is formed at an angle with respect to the tap axis of opposite hand to that of rotation. Its length is usually greater than the chamfer length and its angle with respect to the tap axis is usually made great enough to direct the chips ahead of the tap. The tap may or may not have longitudinal flutes.

Square

Four driving flats parallel to the axis on a tap shank forming a square or square with round corners.

Taper Tap

A tap having a chamfer length of 7 to 10 threads.

Pitch Diameter

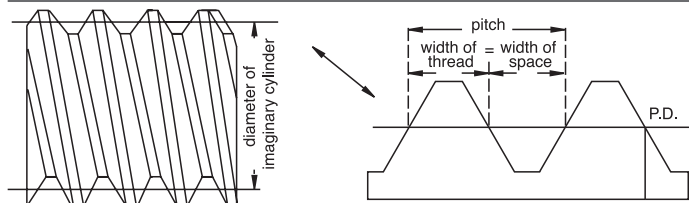

Tap End Views

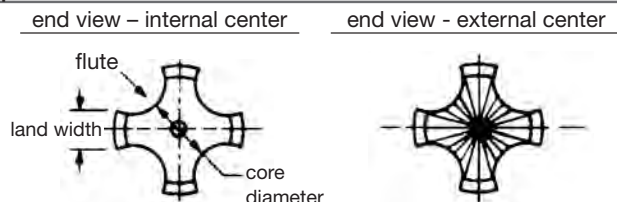

Screw Thread Tolerances

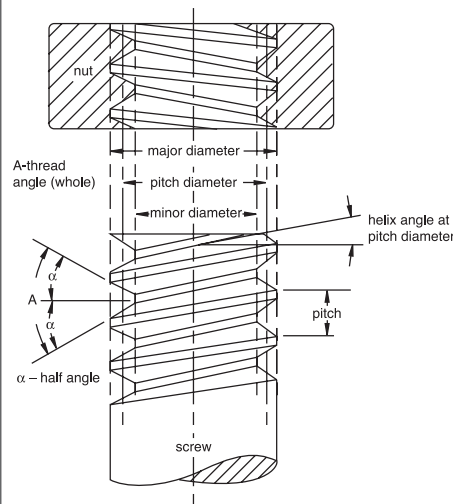

It is generally recognized that, in mass production, it is impossible to reproduce in exact detail the theoretically perfect product as laid out on the drawing board. The allowed slight variation between the theoretically perfect product and each unit of the actual product is called the TOLERANCE.

Allowance - An intentional difference in correlated dimensions of mating parts. It is the minimum clearance or maximum interference between such parts.

Angle of Thread - The angle included between the flanks of the thread measured in an axial plane.

Half Angle of Thread - The angle included between a flank of the thread and the normal (90°) to the axis, measured in an axial plane.

Lead of Thread - The distance a screw thread advances axially in one turn. On a single-thread screw the lead and pitch are identical. On a double thread the lead is 2X pitch, on a triple thread the lead is 3X pitch, etc.

Major Diameter - The largest diameter of a straight screw thread.

Minor Diameter - The smallest diameter of a straight screw thread.

Pitch - The distance from a point on a screw thread to a corresponding point on the next thread measured parallel to the axis.

$$\text{The pitch in inches} = \frac{1}{\text{no. of threads per inch}}$$



Inch Sizes (measurements in inches)

tap size and pitch	cutting taps drill size	decimal equiv	forming taps drill size	decimal equiv.
0-80	3/64	.0469	54	.0550
1-64	53	.0595	51	.0670
1-72	53	.0595	51	.0670
2-56	50	.0700	5/64	.0781
2-64	50	.0700	47	.0785
3-48	47	.0785	43	.0890
3-56	46	.0810	2.30	.0905
4-40	43	.0890	38	.1015
4-48	42	.0935	2.60	.1024
5-40	38	.1015	33	.1130
5-44	37	.1040	2.90	.1142
6-32	36	.1065	1/8	.1250
6-40	33	.1130	3.25	.1280
8-32	29	.1360	25	.1495
8-36	29	.1360	24	.1520
10-24	26	.1470	11/64	.1719
10-32	21	.1590	16	.1770
12-24	16	.1770	8	.1990
12-28	15	.1800	7	.2010
1/4-20	7	.2010	1	.2280
1/4-28	3	.2130	15/64	.2340
5/16-18	F	.2570	L	.2900
5/16-24	I	.2720	M	.2950
3/8-16	5/16	.3125	S	.3480
3/8-24	Q	.3320	T	.3580
7/16-14	U	.3680	Y	.4040
7/16-20	25/64	.3906	Z	.4130
1/2-13	27/64	.4219	15/32	.4682
1/2-20	29/64	.4531	12.25	.4823
9/16-12	31/64	.4844	17/32	.5312
9/16-18	33/64	.5156	13.50	.5315
5/8-11	17/32	.5312	14.75	.5807
5/8-18	37/64	.5781	15.25	.6004
3/4-10	21/32	.6562	45/64	.7031
3/4-16	11/16	.6875	23/32	.7188
7/8-9	49/64	.7656	*	*
7/8-14	13/16	.8125	*	*
1-8	7/8	.8750	*	*
1-12	59/64	.9219	*	*
1-1/8 - 7	63/64	.9844	*	*
1-1/8 - 12	1 3/64	1.0469	*	*
1-1/4 - 7	1 7/64	1.1094	*	*
1-1/4 - 12	1 11/64	1.1719	*	*
1-3/8 - 6	1 7/32	1.2188	*	*
1-3/8 - 12	1 19/64	1.2969	*	*
1-1/2 - 6	1 11/32	1.3438	*	*
1-1/2 - 12	1 27/64	1.4219	*	*

Metric Sizes (measurements in millimeters and inches)

tap size and pitch	cutting taps drill size (mm)	decimal equiv (in)	forming taps drill size (mm)	decimal equiv. (in)
M1.6 x 0.35	1.25	.0492	1.45	.0571
M1.8 x 0.35	1.45	.0571	1.65	.0650
M2 x 0.40	1.60	.0630	1.80	.0709
M2.2 x 0.45	1.75	.0689	2.00	.0787
M2.5 x 0.45	2.05	.0807	2.30	.0906
M3 x 0.50	2.50	.0984	7/64	.1094
M3.5 x 0.60	2.90	.1142	3.20	.1260
M4 x 0.70	3.30	.1299	3.70	.1476
M4.5 x 0.75	3.70	.1476	4.10	.1614
M5 x 0.80	4.20	.1654	14	.1820
M6 x 1.00	5.00	.1969	7/32	.2188
M7 x 1.00	6.00	.2362	F	.2570
M8 x 1.25	6.70	.2638	7.40	.2913
M8 x 1.00	7.00	.2756	19/64	.2969
M10 x 1.50	8.50	.3346	U	.3680
M10 x 1.25	8.70	.3425	9.40	.3701
M12 x 1.75	10.20	.4016	11.20	.4409
M12 x 1.25	10.80	.4252	11.50	.4528
M14 x 2.00	12.00	.4724	33/64	.5156
M16 x 2.00	14.00	.5512	19/32	.5938
M16 x 1.50	14.50	.5709	15.25	.6004
M18 x 2.50	15.50	.6102	39/64	.6094
M18 x 1.50	16.50	.6496	17.25	.6791
M20 x 2.50	17.50	.6890	*	*
M20 x 1.50	18.50	.7283	*	*
M22 x 2.50	19.50	.7677	*	*
M22 x 1.50	20.50	.8071	*	*
M24 x 3.00	21.00	.8268	*	*
M24 x 2.00	22.00	.8661	*	*
M27 x 3.00	24.00	.9449	*	*
M27 x 2.00	25.00	.9843	*	*
M30 x 3.50	26.50	1.0433	*	*
M30 x 2.00	28.00	1.1024	*	*
M33 x 3.50	29.50	1.1614	*	*
M33 x 2.00	31.00	1.2205	*	*
M36 x 4.00	32.00	1.2598	*	*
M36 x 3.00	33.00	1.2992	*	*
M39 x 4.00	35.00	1.3780	*	*
M39 x 3.00	36.00	1.4173	*	*

Pipe Tap Sizes (measurements in millimeters and inches)

nominal pipe tap size	NPT & NPTF		NPSM	NPSC	NPSF
	without reamer	with reamer			
1/16-27	C (.242)	A (.234)	—	.250	D (.246)
1/8-27	Q (.332)	21/64	T (.358)	Q (.332)	R (.339)
1/4-18	7/16	27/64	15/32	7/16	7/16
3/8-18	9/16	9/16	.603 (special)	37/64	37/64
1/2-14	45/64	11/16	19,0 mm	18,0 mm	18,0 mm
3/4-14	29/32	57/64	61/64	59/64	59/64
1 - 11-1/2	1-9/64	1-1/8	1-13/64	1-5/32	1-5/32
1-1/4-11-1/2	1-31/64	1-15/32	1-35/64	1-1/2	—
1-1/2 - 11-1/2	1-23/32	1-45/64	1-25/32	1-47/64	—
2 - 11-1/2	2-3/16	2-11/64	2-1/4	2-13/64	—

* Contact Technical Service for recommendations.
Hole sizes shown may not suit UNJ and MJ hole requirements.

TECHNICAL High Speed Steel



Technical Information

Use this table to match the hardness of your workpiece material to the correct tap.

10 M/M Ball 3000 Kg	120° Cone 150 Kg	1/16" Ball 100 Kg	Model C	1000 Lb. per Sq. In.	10 M/M Ball 3000 Kg	120° Cone 150 Kg	1/16" Ball 100 Kg	Model C	1000 Lb. per Sq. In.
Brinell	Rockwell C	Rockwell B	Shore Scleroscope	Tensile Strength	Brinell	Rockwell C	Rockwell B	Shore Scleroscope	Tensile Strength
800	72	—	100	—	276	30	105	42	136
780	71	—	99	—	269	29	104	41	132
760	70	—	98	—	261	28	103	40	129
745	68	—	97	367	258	27	102	39	127
725	67	—	96	357	255	26	102	39	125
712	66	—	95	350	249	25	101	38	123
682	65	—	93	337	245	24	100	37	119
668	64	—	91	326	240	23	99	36	117
652	63	—	89	318	237	23	99	35	115
626	62	—	87	306	229	22	98	34	113
614	61	—	85	299	224	21	97	33	110
601	60	—	83	292	217	20	96	33	107
590	59	—	81	290	211	19	95	32	104
576	57	—	79	281	206	18	94	32	102
552	56	—	76	270	203	17	94	31	100
545	55	—	75	268	200	16	93	31	98
529	54	—	74	259	196	15	92	30	96
514	53	120	72	254	191	14	92	30	94
502	52	119	70	247	187	13	91	29	92
495	51	119	69	244	185	12	91	29	91
477	49	118	67	233	183	11	90	28	90
461	48	117	66	227	180	10	89	28	89
451	47	117	65	223	175	9	88	27	86
444	46	116	64	219	170	7	87	27	84
427	45	115	62	209	167	6	87	27	82
415	44	115	60	204	165	5	86	26	81
401	43	114	58	196	163	4	85	26	80
388	42	114	57	191	160	3	84	25	78
375	41	113	55	184	156	2	83	25	76
370	40	112	54	182	154	1	82	25	75
362	39	111	53	179	152	—	82	24	74
351	38	111	51	173	150	—	81	24	74
346	37	110	50	170	147	—	80	24	72
341	37	110	49	168	145	—	79	23	71
331	36	109	47	163	143	—	79	23	70
323	35	109	46	158	141	—	78	23	69
311	34	108	46	153	140	—	77	22	69
301	33	107	45	148	135	—	75	22	67
293	32	106	44	144	130	—	72	22	65
285	31	105	43	140					

TECHNICAL

High Speed Steel

Taps, dies, and other threading tools will be marked with the nominal size, number of threads per inch, and the proper symbol to identify the thread form. The symbols below are in agreement with the ASME B1.7 1965 (R 1972) Standard on nomenclature, definitions and letter symbols for screw threads and other national standards.

Symbol	Reference
ACME-C	Acme Thread-Centralizing
ACME-G	Acme Thread-General Purpose
AMO	American Standard Microscope Objective Thread
ANPT	Aeronautical National Form Taper Pipe Thread (Ground Thread Tap marked NPT)
BA	British Association Standard Thread
BSF	British Standard Fine Thread Series
BSPP	British Standard Pipe (Parallel) Thread
BSPT	British Standard Taper Pipe Thread
BSW	British Standard Whitworth Coarse Thread Series
M	Metric Standard Threads
N	American National 8, 12 and 16 Thread Series (8N, 12N, 16N)
N BUTT	American Buttress Thread
NC	American National Coarse Thread Series
NEF	American National Extra-Fine Thread Series
NF	American National Fine Thread Series
NGO	National Gas Outlet Thread (specify right or left hand)
NGS	National Gas Straight Thread
NGT	National Gas Taper Thread (See also "SGT")
NH	American National Hose Coupling & Firehose Coupling Threads
NPS	For Tap marking Only (See NPSC, NPSM)
NPSC	American National Standard Straight Pipe Thread in Pipe Couplings (Tap Marked NPS)
NPSF	Dryseal American National Standard Fuel Internal Straight Pipe Thread
NPSH	American National Standard Straight Pipe Thread for Hose Couplings
NPSI	Dryseal American National Standard Intermediate Internal Straight Pipe Thread
NPSL	American National Standard Straight Pipe Thread for Loose-Fitting Mechanical Joints with locknuts.
NPSM	American National Standard Straight Pipe Threads for Free-Fitting Mechanical Joints for Fixtures (Tap Marked NPS)"
NPT	American National Standard Taper Pipe Thread (see ANPT, NPTR)

Symbol	Reference
NPTF	Dryseal American National Standard Taper Pipe Thread
NPTR	American National Standard Taper Pipe Thread for Railing Joints (Tap Marked NPT)
NR	American National Thread with a 0.108p to 0.144p Controlled Root Radius
NS	American National Thread-Special
PTF-SAE	Short Dryseal SAE Short Taper Pipe Thread
SGT	Special Gas Taper Thread
SPL-PTF	Dryseal Special Taper Pipe Thread
STI	Special Thread for Helical Coil Wire Screw Thread Inserts
Stub Acme	Stub Acme Thread
*UN	Unified Constant-Pitch Thread Series
*UNC	Unified Coarse Thread Series
*UNEF	Unified Extra-Fine Thread Series
*UNF	Unified Fine Thread Series
UNJ	Unified Thread Series with a 0.150llp to 0.18042p Controlled Root Radius on External Thread only.
UNJC	Unified Coarse Thread Series with a 0.150llp to 0.18042p Controlled Root Radius on External Thread only.
UNJF	Unified Fine Thread Series with a 0.150llp to 0.18042p Controlled Root Radius on External Thread only.
UNM	Unified Miniature Thread Series
UNR	Unified Constant-pitch Thread Series with a 0.108p to 0.144p Controlled Root Radius
UNRC	Unified Coarse Thread Series with a 0.108p to 0.144p Controlled Root Radius
UNRF	Unified Fine Thread Series with a 0.108p to 0.144p Controlled Root Radius
*UNS	Unified Thread-Special
V	A 60 "V" thread with Truncated Crest and Root. The theoretical "V" Form is usually flatted to the user's specifications.

*Taps are not marked with "U", but with the symbol for the corresponding American Standard thread form with which it is compatible.

These taps were developed for the highest cutting performance to cope with the increasing demands placed on industrial thread cutting. By optimizing the cutting geometry, substrate material, and surface treatment the tap will achieve the best results in CNC as well as in conventional thread cutting environments.

Our **Progress series** of taps are designed to be a "Universal" tool that performs well in a wide range of Steel Alloys as well as Stainless Steels and Ductile Irons. Our **Performance series** of taps are designed for those difficult jobs including Stainless Steels but work well in Steel Alloys and Ductile Irons.

Material		Application <i>1 = First Choice, 2 = Second Choice, (3) = Also Suitable</i>			Tapping Speed (SFM) <i>Vc = SFM RPM = (SFM/Diameter) x 3.82</i>		
		Black Oxide	TiAIN	Hardlube	Black Oxide	TiAIN	Hardlube
		Structural steels < 1000 N/mm ²	G01		1		40
Structural steels > 1000 N/mm ²	G02		(3)	1	27	40	42
Case hardening steels < 1000 N/mm ²	G03		2	1	33	66	70
Case hardening steels > 1000 N/mm ²	G04		(3)	1	20	33	35
Heat treatable steels < 1000 N/mm ²	G05		2	1	20	46	49
Heat treatable steels > 1000 N/mm ²	G06		(3)	1	14	27	29
Nitriding steels	G07	(3)	2	1	14	27	29
Carbon tool steels	G08		1	2	20	30	32
Heat Resisting Steels < 1400 N/mm ²	G09	(3)	(3)	1	14	23	25
Cr Stainless Steels, Sulphured	G10	(3)	(3)	1	20	33	35
Cr Stainless Steels, Ferric & Martensitic	G11	(3)	(3)	1	20	33	35
Cr-Ni Stainless Steels, Austenitic	G12	(3)	(3)	1	17	27	29
Free Cutting Steels	G13		1		46	79	83
Cast Steels < 1000 N/mm ²	G14		1		33	53	56
Cast Steels > 900 N/mm ²	G15		2	1	20	27	29
Malleable Cast Iron	G16		(3)		33	53	56
Nodular Graphite Cast Iron	G17		(3)		40	53	56
Lamellar Graphite Cast Iron (Grey Cast Iron)	G18		(3)		33	46	49
Vermicular Graphite Cast Iron	G19		(3)		40	53	56
Copper	G20		(3)		33	53	56
Hard Brass -- Short Chipping	G21		(3)		66	115	121
Soft Brass -- Long Chipping	G22		(3)		60	109	115
Red Brass	G23		(3)		33	60	63
Phosphor Bronze	G24		(3)		40	69	73
Aluminum Alloy - Wrought	G25		(3)		50	79	83
Aluminum Alloy - Cast (0.5% to 5% Silicon)	G26		(3)		66	86	91
Aluminum Alloy - Cast (5% to 10% Silicon)	G27		(3)		66	86	91
Aluminum Alloy - Cast (> 10% Silicon)	G28		(3)		66	86	91
Magnesium Alloy - Wrought	G29		(3)		50	79	83
Magnesium Alloy - Cast	G30		(3)		66	86	91
Nickel Alloy	G31		(3)		14	20	21
Titanium Alloy	G32		(3)		14	20	21
Ferro - TiC	G33		(3)		14	20	21
Thermoplastic Compounds/Synthetics	G34		(3)		66	66	70
High Strength Structural Steels - Fine Grained	G35		(3)		20	33	35

Consider these factors when trying to determine the best tapping speeds.

- Material to be tapped
- Length of chamfer on tap
- Percentage of full thread to be cut
- Length of hole (depth of thread)
- Pitch of thread
- Cutting fluids
- Machine equipment
- Horizontal or vertical tapping

The best and most efficient operating speeds for taps cannot be calculated with the same certainty as for many other metalcutting tools. With other tools, the feed per revolution can be set at any desired point and can be varied as conditions demand. Taps, on the other hand, must always be advanced at a rate equal to one pitch for every revolution. The style of tap may vary the conditions. For example, with a bottoming tap, the first thread on each land cuts the full height of thread, while, with a taper or starting tap, a number of threads do their share of the cutting before the full height of thread is reached.

The depth of thread also varies, depending on the pitch. The coarser the thread, the greater the advance of the tap per revolution and the greater the amount of material removed.

The method of feeding the tap, and the type of equipment for driving, also influence the permissible speeds. If taps are mechanically fed at the proper rate of advance, they can be operated at higher speeds than if they are required to feed themselves and pull some part of the machine along with them.

Speeds may be modified to take into account any or all of the factors listed above. Speeds must be lowered as the length of thread increases, because, in deep thread holes, the accumulated chips increase friction and interfere with lubrication.

Bottoming taps must be run slower than plug taps.

Tapping of full height of thread calls for slower speed than if the commercial 75% height only is required.

Coarse-thread taps in the larger diameters should be run more slowly than fine-thread taps of the same diameters.

The quantity and quality of cutting fluid may affect the permissible speeds as much as 100%.

Taper threaded taps, such as pipe taps, should be operated from 1/2 to 3/4 the speed of a straight thread tap of comparable major diameter.

Tapping Definitions

- SFM = Surface Feet per Minute
- RPM = Revolutions Per Minute
- IPM = Inches Per Minute
- TPI = Threads Per Inch
- S m/m = Surface Meters per Minute
- $p = 3.1416$
- mm/m = Millimeters per Minute
- P = Pitch (1/ No of Threads Per Inch)

Tapping Formula

Inch Sizes

- SFM = $(\text{RPM} \times \text{tool diameter}) / 3.82$
or $0.262 \times \text{RPM} \times \text{tool diameter}$
- RPM = $(3.82 \times \text{SFM}) / \text{tool diameter}$
- IPM = $\text{RPM} / \text{TPI}^*$
or $*P \times \text{RPM}$

Metric Sizes

- S m/m = $(p \times \text{tool diameter} \times \text{RPM}) / 1000$
- RPM = $(\text{m/m} \times 1000) / p \times \text{tool diameter}$
- mm/m = $\text{mm P} \times \text{RPM}$



Technical Information

Tapping Speeds

UNC/UNF and NPT/NPTF Sizes

UNC UNF Tap Size	NPT NPTF Taper Pipe	Surface Feet per Minute (SFM)																	
		5'	10'	15'	20'	25'	30'	40'	50'	60'	70'	80'	90'	100'	110'	120'	130'	140'	150'
0		318	637	955	1273	1592	1910	2546	3183	3820	4456	5093	5729	6366	7003	7639	8276	8913	9549
1		273	546	819	1046	1308	1570	2093	2617	3140	3663	4186	4710	5233	5756	6279	6805	7326	1849
2		212	424	637	888	1110	1333	1777	2221	2665	3109	3554	3999	4442	4886	5330	5774	6218	6662
3		191	382	573	772	964	1157	1543	1929	2315	2701	3086	3472	3858	4244	4629	5015	5401	5787
4		174	347	521	682	853	1023	1364	1705	2046	2387	2728	3069	3411	3751	4092	4434	4775	5115
5		147	294	441	611	764	917	1222	1528	1833	2139	2445	2750	3056	3361	3667	3973	4278	4584
6		136	273	409	553	691	829	1106	1382	1859	1935	2212	2488	2766	3042	3318	3595	3871	4148
8		119	239	358	466	583	699	932	1165	1398	1631	1864	2097	2330	2563	2796	3029	3262	3495
10		101	201	302	402	502	603	804	1005	1205	1406	1607	1808	2009	2210	2411	2612	2813	3014
12		87	174	260	354	442	531	707	884	1061	1238	1415	1592	1769	1945	2122	2300	2476	2653
1/4		76	153	229	306	382	458	611	764	917	1070	1222	1375	1528	1681	1833	1986	2139	2292
5/16		62	123	185	245	306	367	489	611	733	856	978	1100	1222	1345	1467	1589	1711	1833
3/8		50	101	151	204	255	305	407	509	611	713	815	917	1019	1120	1222	1324	1426	1528
7/16	1/8	43	87	130	175	219	262	349	437	524	611	698	786	873	960	1048	1135	1222	1310
1/2	—	38	76	115	153	191	229	305	382	458	535	611	688	764	840	917	993	1070	1146
9/16	1/4	34	68	102	137	172	206	274	342	410	478	547	616	683	752	820	888	952	1020
5/8	—	32	64	96	122	153	183	244	306	367	428	489	550	611	672	733	794	856	917
11/16	3/8	28	55	83	111	138	167	222	278	333	389	444	500	556	611	667	722	778	833
3/4	—	25	51	76	102	128	153	203	255	305	357	407	458	509	560	611	662	713	764
7/8	1/2	22	43	65	87	109	131	175	218	262	306	350	392	437	480	524	568	611	655
1	—	19	38	57	76	96	115	153	191	230	268	305	344	382	420	458	497	535	573
1-1/8	3/4	17	34	51	68	84	102	136	170	204	238	272	306	340	373	407	441	475	509
1-1/4	—	15	31	46	61	76	92	122	153	183	214	244	275	305	336	367	397	428	458
1-3/8	1	14	28	42	56	69	83	111	139	167	194	222	250	278	306	333	361	389	417
1-1/2	—	13	25	38	51	63	76	102	127	153	178	204	229	255	280	305	331	356	382
1-5/8		12	23	35	47	59	71	94	118	141	165	188	212	235	259	282	306	329	353
1-3/4		11	22	33	44	55	65	87	109	131	153	175	196	218	240	262	284	306	327
1-7/8		10	20	30	41	51	61	81	102	122	143	163	183	204	224	244	265	285	306
2		9	19	29	38	48	57	76	96	115	134	153	172	191	210	229	248	267	287

TECHNICAL High Speed Steel

Metric Sizes

Tap Size	Surface Feet per Minute (SFM)																	
	5'	10'	15'	20'	25'	30'	40'	50'	60'	70'	80'	90'	100'	110'	120'	130'	140'	150'
M1	490	979	1469	1959	2449	2938	3918	4897	5877	6856	7836	8815	9795	10774	11754	12733	13713	14692
M2	242	484	725	967	1209	1451	1934	2418	2901	3385	3868	4352	4835	5319	5803	6286	6770	7253
M3	162	324	486	647	809	971	1295	1619	1942	2266	2590	2914	3237	3561	3885	4208	4532	4856
M3.5	138	277	415	554	692	830	1107	1384	1661	1938	2214	2491	2768	3045	3322	3599	3875	4152
M4	122	243	365	487	608	730	973	1217	1460	1703	1946	2190	2433	2676	2920	3163	3406	3650
M5	97	194	291	388	485	582	776	970	1163	1357	1551	1745	1939	2133	2327	2521	2715	2905
M6	81	162	243	324	405	486	647	809	971	1133	1295	1457	1619	1781	1942	2104	2266	2428
M7	69	138	208	277	346	415	554	692	830	969	1107	1246	1384	1522	1661	1799	1938	2076
M8	61	121	182	243	303	364	485	606	728	849	970	1091	1213	1334	1455	1577	1698	1819
M10	48	97	145	194	242	291	388	485	582	679	776	873	970	1067	1163	1260	1357	1454
M12	40	81	121	162	202	243	324	405	486	567	647	728	809	890	971	1052	1133	1214
M14	35	69	104	139	173	208	277	347	416	485	555	624	693	763	832	901	971	1040
M16	30	61	91	121	152	182	243	303	364	424	485	546	606	667	728	788	849	910
M18	27	54	81	108	135	162	216	269	323	377	431	485	539	593	647	700	754	808
M20	24	49	73	97	121	146	194	243	291	340	388	437	485	534	582	631	680	728
M22	22	44	66	88	110	132	176	221	265	309	353	397	441	485	529	573	618	662
M24	20	40	61	81	101	121	162	202	243	283	323	364	404	445	485	526	566	606
M27	18	36	54	72	90	108	144	180	216	252	287	323	359	395	431	467	503	539
M30	16	32	49	65	81	97	129	162	194	226	259	291	323	356	388	420	453	485



USCTI Table 302

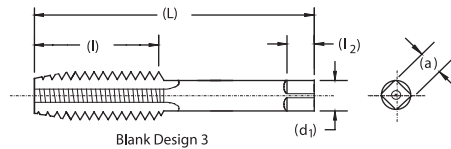
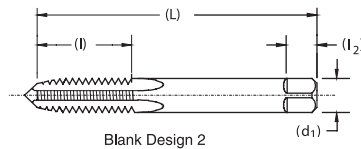
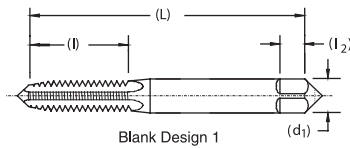

nominal diameter range inches over to (inc.)	machine screw size number inches	nominal fractional diameter inches	nominal metric diameter millimeters (inches)	blank design no.	L overall length	l thread length	l ₂ square length	d ₁ shank diameter	a square size
.052 .065	0 (.0600)		M1.6 (.0630)	1	1.63	.31	.19	.1410	.110
.065 .078	1 (.0730)		M1.8 (.0709)	1	1.69	.38	.19	.1410	.110
.078 .091	2 (.0860)		M2 (0787) M2.2 (.0866)	1	1.75	.44	.19	.1410	.110
.091 .104	3 (.0990)		M2.5 (.0984)	1	1.81	.50	.19	.1410	.110
.104 .117	4 (.1120)			1	1.88	.56	.19	.1410	.110
.117 .130	5 (.1250)		M3 (.1181)	1	1.94	.63	.19	.1410	.110
.130 .145	6 (.1380)		M3.5 (.1378)	1	2.00	.69	.19	.1410	.110
.145 .171	8 (.1640)		M4 (.1575)	1	2.13	.75	.25	.1680	.131
.171 .197	10 (.1900)		M4.5 (.1772) M5 (.1969)	1	2.38	.88	.25	.1940	.152
.197 .223	12 (.2160)			1	2.38	.94	.28	.2200	.165
.223 .260		1/4 (.2500)	M6 (.2362)	2	2.50	1.00	.31	.2550	.191
.260 .323		5/16 (.3125)	M7 (.2756) M8 (.3150)	2	2.72	1.13	.38	.3180	.238
.323 .395		3/8 (.3750)	M10 (.3937)	2	2.94	1.25	.44	.3810	.286
.395 .448		7/16 (.4375)		3	3.16	1.44	.41	.3230	.242
.448 .510		1/2 (.5000)	M12 (.4724)	3	3.38	1.66	.44	.3670	.275
.510 .573		9/16 (.5625)	M14 (.5512)	3	3.59	1.66	.50	.4290	.322
.573 .635		5/8 (.6250)	M16 (.6299)	3	3.81	1.81	.56	.4800	.360
.635 .709		11/16 (.6875)	M18 (.7087)	3	4.03	1.81	.63	.5420	.406
.709 .760		3/4 (.7500)		3	4.25	2.00	.69	.5900	.442
.760 .823		13/16 (.8125)	M20 (.7874)	3	4.47	2.00	.69	.6520	.489
.823 .885		7/8 (.8750)	M22 (.8661)	3	4.69	2.22	.75	.6970	.523
.885 .948		15/16 (.9375)	M24 (.9449)	3	4.91	2.22	.75	.7600	.570
.948 1.010		1 (1.0000)	M25 (.9843)	3	5.13	2.50	.81	.8000	.600
1.010 1.073		1-1/16 (1.0625)	M27 (1.0630)	3	5.13	2.50	.88	.8960	.672
1.073 1.135		1-1/8 (1.1250)		3	5.44	2.56	.88	.8960	.672
1.135 1.198		1-3/16 (1.1875)	M30 (1.1811)	3	5.44	2.56	1.00	1.0210	.766
1.198 1.260		1-1/4 (1.2500)		3	5.75	2.56	1.00	1.0210	.766
1.260 1.323		1-5/16 (1.3125)	M33 (1.2992)	3	5.75	2.56	1.06	1.1080	.831
1.323 1.385		1-3/8 (1.3750)		3	6.06	3.00	1.06	1.1080	.831
1.385 1.448		1-7/16 (1.4375)	M36 (1.4173)	3	6.06	3.00	1.13	1.2330	.925
1.448 1.510		1-1/2 (1.5000)		3	6.38	3.00	1.13	1.2330	.925
1.510 1.635		1-5/8 (1.6250)	M39 (1.5354)	3	6.69	3.19	1.13	1.3050	.979
1.635 1.760		1-3/4 (1.7500)	M42 (1.6535)	3	7.00	3.19	1.25	1.4300	1.072
1.760 1.885		1-7/8 (1.8750)		3	7.31	3.56	1.25	1.5190	1.139
1.885 2.010		2 (2.0000)	M48 (1.8898)	3	7.63	3.56	1.38	1.6440	1.233
2.010 2.135		2 1/8 (2.1250)		3	8.00	3.56	1.38	1.7690	1.327
2.135 2.260		2 1/4 (2.2500)	M56 (2.2047)	3	8.25	3.56	1.44	1.8940	1.420
2.260 2.385		2 3/8 (2.3750)		3	8.50	4.00	1.44	2.0190	1.514
2.385 2.510		2 1/2 (2.5000)		3	8.75	4.00	1.50	2.1000	1.575
2.510 2.635		2 5/8 (2.6250)	M64 (2.5197)	3	8.75	4.00	1.50	2.2250	1.669
2.635 2.760		2 3/4 (2.7500)		3	9.25	4.00	1.56	2.3500	1.762
2.760 2.885		2 7/8 (2.8750)	M72 (2.8346)	3	9.25	4.00	1.56	2.4750	1.856
2.885 3.010		3 (3.0000)		3	9.75	4.56	1.63	2.5430	1.907
3.010 3.135		3 1/8 (3.1250)		3	9.75	4.56	1.63	2.6680	2.001
3.135 3.260		3 1/4 (3.2500)	M80 (3.1496)	3	10.00	4.56	1.75	2.7930	2.095
3.260 3.385		3 3/8 (3.3750)		3	10.00	4.56	1.75	2.8830	2.162
3.385 3.510		3 1/2 (3.5000)		3	10.25	4.94	2.00	3.0080	2.256
3.510 3.635		3 5/8 (3.6250)	M90 (3.5433)	3	10.25	4.94	2.00	3.1330	2.350
3.635 3.760		3 3/4 (3.7500)		3	10.50	5.31	2.13	3.2170	2.413
3.760 3.885		3 7/8 (3.8750)		3	10.50	5.31	2.13	3.3420	2.506
3.885 4.010		4 (4.0000)	M100 (3.9370)	3	10.75	5.31	2.25	3.4670	2.600

TECHNICAL High Speed Steel

Technical Information

Element	Nominal Diameter Range in inches		Direction	Tolerance inches
	Over	To (inc.)		
Length Overall - L	.0520	1.0100	Plus or Minus	.031
	1.0100	4.0100	Plus or Minus	.063
Length of Thread - I	.0520	.2230	Plus or Minus	.047
	.2230	.5100	Plus or Minus	.063
	.5100	1.5100	Plus or Minus	.094
	1.5100	4.0100	Plus or Minus	.125
Length of square - l₂	.0520	1.0100	Plus or Minus	.031
	1.0100	4.0100	Plus or Minus	.063
Diameter of shank - d₁	.0520	.2230	Minus	.0015
	.2230	.6350	Minus	.0015
	.6350	1.0100	Minus	.0020
	1.0100	1.5100	Minus	.0020
	1.5100	2.0100	Minus	.0030
	2.0100	4.0100	Minus	.0030
Size of square - a	.0520	.5100	Minus	.004
	.5100	1.0100	Minus	.006
	1.0100	2.0100	Minus	.008
	2.0100	4.0100	Minus	.010

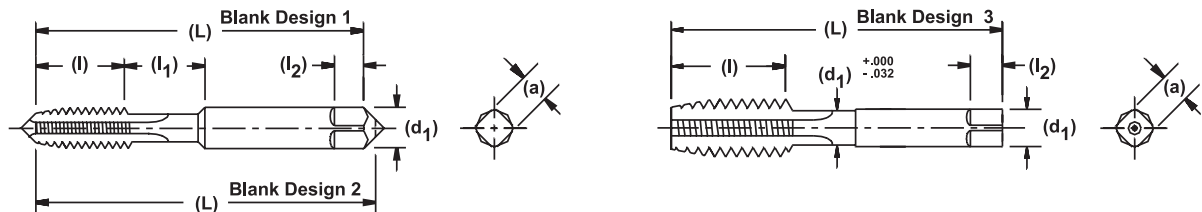
Optional Neck and Shortened Thread Length
USCTI Table 302A

nominal diameter range inches over to (inc.)		machine screw size number inches	nominal fractional diameter inches	nominal metric diameter millimeters (inches)		blank design no.	L overall length	I thread length	l ₁ neck length	l ₂ square length	d ₁ shank diameter	a square size
.104	.117	4 (.1120)				1	1.88	.31	.25	.19	.1410	.110
.117	.130	5 (.1250)		M3	(.1181)	1	1.94	.31	.31	.19	.1410	.110
.130	.145	6 (.1380)		M3.5	(.1378)	1	2.00	.38	.31	.19	.1410	.110
.145	.171	8 (.1640)		M4	(.1575)	1	2.13	.38	.38	.25	.1680	.131
.171	.197	10 (.1900)		M4.5	(.1772)	1	2.38	.50	.38	.25	.1940	.152
				M5	(.1969)							
.197	.223	12 (.2160)				1	2.38	.50	.44	.28	.2200	.165
.223	.260		1/4 (.2500)	M6	(.2362)	2	2.50	.63	.38	.31	.2550	.191
.260	.323		5/16 (.3125)	M7(.2756)	M8(.3150)	2	2.72	.69	.44	.38	.3180	.238
.323	.395		3/8 (.3750)	M10	(.3937)	2	2.94	.75	.50	.44	.3810	.286
.395	.448		7/16 (.4375)			3	3.16	.88	-	.41	.3230	.242
.448	.510		1/2 (.5000)	M12	(.4724)	3	3.38	.94	-	.44	.3670	.275
.510	.573		9/16 (.5625)	M14	(.5541)	3	3.59	1.00	-	.50	.4290	.322
.573	.635		5/8 (.6250)	M16	(.6299)	3	3.81	1.09	-	.56	.4800	.360
.635	.709		11/16 (.6875)	M18	(.7087)	3	4.03	1.09	-	.63	.5420	.406
.709	.760		3/4 (.7500)			3	4.25	1.22	-	.69	.5900	.442
.760	.823		13/16 (.8125)	M20	(.7874)	3	4.47	1.22	-	.69	.6520	.489
.823	.885		7/8 (.8750)	M22	(.8661)	3	4.69	1.34	-	.75	.6970	.523
.885	.948		15/16 (.9375)	M24	(.9449)	3	4.91	1.34	-	.75	.7600	.570
.948	1.010		1 (1.0000)	M25	(.9843)	3	5.13	1.50	-	.81	.8000	.600

TECHNICAL
High Speed Steel

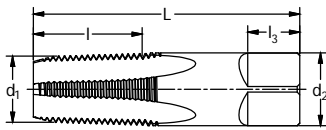

311
Pipe Tap Blank Design 1

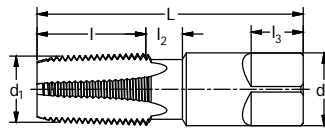

311
Pipe Tap Blank Design 2
with optional neck

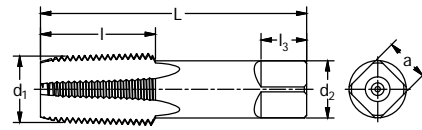

311
Pipe Tap Blank Design 3

General Dimensions (all measurements in inches)

nominal size	tap style	overall length L	thread length l	square length l ₃	shank dia. d ₂	square size a	optional neck l ₂
1/16	1	2.13	.69	.38	.3125	.234	.375
1/8	1	2.13	.75	.38	.3125	.234	-
1/8	1	2.13	.75	.38	.4375	.328	.375
1/4	1	2.44	1.06	.44	.5625	.421	.375
3/8	1	2.56	1.06	.50	.7000	.531	.375
1/2	3	3.13	1.38	.63	.6875	.515	-
3/4	3	3.25	1.38	.69	.9063	.679	-
1	3	3.75	1.75	.81	1.1250	.843	-
1-1/4	3	4.00	1.75	.94	1.3125	.984	-
1-1/2	3	4.25	1.75	1.00	1.5000	1.125	-
2	3	4.50	1.75	1.13	1.8750	1.406	-
2-1/2	3	5.50	2.56	1.25	2.2500	1.687	-
3	3	6.00	2.63	1.38	2.6250	1.968	-
3-1/2	3	6.50	2.69	1.50	2.8125	2.108	-
4	3	6.75	2.75	1.56	3.0000	2.250	-

Tolerances (all measurements in inches)

element	range	direction	tolerance
Length Overall	1/16" to 3/4" inc.	+ / -	.031
- L	1" to 4" inc.	+ / -	.063
Length of Thread	1/16" to 3/4" inc.	+ / -	.063
- l	1" to 1-1/4" inc.	+ / -	.094
	1-1/2" to 4"	+ / -	.125
Length of Square	1/16" to 3/4" inc.	+ / -	.031
- l ₃	1" to 4" inc.	+ / -	.063
Diameter of Shank	1/16" to 1/8"	-	.0015
- d ₂	1/4" to 1" inc.	-	.0020
	1-1/4" to 4" inc.	-	.0030
Size of Square	1/16" to 1/8"	-	.004
- a	1/4" to 3/4" inc.	-	.006
	1" to 4" inc.	-	.008

TECHNICAL High Speed Steel



Technical Information

Ground Thread Unified & American National Form USCTI Table 327 Fractional

Lead Tolerance

A maximum lead error of + / - .0005" in 1" of thread is permitted.

Pitch Diameter Limits

for taps through 1" diameter:

- H1 = basic to basic plus .0005"
- H2 = basic plus .0005" to basic plus .001"
- H3 = basic plus .001" to basic plus .0015"
- H4 = basic plus .0015" to basic plus .002"
- H5 = basic plus .002" to basic plus .0025"
- H6 = basic plus .0025" to basic plus .003"

for Taps over 1" Diameter Through 1-1/2" diameter:

- H4 = basic plus .001" to basic plus .002"

Angle Tolerance

Threads Per Inch Error in Half Angle

- 6 to 9 inclusive 25' + / -
- 10 to 28 inclusive 30' + / -

Formula (Approximate)

- Max. Major Diameter = Basic Major Diameter + A*
- Min. Major Diameter = Max. Major Diameter - B*

*See Table 331.

Thread Limits

nom size	threads per inch			major diameter			basic pitch dia	pitch diameter limits											
	NC UNC	NF UNF	NS UNS	basic	min	max		H1 limit		H2 limit		H3 limit		H4 limit		H5 limit		H6 limit	
								min	max	min	max	min	max	min	max	min	max	min	max
1/4	20	—	—	.2500	.2540	.2550	.2175	.2175	.2180	.2180	.2185	.2185	.2190	—	—	.2195	.2200	—	—
1/4	—	28	—	.2500	.2525	.2535	.2268	.2268	.2273	.2273	.2278	.2278	.2283	.2283	.2288	—	—	—	—
5/16	18	—	—	.3125	.3170	.3180	.2764	.2764	.2769	.2769	.2774	.2774	.2779	—	—	.2784	.2789	—	—
5/16	—	24	—	.3125	.3155	.3165	.2854	.2854	.2859	.2859	.2864	.2864	.2869	.2869	.2874	—	—	—	—
3/8	16	—	—	.3750	.3800	.3810	.3344	.3344	.3349	.3349	.3354	.3354	.3359	—	—	.3364	.3369	—	—
3/8	—	24	—	.3750	.3780	.3790	.3479	.3479	.3484	.3484	.3489	.3489	.3494	.3494	.3499	—	—	—	—
7/16	14	—	—	.4375	.4435	.4445	.3911	—	—	.3916	.3921	.3921	.3926	—	—	.3931	.3936	—	—
7/16	—	20	—	.4375	.4415	.4425	.4050	—	—	—	—	.4060	.4065	—	—	.4070	.4075	—	—
1/2	13	—	—	.5000	.5065	.5075	.4500	.4500	.4505	.4505	.4510	.4510	.4515	—	—	.4520	.4525	—	—
1/2	—	20	—	.5000	.5040	.5050	.4675	.4675	.4680	.4680	.4685	.4685	.4690	—	—	.4695	.4700	—	—
9/16	12	—	—	.5625	.5690	.5700	.5084	—	—	.5089	—	—	.5099	—	—	.5104	.5109	—	—
9/16	—	18	—	.5625	.5670	.5680	.5264	—	—	.5269	.5274	.5274	.5279	—	—	.5284	.5289	—	—
5/8	11	—	—	.6250	.6320	.6330	.5660	—	—	.5665	.5670	.5670	.5675	—	—	.5680	.5685	—	—
5/8	—	18	—	.6250	.6295	.6305	.5889	—	—	.5894	.5899	.5899	.5904	—	—	.5909	.5914	—	—
11/16	—	—	11	.6875	.6945	.6955	.6285	—	—	—	—	.6295	.6300	—	—	—	—	—	—
11/16	—	—	16	.6875	.6925	.6935	.6469	—	—	—	—	.6479	.6484	—	—	—	—	—	—
3/4	10	—	—	.7500	.7575	.7590	—	—	.6855	.6855	.6860	.6860	.6865	—	—	.6870	.6875	—	—
3/4	—	16	—	.7500	.7550	.7560	.7094	.7094	.7099	.7099	.7104	.7104	.7109	—	—	.7114	.7119	—	—
7/8	9	—	—	.8750	.8835	.8850	.8028	—	—	—	—	—	—	.8043	.8048	—	—	.8053	.8058
7/8	—	14	—	.8750	.8810	.8820	.8286	—	—	.8291	.8296	—	—	.8301	.8306	—	—	.8311	.8316
1	8	—	—	1.0000	1.0095	1.0110	.9188	—	—	.9193	.9198	—	—	.9203	.9208	—	—	.9213	.9218
1	—	12	—	1.0000	1.0065	1.0075	.9459	—	—	—	—	—	—	.9474	.9479	—	—	—	—
1	—	—	14	1.0000	1.0060	1.0070	.9536	—	—	—	—	—	—	.9551	.9556	—	—	—	—
1-1/8	7	—	—	1.1250	1.1350	1.1370	1.0322	—	—	—	—	—	—	1.0332	1.0342	—	—	—	—
1-1/8	—	12	—	1.1250	1.132	1.1325	1.0709	—	—	—	—	—	—	1.0719	1.0729	—	—	—	—
1-1/4	7	—	—	1.2500	1.2600	1.2620	1.1572	—	—	—	—	—	—	1.1582	1.1592	—	—	—	—
1-1/4	—	12	—	1.2500	1.2565	1.2575	1.1959	—	—	—	—	—	—	1.1969	1.1979	—	—	—	—
1-3/8	6	—	—	1.3750	1.3870	1.3890	1.2667	—	—	—	—	—	—	1.2677	1.2687	—	—	—	—
1-3/8	—	12	—	1.3750	1.3815	1.3825	1.3209	—	—	—	—	—	—	1.3219	1.3229	—	—	—	—
1-1/2	6	—	—	1.5000	1.5120	1.5140	1.3917	—	—	—	—	—	—	1.3927	1.3937	—	—	—	—
1-1/2	—	12	—	1.5000	1.507	1.5075	1.4459	—	—	—	—	—	—	1.4469	1.4479	—	—	—	—

TECHNICAL High Speed Steel





USCTI Table 329
Machine Screw Taps

Lead Tolerance

A maximum lead error of + / - .0005" in 1" of thread is permitted.

Angle Tolerance

Threads Per Inch Error in Half Angle
20 to 80 inclusive 30' + / -

Pitch Diameter Limits:

- H1 = basic to basic + .0005" to basic + .001"
- H2 = basic + .0005" to basic + .001"
- H3 = basic + .001" to basic + .0015"
- H7 = basic + .003" to basic + .0035"

Formula

Max. Major Diameter = Basic Major Diameter + A
Min. Major Diameter = Max. Major Diameter - B
A = Constant to add: 45% of the theoretical truncation to nearest .0005"
B = Major diameter tolerance.

TECHNICAL
High Speed Steel

Thread Limits

nom size	threads per inch			major diameter			basic pitch dia	pitch diameter limits							
	NC UNC	NF UNF	NS UNS	basic	min	max		H1 limit		H2 limit		H3 limit		H7 limit	
								min	max	min	max	min	max	min	max
0	—	80	—	.0600	.0605	.0615	.0519	.0519	.0524	.0524	.0529	—	—	—	—
1	64	—	—	.0730	.0735	.0745	.0629	.0629	.0634	.0634	.0639	—	—	—	—
1	—	72	—	.0730	.0735	.0745	.0640	.0640	.0645	.0645	.0650	—	—	—	—
2	56	—	—	.0860	.0865	.0875	.0744	.0744	.0749	.0749	.0754	—	—	—	—
2	—	64	—	.0860	.0865	.0875	.0759	—	—	.0764	.0769	—	—	—	—
3	48	—	—	.0990	.1000	.1010	.0855	.0855	.0860	.0860	.0865	—	—	—	—
3	—	56	—	.0990	.0995	.1005	.0874	.0874	.0879	.0879	.0884	—	—	—	—
4	—	—	36	.1120	.1135	.1145	.0940	—	—	.0945	.0950	—	—	—	—
4	40	—	—	.1120	.1135	.1145	.0958	.0958	.0963	.0963	.0968	—	—	—	—
4	—	48	—	.1120	.1130	.1140	.0985	.0985	.0990	.0990	.0995	—	—	—	—
5	40	—	—	.1250	.1265	.1275	.1088	.1088	.1093	.1093	.1098	—	—	—	—
5	—	44	—	.1250	.1260	.1270	.1102	—	—	.1107	.1112	—	—	—	—
6	32	—	—	.1380	.1400	.1410	.1177	.1177	.1182	.1182	.1187	.1187	.1192	.1207	.1212
6	—	40	—	.1380	.1395	.1405	.1218	.1218	.1223	.1223	.1228	—	—	—	—
8	32	—	—	.1640	.1660	.1670	.1437	.1437	.1442	.1442	.1447	.1447	.1452	.1467	.1472
8	—	36	—	.1640	.1655	.1665	.1460	—	—	.1465	.1470	—	—	—	—
10	24	—	—	.1900	.1930	.1940	.1629	.1629	.1634	.1634	.1639	.1639	.1644	.1659	.1664
10	—	32	—	.1900	.1920	.1930	.1697	.1697	.1702	.1702	.1707	.1707	.1712	.1727	.1732
12	24	—	—	.2160	.2190	.2200	.1889	—	—	—	—	.1899	.1904	—	—
12	—	28	—	.2160	.2185	.2195	.1928	—	—	—	—	.1938	.1943	—	—



General

The following tables and formula are used in determining the limits and tolerances for ground thread taps having special diameter or special pitch or both and having a thread lead angle not in excess of 5%, unless otherwise specified. This table does not apply to the diameter and pitch combinations shown in Tables 327 and 329.

Note: When the tap major diameter must be determined from a specific tap pitch diameter, the maximum major diameter = the minimum specified pitch diameter – constant C, + constant A.

Lead Tolerance

A maximum lead error of + / – .0005" in 1" of thread is permitted.

Values for W, X, Y and Z (inches)

threads per inch	A	B	C thru 5/8	C over 5/8" thru 2-1/2"	C over 2-1/2	D thru 1"	D over 1" thru 1-1/2"	D over 1-1/2" thru 2-1/2"	D over 2-1/2"
80	.0015	.0010	.0005	.0010	.0015	.0005	.0010	.0010	.0015
56	.0015	.0010	.0005	.0010	.0015	.0005	.0010	.0010	.0015
48	.0020	.0010	.0005	.0010	.0015	.0005	.0010	.0010	.0015
44	.0020	.0010	.0005	.0010	.0015	.0005	.0010	.0010	.0015
40	.0025	.0010	.0005	.0010	.0015	.0005	.0010	.0010	.0015
36	.0025	.0010	.0005	.0010	.0015	.0005	.0010	.0010	.0015
32	.0030	.0010	.0010	.0010	.0015	.0005	.0010	.0010	.0015
28	.0035	.0010	.0010	.0010	.0015	.0005	.0010	.0010	.0015
24	.0040	.0010	.0010	.0010	.0015	.0005	.0010	.0015	.0015
20	.0050	.0010	.0010	.0010	.0015	.0005	.0010	.0015	.0015
18	.0055	.0010	.0010	.0010	.0015	.0005	.0010	.0015	.0015
16	.0060	.0010	.0010	.0010	.0015	.0005	.0010	.0015	.0020
14	.0070	.0010	.0010	.0015	.0015	.0005	.0010	.0015	.0020
13	.0075	.0010	.0010	.0015	.0015	.0005	.0010	.0015	.0020
12	.0075	.0010	.0010	.0015	.0015	.0005	.0010	.0015	.0020
11	.0080	.0010	.0010	.0015	.0020	.0005	.0010	.0015	.0020
10	.0090	.0015	—	.0015	.0020	.0005	.0010	.0015	.0020
9	.0100	.0015	—	.0015	.0020	.0005	.0010	.0015	.0020
8	.0110	.0015	—	.0015	.0020	.0005	.0010	.0015	.0020
7	.0120	.0020	—	.0015	.0020	.0010	.0010	.0020	.0025
6	.0140	.0020	—	.0015	.0020	.0010	.0010	.0020	.0025
5-1/2	.0160	.0025	—	.0015	.0020	.0010	.0015	.0020	.0025
5	.0160	.0025	—	.0015	.0020	.0010	.0015	.0020	.0025
4-1/2	.0170	.0025	—	.0015	.0020	.0010	.0015	.0020	.0025
4	.0190	.0025	—	.0015	.0020	.0010	.0015	.0020	.0025

For intermediate pitches use value for next coarser pitch.

Angle Tolerance

Threads Per Inch	Error in Half Angle
4 to 5-1/2 inclusive	20' + / –
6 to 9 inclusive	25' + / –
10 to 80 inclusive	30' + / –

Formula

- Max. Major Diameter = Basic Major Diameter + A
- Min. Major Diameter = Max. Major Diameter – B
- Max. Pitch Diameter = Min. Pitch Diameter + D
- Min. Pitch Diameter = Basic Pitch Diameter + C

A = constant to add:

- 35% of the theoretical truncation for 4 to 5 threads per inch
- 40% for 5-1/2 to 12 threads per inch
- 45% for 13 to 80 threads per inch

to nearest .005" for 8 or more threads per inch

B = Major diameter tolerance

C = Amount over basic for minimum pitch diameter

D = Pitch diameter tolerance

Ground Thread

Tap Limits

USCTI Table 341

Metric Taps

Technical Information

General

These tables and formula are used in determining the limits and tolerances for ground thread metric taps unless otherwise specified. They apply only to metric threads having a 60° form with a P/8 flat at the major diameter of the basic thread form.

Note: When the tap major diameter must be determined from a specific tap pitch diameter, the minimum major diameter equals the maximum specified tap pitch diameter minus constant Y, plus the basic size height of thread (.64952P), plus constant W.

Lead Tolerance

A maximum lead error of + / - .0005" in 1" of thread is permitted.

Angle Tolerance

Pitch mm	Deviation in Half Angle
over 0.25 to 2.5 inclusive	30' + / -
over 2.5 to 4 inclusive	25' + / -
over 4 to 6 inclusive	20' + / -

Formula

- Max. Major Diameter = Min. + X
- Min. Major Diameter = Basic + W
- Max. Pitch Diameter = Basic + Y
- Min. Pitch Diameter = Max. - Z
- W = Constant to add to Basic Major Diameter (.080P converted to inches)
- X = Major Diameter Tolerance
- Y = Amount over Basic for Maximum Pitch Diameter
- Z = Pitch Diameter Tolerance

Values for W, X, Y and Z (inches)

pitch mm	inch equivalent	W inch	X inch	Y				Z			
				M1.6 thru M6.3	over M6.3 thru M25	over M25 thru M90	over M90	M1.6 thru M6.3	over M6.3 thru M25	over M25 thru M90	over M90
0.3	.01181	.0009	.0010	.0015	.0015	.0020	.0020	.0006	.0006	.0008	.0008
0.35	.01378	.0011	.0010	.0015	.0015	.0020	.0020	.0006	.0006	.0008	.0008
0.4	.01575	.0013	.0010	.0015	.0020	.0020	.0020	.0006	.0006	.0008	.0010
0.45	.01772	.0014	.0010	.0015	.0020	.0020	.0020	.0006	.0008	.0008	.0010
0.5	.01968	.0016	.0010	.0015	.0020	.0020	.0025	.0006	.0008	.0010	.0010
0.6	.02362	.0019	.0010	.0020	.0020	.0025	.0025	.0008	.0008	.0010	.0010
0.7	.02756	.0022	.0016	.0020	.0020	.0025	.0025	.0008	.0008	.0010	.0010
0.75	.02953	.0024	.0016	.0020	.0025	.0025	.0030	.0008	.0010	.0010	.0012
0.8	.03150	.0025	.0016	.0020	.0025	.0025	.0030	.0008	.0010	.0010	.0012
0.9	.03543	.0028	.0016	.0020	.0025	.0025	.0030	.0008	.0010	.0010	.0012
1	.03937	.0032	.0016	.0025	.0025	.0030	.0030	.0010	.0010	.0012	.0012
1.25	.04921	.0039	.0025	.0025	.0025	.0030	.0035	.0010	.0012	.0012	.0016
1.5	.05906	.0047	.0025	.0025	.0030	.0030	.0035	.0010	.0012	.0012	.0016
1.75	.06890	.0055	.0025	—	.0030	.0035	.0040	—	.0012	.0016	.0016
2	.07874	.0063	.0025	—	.0035	.0035	.0040	—	.0016	.0016	.0016
2.5	.09843	.0079	.0025	—	.0035	.0040	.0045	—	.0016	.0016	.0020
3	.11811	.0095	.0039	—	.0040	.0040	.0050	—	.0016	.0020	.0020
3.5	.13780	.0110	.0039	—	.0040	.0045	.0050	—	.0016	.0020	.0020
4	.15748	.0126	.0039	—	.0040	.0045	.0055	—	.0020	.0020	.0025
4.5	.17717	.0142	.0039	—	—	.0050	.0055	—	.0020	.0020	.0025
5	.19685	.0158	.0039	—	—	.0050	.0060	—	—	.0025	.0025
5.5	.21654	.0158	.0039	—	—	.0050	.0060	—	—	.0025	.0025
6	.23622	.0189	.0039	—	—	.0055	.0060	—	—	.0025	.0025

TECHNICAL High Speed Steel

Thread Dimensions

nominal size & pitch		basic major diameter	basic pitch diameter	basic minor diameter	max minor diameter Class 3B internal thread	nominal size & pitch		basic major diameter	basic pitch diameter	basic minor diameter	max minor diameter Class 3B internal thread
0	80	.0600	.0519	.0438	.0514	6	32	.1380	.1177	.0974	.1140
1	64	.0730	.0629	.0527	.0623	6	36	.1380	.1200	.1019	.1165
1	72	.0730	.0640	.0550	.0635	6	40	.1380	.1218	.1055	.1186
2	56	.0860	.0744	.0628	.0737	8	32	.1640	.1437	.1234	.1389
2	64	.0860	.0759	.0657	.0753	8	36	.1640	.1460	.1279	.1416
3	48	.0990	.0855	.0719	.0845	8	40	.1640	.1478	.1315	.1437
3	56	.0990	.0874	.0758	.0865	10	24	.1900	.1629	.1359	.1516
4	32	.1120	.0917	.0714	.0880	10	28	.1900	.1668	.1436	.1604
4	36	.1120	.0940	.0759	.0919	10	30	.1900	.1684	.1467	.1630
4	40	.1120	.0958	.0795	.0939	10	32	.1900	.1697	.1494	.1641
4	48	.1120	.0985	.0849	.0968	12	24	.2160	.1889	.1619	.1807
5	40	.1250	.1088	.0925	.1062	12	28	.2160	.1928	.1696	.1857
5	44	.1250	.1102	.0955	.1079	12	32	.2160	.1957	.1754	.1895
						14	20	.2420	.2095	.1770	.1987
						14	24	.2420	.2149	.1879	.2059

Constants for Finding Pitch Diameter and Minor Diameter of Screw Threads

Basic Pitch Diameter = Basic Major Diameter – Constant for Basic Pitch Diameter for TPI

Basic Minor Diameter = Basic Major Diameter – Constant for Basic Minor Diameter for TPI

threads per inch	pitch		constant for basic pitch dia.		constant for basic minor dia.		threads per inch	pitch		constant for basic pitch dia.		constant for basic minor dia.	
	in	mm	Unified	ISO	Unified	ISO		in	mm	Unified	ISO	Unified	ISO
-	.0079	0.2	-	.00511	-	.01022	20	.0500	-	.03248	-	.06496	-
-	.0088	0.225	-	.00575	-	.01150	18	.0555	-	.03608	-	.07216	-
-	.0098	0.25	-	.00639	-	.01278	-	.0590	1.5	-	.03836	-	.07672
-	.0118	0.3	-	.00767	-	.01534	16	.0625	-	.04060	-	.08120	-
80	.0125	-	.00812	-	.01624	-	-	.0689	1.75	-	.04475	-	.08950
-	.0138	0.35	-	.00895	-	.01790	14	.0714	-	.04639	-	.09278	-
72	.0139	-	.00902	-	.01804	-	13	.0769	-	.04996	-	.09992	-
64	.0156	-	.01015	-	.02030	-	-	.0787	2.0	-	.05117	-	.10228
-	.0157	0.4	-	.01023	-	.02046	12	.0833	-	.05413	-	.10826	-
-	.0177	0.45	-	.01151	-	.02302	11.5	.0869	-	.05648	-	.11296	-
56	.0178	-	.01160	-	.02320	-	11	.0909	-	.05905	-	.11810	-
-	.0197	0.5	-	.01279	-	.02558	-	.0984	2.5	-	.06393	-	.12786
48	.0208	-	.01353	-	.02706	-	10	.1000	-	.06495	-	.12990	-
44	.0227	-	.01476	-	.02952	-	9	.1111	-	.07217	-	.14434	-
-	.0236	0.6	-	.01534	-	.03068	-	.1181	3.0	-	.07672	-	.15344
40	.0250	-	.01624	-	.03248	-	8	.1250	-	.08119	-	.16238	-
-	.0275	0.7	-	.01790	-	.03580	-	.1378	3.5	-	.08950	-	.17900
36	.0278	-	.01804	-	.03608	-	7	.1428	-	.09279	-	.18558	-
-	.0295	0.75	-	.01918	-	.03836	-	.1575	4.0	-	.10229	-	.20458
32	.0312	-	.02030	-	.04060	-	6	.1667	-	.10825	-	.21650	-
-	.0315	0.8	-	.02046	-	.04092	-	.1772	4.5	-	.11507	-	.23014
28	.0357	-	.02320	-	.04640	-	-	.1968	5.0	-	.12786	-	.25572
27	.0370	-	.02406	-	.04812	-	5	.2000	-	.12990	-	.25980	-
-	.0394	1.0	-	.02557	-	.05114	-	.2165	5.5	-	.14064	-	.28128
24	.0417	-	.02706	-	.05412	-	4.5	.2222	-	.14434	-	.28868	-
-	.0492	1.25	-	.03196	-	.06392	-	.2362	6.0	-	.15343	-	.30353
							4	.2500	-	.16238	-	.32476	-

continued on next page



USCTI Table 352
Fractional Sizes

TECHNICAL
High Speed Steel

nominal size & TPI		basic major diameter	basic pitch diameter	basic minor diameter	max minor diameter Class 3B internal thread	nominal size & TPI		basic major diameter	basic pitch diameter	basic minor diameter	max minor diameter Class 3B internal thread
1/16	64	.0625	.0524	.0422	.0518	13/16	12	.8125	.7584	.7042	.7329
3/32	48	.0938	.0803	.0667	.0793	13/16	16	.8125	.7719	.7313	.7533
1/8	40	.1250	.1088	.0925	.1062	13/16	20	.8125	.7800	.7475	.7662
5/32	32	.1563	.1360	.1157	.1311	7/8	9	.8750	.8028	.7307	.7681
5/32	36	.1563	.1382	.1202	.1339	7/8	12	.8750	.8209	.7668	.7952
3/16	24	.1875	.1604	.1334	.1530	7/8	14	.8750	.8286	.7822	.8068
3/16	32	.1875	.1672	.1469	.1616	7/8	16	.8750	.8344	.7938	.8158
7/32	24	.2188	.1917	.1646	.1834	7/8	18	.8750	.8389	.8028	.8230
7/32	32	.2188	.1985	.1782	.1922	7/8	20	.8750	.8425	.8100	.8287
1/4	20	.2500	.2175	.1850	.2067	15/16	12	.9375	.8834	.8293	.8575
1/4	24	.2500	.2229	.1959	.2139	15/16	16	.9375	.8969	.8563	.8783
1/4	28	.2500	.2268	.2036	.2190	15/16	20	.9375	.9050	.8725	.8912
1/4	32	.2500	.2297	.2094	.2229	1	8	1.0000	.9188	.8376	.8797
5/16	18	.3125	.2764	.2403	.2630	1	12	1.0000	.9459	.8918	.9198
5/16	20	.3125	.2800	.2476	.2680	1	14	1.0000	.9536	.9072	.9315
5/16	24	.3125	.2854	.2584	.2754	1	16	1.0000	.9594	.9188	.9408
5/16	32	.3125	.2922	.2719	.2847	1	20	1.0000	.9675	.9350	.9537
3/8	16	.3750	.3344	.2938	.3182	1-1/16	12	1.0625	1.0084	.9543	.9823
3/8	20	.3750	.3425	.3100	.3297	1-1/16	16	1.0625	1.0219	.9813	1.0033
3/8	24	.3750	.3479	.3209	.3372	1-1/16	18	1.0625	1.0264	.9903	1.0105
3/8	32	.3750	.3547	.3344	.3469	1-1/8	7	1.1250	1.0322	.9394	.9875
7/16	14	.4375	.3911	.3447	.3717	1-1/8	8	1.1250	1.0438	.9626	1.0047
7/16	20	.4375	.4050	.3726	.3916	1-1/8	12	1.1250	1.0709	1.0168	1.0448
7/16	24	.4375	.4104	.3834	.3994	1-1/8	16	1.1250	1.0844	1.0438	1.0658
7/16	28	.4375	.4143	.3911	.4051	1-1/8	18	1.1250	1.0889	1.0528	1.0730
1/2	12	.5000	.4459	.3918	.4223	1-3/16	12	1.1875	1.1334	1.0793	1.1073
1/2	13	.5000	.4500	.4001	.4284	1-3/16	16	1.1875	1.1469	1.1063	1.1283
1/2	20	.5000	.4675	.4351	.4537	1-3/16	18	1.1875	1.1514	1.1153	1.1355
1/2	24	.5000	.4729	.4459	.4619	1-1/4	7	1.2500	1.1572	1.0644	1.1125
1/2	28	.5000	.4768	.4536	.4676	1-1/4	8	1.2500	1.1688	1.0876	1.1297
9/16	12	.5625	.5084	.4542	.4843	1-1/4	12	1.2500	1.1959	1.1418	1.1698
9/16	18	.5625	.5264	.4903	.5106	1-1/4	16	1.2500	1.2094	1.1688	1.1908
9/16	24	.5625	.5354	.5084	.5244	1-1/4	18	1.2500	1.2139	1.1778	1.1980
5/8	11	.6250	.5660	.5069	.5391	1-5/16	12	1.3125	1.2584	1.2043	1.2323
5/8	12	.6250	.5709	.5168	.5463	1-5/16	16	1.3125	1.2719	1.2313	1.2533
5/8	18	.6250	.5889	.5528	.5730	1-5/16	18	1.3125	1.2764	1.2403	1.2605
5/8	24	.6250	.5979	.5709	.5869	1-3/8	6	1.3750	1.2667	1.1585	1.2146
11/16	11	.6875	.6285	.5694	.6012	1-3/8	8	1.3750	1.2938	1.2126	1.2547
11/16	12	.6875	.6334	.5793	.6085	1-3/8	12	1.3750	1.3209	1.2668	1.2948
11/16	16	.6875	.6469	.6063	.6284	1-3/8	16	1.3750	1.3344	1.2938	1.3158
11/16	24	.6875	.6604	.6334	.6494	1-3/8	18	1.3750	1.3389	1.3028	1.3230
3/4	10	.7500	.6850	.6201	.6545	1-7/16	12	1.4375	1.3834	1.3293	1.3573
3/4	12	.7500	.6959	.6418	.6707	1-7/16	16	1.4375	1.3969	1.3563	1.3783
3/4	16	.7500	.7094	.6688	.6908	1-7/16	18	1.4375	1.4014	1.3653	1.3855
3/4	20	.7500	.7175	.6850	.7037						

Technical Information
Basic Thread Dimensions (cont'd)
USCTI Table 352
Fractional Sizes

nominal size & TPI		basic major diameter	basic pitch diameter	basic minor diameter	max minor diameter Class 3B internal thread	nominal size & TPI		basic major diameter	basic pitch diameter	basic minor diameter	max minor diameter Class 3B internal thread
1-1/2	6	1.5000	1.3917	1.2835	1.3396	2-5/8	12	2.6250	2.5709	2.5168	2.5448
1-1/2	8	1.5000	1.4188	1.3376	1.3797	2-5/8	16	2.6250	2.5844	2.5438	2.5658
1-1/2	12	1.5000	1.4459	1.3918	1.4198	2-3/4	4	2.7500	2.5876	2.4252	2.5094
1-1/2	16	1.5000	1.4594	1.4188	1.4408	2-3/4	8	2.7500	2.6688	2.5876	2.6297
1-1/2	18	1.5000	1.4639	1.4278	1.4480	2-3/4	12	2.7500	2.6959	2.6418	2.6698
1-1/2	16	1.5625	1.5219	1.4813	1.5033	2-3/4	16	2.7500	2.7094	2.6688	2.6908
1-1/2	18	1.5625	1.5264	1.4903	1.5105	2-7/8	12	2.8750	2.8209	2.7668	2.7948
1-5/8	6	1.6250	1.5167	1.4085	1.4646	2-7/8	16	2.8750	2.8344	2.7938	2.8158
1-5/8	8	1.6250	1.5438	1.4626	1.5047	3	4	3.0000	2.8376	2.6752	2.7594
1-5/8	12	1.6250	1.5709	1.5168	1.5448	3	8	3.0000	2.9188	2.8376	2.8797
1-5/8	16	1.6250	1.5844	1.5438	1.5658	3	12	3.0000	2.9459	2.8918	2.9198
1-5/8	18	1.6250	1.5889	1.5528	1.5730	3	16	3.0000	2.9594	2.9188	2.9408
1-11/16	16	1.6875	1.6469	1.6063	1.6283	3-1/8	12	3.1250	3.0709	3.0168	3.0448
1-11/16	18	1.6875	1.6514	1.6153	1.6355	3-1/8	16	3.1250	3.0844	3.0438	3.0658
1-3/4	5	1.7500	1.6201	1.4902	1.5575	3-1/4	4	3.2500	3.0876	2.9252	3.0094
1-3/4	8	1.7500	1.6688	1.5876	1.6297	3-1/4	8	3.2500	3.1688	3.0876	3.1297
1-3/4	12	1.7500	1.6959	1.6418	1.6698	3-1/4	12	3.2500	3.1959	3.1418	3.1698
1-3/4	16	1.7500	1.7094	1.6688	1.6908	3-1/4	16	3.2500	3.2094	3.1688	3.1908
1-13/16	16	1.8125	1.7719	1.7313	1.7533	3-3/8	12	3.3750	3.3209	3.2668	3.2948
1-7/8	8	1.8750	1.7938	1.7126	1.7547	3-3/8	16	3.3750	3.3344	3.2938	3.3158
1-7/8	12	1.8750	1.8209	1.7668	1.7948	3-3/8	4	3.5000	3.3376	3.1752	3.2594
1-7/8	16	1.8750	1.8344	1.7938	1.8158	3-1/2	8	3.5000	3.4188	3.3376	3.3797
1-15/16	16	1.9375	1.8969	1.8563	1.8783	3-1/2	12	3.5000	3.4459	3.3918	3.4198
2	4-1/2	2.0000	1.8557	1.7113	1.7861	3-1/2	16	3.5000	3.4594	3.4188	3.4408
2	8	2.0000	1.9188	1.8376	1.8797	3-5/8	12	3.6250	3.5709	3.5168	3.5448
2	12	2.0000	1.9459	1.8918	1.9198	3-5/8	16	3.6250	3.5844	3.5438	3.5658
2	16	2.0000	1.9594	1.9188	1.9408	3-3/4	4	3.7500	3.5876	3.4252	3.5094
2-1/16	16	2.0625	2.0219	1.9813	2.0033	3-3/4	8	3.7500	3.6688	3.5876	3.6297
2-1/8	8	2.1250	2.0438	1.9626	2.0047	3-3/4	12	3.7500	3.6959	3.6418	3.6698
2-1/8	12	2.1250	2.0709	2.0168	2.0448	3-3/4	16	3.8750	3.7094	3.6686	3.6908
2-1/8	16	2.1250	2.0844	2.0438	2.0658	3-7/8	12	3.8750	3.8209	3.7669	3.7948
2-3/16	16	2.1875	2.1469	2.1063	2.1283	3-7/8	16	3.8750	3.8344	3.7938	3.8158
2-1/4	4-1/2	2.2500	2.1057	1.9613	2.0361	4	4	4.0000	3.8376	3.6752	3.7594
2-1/4	8	2.2500	2.1688	2.0876	2.1297	4	8	4.0000	3.9188	3.8376	3.8797
2-1/4	12	2.2500	2.1959	2.1418	2.1698	4	12	4.0000	3.9459	3.8918	3.9198
2-1/4	16	2.2500	2.2094	2.1688	2.1908	4	16	4.0000	3.9594	3.9188	3.9408
2-5/16	16	2.3125	2.2719	2.2313	2.2533	4	16	1.8125	1.7719	1.7313	1.7533
2-3/8	12	2.3750	2.3209	2.2668	2.2948						
2-3/8	16	2.3750	2.3344	2.2938	2.3158						
2-7/16	16	2.4375	2.3969	2.3563	2.3783						
2-1/2	4	2.5000	2.3376	2.1752	2.2594						
2-1/2	8	2.5000	2.4188	2.3376	2.3797						
2-1/2	12	2.5000	2.4459	2.3918	2.4198						
2-1/2	16	2.5000	2.4594	2.4188	2.4408						

TECHNICAL
High Speed Steel

Thread Mill Information

Features

- Helical flute design reduces thread chatter, improving product thread finish and quality
- Advanced TiAlN coating is standard for increasing speeds
- Ideal for internal and external threads
- Full range of sizes available
 - Internal threads #4 to 1" UNC and UNF
 - Pipe threads 1/16" to 1" NPT, NPTF and NPSM
 - Metric internal threads M4.5 x .75 through M20 x 3
- Specials program for nonstandard sizes and other coatings

Applications

- Cleveland thread mills are the ideal choice when:
- Machine tool has helical interpolation capabilities
 - Thread specification calls for full threads close to bottom of hole
 - Thread specification requires a special tap
 - Small lot size is to be threaded
 - Need to cut large diameter threads on low horsepower machines
 - Workpiece is thin walled which can be milled more easily than tapped
 - CNC machine has a slower RPM capability below what is recommended for carbide thread mills

Benefits

- Thread milling is a superior process for threading most materials
- More economical than using taps:
 - One thread mill can produce several diameters of threaded holes of the same pitch
 - Same tool makes right or left-hand threads
 - Avoid chip packing in blind holes, a primary cause of tap breakage
 - One tool for through and blind holes
 - Pitch diameter can be controlled by CNC offset

Calculating Thread Mill Feed Rate

For internal threads: $(D1 - d1) / D1 \times \text{RPM} \times \text{ipr}$

For external threads: $(D1 + d1) / D1 \times \text{RPM} \times \text{ipr}$

where:

D1 is the major diameter of the thread

d1 is the cutting diameter

RPM is the calculated speed rate = $(3.82 \times \text{SFM}) / \text{Diameter}$

ipr is the calculated feed rate = $\text{IPT (inches per tooth)} \times \text{number of flutes per cutter}$

Example: to cut an internal 7/8-14 thread using a four-flute, 1/2" diameter cutter in bronze, the programmed feed rate would be $((.875 - .500) / .875) \times (3438 \text{ RPM} \times .016)$ or 23.6 ipm

Operating Parameters for Helical Thread Mills

material	surface feet per minute (SFM)	cutter diameter (inches)					
		0.125	0.250	0.375	0.500	0.750	1.000
		feed per tooth (inches)					
Al-Si Alloys	600	0.0010	0.0020	0.0030	0.0040	0.0050	0.0060
cast iron	600	0.0008	0.0015	0.0020	0.0030	0.0040	0.0050
brass or bronze	450	0.0010	0.0020	0.0030	0.0040	0.0050	0.0060
steel <200 Bhn	600	0.0007	0.0015	0.0020	0.0030	0.0040	0.0050
steel <325 Bhn	575	0.0005	0.0010	0.0015	0.0020	0.0030	0.0040
stainless steel	525	0.0005	0.0008	0.0015	0.0020	0.0030	0.0040
tool steels, annealed	125	0.0005	0.0008	0.0012	0.0015	0.0020	0.0030

TECHNICAL High Speed Steel

Tech Tip

How to request Made-to-Order taps:

Information required for every order:

- quantity
- ordering number

Information required for some tool styles:

- exact tool size
- threads per inch
- pitch
- thread form
- right- or left-hand
- limit
- pitch diameter
- class of fit
- chamfer
- number of chamfered threads
- chamfer angle
- number of lube grooves
- short projections

Made To Order Taps Available

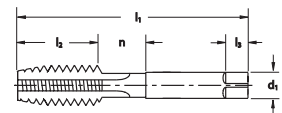

Other features available:

- surface treatment
- special hook
- male centers removed
- special back tape
- recessed neck
- shank flats
- special shank diameter
- special rake
- thread relief
- interrupted threads
- controlled root
- ETTCO notch
- shank grooves



Ground Thread Tap Limits

All standard ground thread taps made to USCTI Tables 327 and 329 will be marked **G** to designate ground thread. **G** will be followed by **H** to designate above basic or **L** for below basic and a numeral to designate the pitch diameter limits. For example: **G H3** indicates a ground thread tap with pitch diameter limits .0010" to .0015" over basic. See table at right.

For taps over 1-1/2" diameter with H or L limit numbers, divide the the H or L limit number by 2 to get the amount (in thousandths of an inch) the maximum tap pitch diameter is over basic for the H series or under basic for the L series. In H series taps, the tolerance shown in USCTI Table 331, Column D, **subtracted** from the maximum pitch diameter will give the minimum pitch diameter. In L series taps the tolerance shown in Table 331, Column D, **added** to the minimum pitch diameter will give the maximum pitch diameter. These taps will be marked with the appropriate H or L limit number.



The Proper Use of Lubricants in Tapping

Applying the proper lubricants in tapping operations can result in longer tap life, increased production, better workpiece size control, smoother and more accurate threads, less resharping, and more efficient chip removal. Generally, for best tap performance, straight cutting oil should be used. For non-ferrous and non-metallic materials, a coolant or a cutting fluid (light oil or soluble oil) is recommended.

Often, machining centers are equipped with a coolant or a cutting fluid that contains enough water and oil to provide adequate cooling and lubrication for a variety of tools and workpieces. However, most soluble blends are not suitable for tapping applications. Tapping, especially with thread-forming taps, requires more lubrication than cooling. A coolant or cutting fluid might lack the lubrication necessary to obtain acceptable tool life and part finish. Get recommendations from a coolant specialist.

After you select the proper lubricant, choose the right method of application and pressure. For tapping, use multiple nozzles around the tap. Nozzles should be as close to the surface of the part as possible, positioned at an angle close to the axis of the tool, and should point directly into the hole to flush chips from the flutes. For horizontal tapping, where the tap is stationary and the workpieces rotate, consider using two streams of lubricant, one on each side of the tap.

Whether you are tapping vertically, horizontally, or at an angle, make sure the lubricant reaches the cutting lands of the tap at all times, especially at the point or chamfered sections. Brushing or squirting oil or fluid onto the tap does not provide sufficient lubrication. In fact, heavy viscosity oil may cause the chips to stick or cling to a tap, increasing the chance of breakage. In addition,

if the lubricant is automatically applied only on the forward motion of the tap, time the application of the lubricant so that it will reach the hole before the tap starts to cut, particularly with machines on which the cutting fluid is automatically shut off when the tap reverses. For maximum effectiveness, it is better to force the lubricant into the hole under pressure, which will vary depending on the tapping method, hole depth, and tapping speed.

Keep tapping lubricants as clean as possible using a filtering system or other equipment. Dust and other foreign particles can contaminate oil and decrease its effectiveness. Thoroughly clean machines and oil tanks when adding new lubricant and at regular intervals to ensure optimum results.

Pitch Diameter Limits

for taps through 1" diameter

L1 =	basic to basic - .0005
H1 =	basic to basic + .0005
H2 =	basic + .0005 to basic + .0010
H3 =	basic + .0010 to basic + .0015
H4 =	basic + .0015 to basic + .0020
H5 =	basic + .0020 to basic + .0025
H6 =	basic + .0025 to basic + .0030

for taps over 1" diameter through 1-1/2" diameter

H4 =	basic + .0010 to basic + .0020
------	--------------------------------

Special Taps

Call for a Quote



Call Customer Service at 800.348.2885 for your quote

Prices for special taps are available upon request. Special taps can be furnished in quantities to meet your specific requirements. All special metric taps will produce internal threads which conform to ISO, ISO modified, and the obsolete OMFS thread systems and are manufactured to USCTI standard blank dimensions to fit the tap holders and machine spindles now in use in the USA.



FAST TAP
 Common Special Taps and Special Taps from Blanks

Important Update: All products in this catalog are Center Cutting (CC) End Mills.

In the past Greenfield has sold HSS End Mills in two brands, Cleveland and Putnam. In late 2016, most items sold in the Putnam Catalog were moved into the Cleveland Catalog, and the Putnam Brand will no longer be sold as a separate brand. A move was also made to manufacture all end mills as Center Cutting. However, Non-Center Cutting (NCC) End Mills, especially in the Putnam Brand, may still be available, while quantities last. Please inquire on purchasing if the product you are buying is available as a NCC End Mill. If the item you desire is not in this catalog, please inquire of our capability to make your item as a special.



Carbide End Mills

Our carbide end mills were included in our 2017 Cleveland™ Catalog. Our end mills are designed to machine a broad range of materials and are manufactured out of premium grade carbide material.

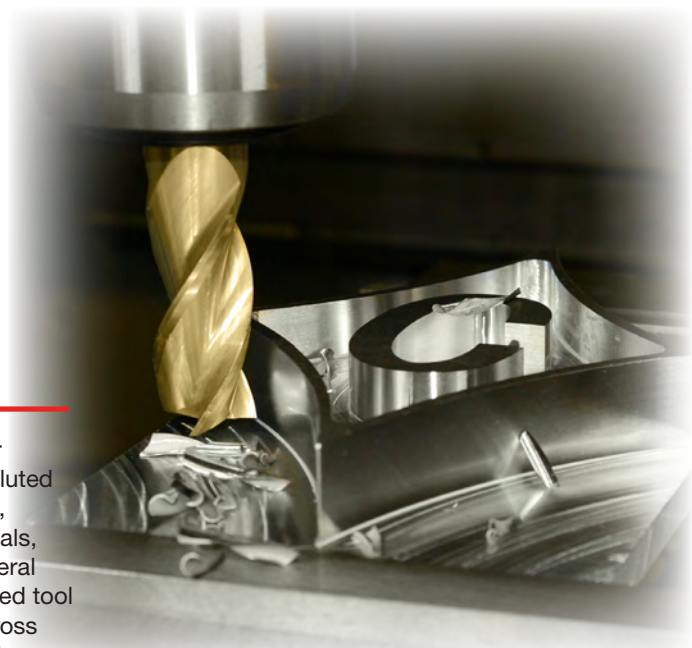

TECH TIP

Flute Selection: The selection of a tool with the proper number of flutes for any round tool is important. A two fluted tool will always have the greatest amount of chip space, and therefore should be the tool of choice in soft materials, or in situations where the tool will be run more than several diameters of itself deep. On the other hand, the two fluted tool will usually be the weaker tool because of the thinner cross section of web. Tools with more flutes (3,4,6,8, etc) will have a stronger backbone because those flutes are more shallow and provide much more cutting action. This will lead one to use a tool with more than two flutes in harder, tougher materials, or where stronger tools and less chip space are required.

TECH TIP

Understanding Chip Load per Tooth/Tool

1. Every material has an appropriate amount of stock that can be removed in milling. This rate of removal is defined as feed or chip load.
2. Chip load per tooth (CLT) is the selected maximum depth of cut for material removed by one cutting edge in one revolution of the tool.
3. This amount can vary per material, size of the end mill or number of flutes. Softer materials afford higher CLT compared to harder, tougher materials. Larger diameter tools afford higher CLT also.
4. Greenfield Industries' catalogs have charts to help determine chip load per tooth starting points. See the Speed & Feed data in the technical section.
5. Chip Load per Tool is simply the CLT per tooth X the number of cutting faces contained on the end mill. Increasing the number of cutting edges also increases inches per minute/production rate.

Here are a couple of examples: 1/4 diameter, 2 flute end mill in aluminum CLT is .0005 to .002 @200-600 SFM, 3056-9168 RPM Using .002 CLT x 2 flutes = .004 chip load per tool @6,000 RPM =24 Inches per minute
1/4 diameter, change to a 3 flute tool .002 CLT x 3 flutes = .006 chip load per tool @6,000 RPM = 36 Inches per minute.



End Mill Product Index226-229

High Speed Steel, Cobalt, and Carbide

- | | |
|-----------------|----------------|
| Miniature | Left Hand Cut |
| General Purpose | Variable Index |
| Finishers | Engraving Tool |
| Roughers | Chamfer Tool |
| Left Hand Helix | |



Technical Information

Nomenclature 324

End Mill Finishes and Their Applications 326

Speeds and Feeds 327

Operating Parameters, HSS and Cobalt 329

Operating Parameters, PM Plus™, HSS & Cobalt 331

End Mill Selection and Use 332

Carbide

 Operating Parameters, Variable Index

 Style CEM-V-4 (R and B), CEM-V2-5R 333

 Style CEM-HPDE-5, CEM-EMS (-3 and -5) 334

 Style CEM-AM (2 and 3) 335

 Style CEM-R (S and A) 336

 Style CEM-V3-7R 336

Cutting Data 338

Regrinding End Mills 339

TECH TIPS

Flute Selection 224

Understanding Chip Load per Tooth/Tool 224

Using Drill Mills. 251

Benefits of Multi Flute End Mill. 255, 277

Using Style HG-4LL End Mill 258

Miniature End Mill Features 261

PM Plus™ High-Performance

 End Mills Deliver Superior Performance. 275

 The PM-539 Advantage 281

 Reducing Vibration & Chatter. 326

Surface Treatment







Additional treatments available upon request.













High Speed Steel

High Speed Steel				End Work		Application					Machining				Surface Treatment									
Type	Style	Page	No. of Flutes	Square	Ball	Chamfer	Radius/Rounding	Steel	Stainless	Cast Iron	Non-Ferrous	High-Temp Alloy	Hardened Steel	Slot	Profile	Plunging	Ramping	Drilling	Chamfer	Slot w/ Radius	Bright	TiN	TiCN	TiAlN
	Miniature	HMD-2	230	2	•			•	•	•				•	•	•	•				•			•
	Miniature	HMD-2B	231	2		•		•	•	•				•	•	•	•			•	•			
	Miniature	HMD-4	232	4	•			•	•	•					•		•				•			
	Miniature	HMG-2	233	2	•			•	•	•				•	•	•	•				•			
	Miniature	HMG-2B	234	2		•		•	•	•				•	•	•	•			•	•			
	Miniature	HMG-4	235	4	•			•	•	•					•		•				•			
	Finisher	HD-2	236	2	•			•	•	•				•	•	•	•				•	•	•	
	Finisher	HD-2B	238	2		•		•	•	•				•	•	•	•			•	•	•		
	Finisher	HD-3	239	3	•			•	•	•				•	•	•	•				•	•	•	
	Finisher	HD-4C	240	4	•			•	•	•					•		•				•	•	•	
	Finisher	HG-2	241	2	•			•	•	•				•	•	•	•				•	•	•	
	Finisher	HG-2M	244	2	•			•	•	•				•	•	•	•				•			
	Finisher	HG-2B	245	2		•		•	•	•				•	•	•	•				•	•	•	
	Keyway	HG-2K	246	2	•			•	•	•				•	•	•	•				•	•	•	
	Keyway Cutter	HG-2KS	247	2	•			•	•	•				•							•			
	Finisher - Extended Neck	HGN-2	248	2	•			•	•	•				•	•	•	•				•			
	Finisher - Extended Neck	HGN-2B	249	2		•		•	•	•				•	•	•	•				•			
	Finisher - High Helix	HGA-2	250	2	•			•	•	•				•	•	•	•				•	•	•	
	Finisher - Drill Mill	HPDM-2	251	2			<i>Pointed end</i>	•	•	•				•	•		•				•	•	•	
	General Purpose	HG-3	252	3	•			•	•	•				•	•	•					•	•	•	

High Speed Steel (continued)				No. of Flutes	End Work			Application					Machining				Surface Treatment							
Type	Style	Page			Square	Ball	Chamfer	Radius/Rounding	Steel	Stainless	Cast Iron	Non-Ferrous	High-Temp Alloy	Hardened Steel	Slot	Profile	Plunging	Ramping	Drilling	Chamfer	Slot w/ Radius	Bright	TiN	TiCN
	General Purpose	HG-4C	252	M	•			•	•	•					•		•				•	•	•	
	General Purpose	HG-4MC	256	4	•			•	•	•					•		•				•	•	•	
	General Purpose	HG-4B	257	4		•		•	•	•					•		•				•	•	•	
	Left Hand Helix / Cut	HG-4LL	258	4	•			•	•	•					•		•				•	•	•	
	Corner Radius	CRE	259	4			•	•	•	•					•						•	•	•	

M = Multi Flute

Cobalt				No. of Flutes	End Work			Application					Machining				Surface Treatment							
Type	Style	Page			Square	Ball	Chamfer	Radius	Steel	Stainless	Cast Iron	Non-Ferrous	High-Temp Alloy	Hardened Steel	Slot	Profile	Plunging	Ramping	Drilling	Chamfer	Slot w/ Radius	Bright	TiN	TiCN
	Miniature End Mill	HMDC-2	260	2	•			•	•	•				•	•	•	•				•	•	•	
	Miniature End Mill	HMDC-4	261	4	•			•	•	•					•		•				•	•	•	
	Finisher	HDC-2	262	2	•			•	•	•				•	•	•	•				•	•	•	
	Finisher	HDC-4C	263	4	•			•	•	•					•		•				•	•	•	
	Finisher	HGC-2	264	2	•			•	•	•				•	•	•	•				•	•	•	
	Finisher	HGC-2B	266	2		•		•	•	•				•	•	•	•				•	•	•	
	Finisher	HGC-4C	267	M	•			•	•	•					•		•				•	•	•	
	Finisher	HGC-4B	269	M		•		•	•	•					•		•				•	•	•	
	Rougher Fine Pitch	RG6	270	M	•			•	•	•				•	•	•	•				•	•	•	
	Rougher Coarse Pitch	RG8	271	M			•	•	•	•					•		•				•	•	•	
	Rougher - Extra Coarse Pitch	RG9	273	3			•	•	•	•					•		•				•	•	•	

M = Multi Flute

Powdered Metal

				End Work				Application					Machining				Surface Treatment								
Image	Type	Style	Page	No. of Flutes	Square	Ball	Chamfer	Radius	Steel	Stainless	Cast Iron	Non-Ferrous	High-Temp Alloy	Hardened Steel	Slot	Profile	Plunging	Ramping	Drilling	Chamfer	Slot w/ Radius	Bright	TiN	TiCN	TiAlN
						Finisher	PM-4DE	274	4	•				•	•	•	•	•		•		•			
	Finisher	PM-2	275	2	•				•	•	•	•	•		•	•	•	•				•	•	•	•
	Finisher	PM-3	276	3	•				•	•	•	•	•		•	•		•				•	•	•	•
	Finisher	PM-4	277	M	•				•	•	•	•	•		•	•		•				•	•	•	•
	Finisher	PM-4B	279	4		•			•	•	•	•	•		•	•		•				•	•	•	•
	Finisher High Helix	PM-539R	280	3	•		•		•	•	•	•	•		•	•		•			•	•	•	•	•
	Finisher - Left - High Helix/Cut	PM-539L	281	3	•				•	•	•	•	•		•	•		•				•	•	•	•
	Rougher Coarse Profile	PMRC-C	282	M	•				•	•	•	•	•		•	•		•				•	•	•	•
	Rougher Fine Profile	PMRF-C	283	M	•				•	•	•	•	•		•	•		•	•	•		•	•	•	•
	Rougher Coarse Profile	PM-538R	284	3	•			•	•	•	•	•	•		•	•		•			•	•	•	•	•
	Rougher - Left Low Helix/Cut	PM-538L	285	3	•		•		•	•	•	•	•		•	•		•			•	•	•	•	•

M = Multi Flute

Carbide













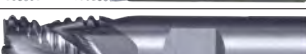
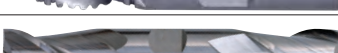

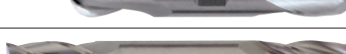
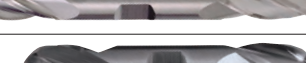
Tolerances for Solid Carbide End Mills

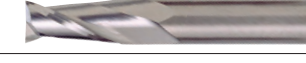
Cutting Diameter: 1/32" through 1": +0.000 - 0.002

Shank Diameter: h6

				End Work				Application					Machining				Surface Treatment									
Image	Type	Style	Page	No. of Flutes	Square	Ball	Chamfer	Radius	Steel	Stainless	Cast Iron	Non-Ferrous	High-Temp Alloy	Hardened Steel	Slot	Profile	Plunging	Ramping	Drilling	Chamfer	Slot w/ Radius	Bright	TiCN	TiAlN	AlCrN	Zn
						Variable Index Ferrous Material	CEM-V-4R	286	4	•			•	•	•	•	•	•		•	•	•	•			•
	Variable Index Ferrous Material	CEM-V-4B	289	4		•		•	•	•	•	•	•		•	•	•	•			•	•	•	•	•	
	Variable Index Ferrous Material	CEM-V2-5R	290	5	•			•	•	•	•	•	•		•	•	•	•			•	•	•	•	•	
	Steel Material	CEM-V3-7R CEM-V3-7RCB	292	7				•	•	•	•	•	•		•	•	•	•			•	•	•	•	•	
	Steel Material	CEM-HPDE-5	295	5	•			•	•	•	•	•	•		•	•		•			•	•	•	•	•	
	Steel Material	CEM-EMS-3	296	3	•			•	•	•	•	•	•		•	•	•	•			•	•	•	•	•	
	Steel Material	CEM-EMS-5	297	5	•			•	•	•	•	•	•		•	•	•	•			•	•	•	•	•	

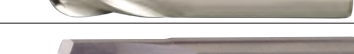
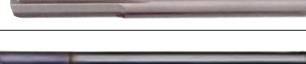
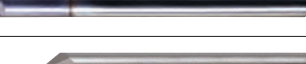
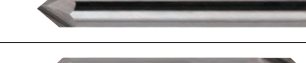
Carbide (continued)

				End Work			Application					Machining					Surface Treatment						
				No. of Flutes	Square Ball	Chamfer Radius	Steel	Stainless	Cast Iron	Non-Ferrous	High-Temp Alloy	Hardened Steel	Slot	Profile	Plunging	Ramping	Drilling	Chamfer	Slot w/ Radius	Bright	TiCN	TiAlN	AlCrN
Type	Style	Page																					
	Aluminum Material	CEM-AM2	298	2	•																		
	Aluminum Material	CEM-AM3	299	3	•																		
	Rougher	CEM-RS	301	4	•					•													
	Rougher	CEM-RA	302	3	•					•													
	General Purpose	CEM-DE2	303	2	•					•	•	•											
	General Purpose	CEM-DE2B	304	2		•				•	•	•											
	General Purpose	CEM-DE4	305	4	•					•	•	•											
	General Purpose	CEM-DE4B	306	4		•				•	•	•											
	Miniature	CMCE-2 CMCE-2AL	307	2	•					•	•	•	•										
	General Purpose	CEM-SE2	309	2	•		•			•	•	•											
	General Purpose	CEM-SE2B	311	2		•				•	•	•											
	General Purpose	CEM-SE3	313	3	•		•			•	•	•											
	Miniature	CMCE-4 CMCE-4AL	314	4	•					•	•	•	•										
	General Purpose	CEM-SE4	316	4	•		•			•	•	•											
	General Purpose	CEM-SE4B	319	4		•				•	•	•											
	Straight Flute	CEM-SEST2	321	2						•	•	•											
	Engraving Tool	CEM-EG2	321	2		•				•	•	•											
	Chamfer Tool	CEM-CH2	322	2			•			•	•	•											
	Chamfer Tool	CEM-CH2D	322	2			•			•	•	•											
	Chamfer Tool	CEM-CH4	323	4			•			•	•	•											
	Chamfer Tool	CEM-CH4D	323	4			•			•	•	•											

M = Multi Flute

HSS

ANSI SIZES

2 Flute CC

Helix 30°

Square End

Surface Treatment

Bright

TiCN

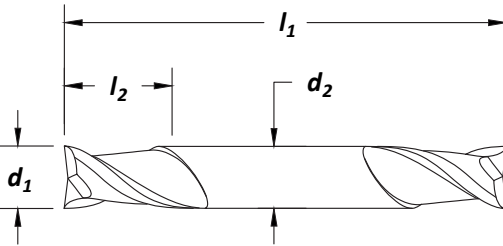

High Speed Steel

Center Cutting

cutting diameter d_1	decimal equiv.	shank dia d_2 (in)	length of cut l_2 (in)	overall length l_1 (in)	no. of flutes	order number	
						Bright	TiCN
1/32	.0312	.188	.047	2.000	2	C41001	C39851
1/32	.0312	.188	.094	2.250	2	C41032	C39883
3/64	.0469	.188	.063	2.000	2	C41003	C39852
3/64	.0469	.188	.141	2.250	2	C41034	C39884
1/16	.0625	.188	.094	2.000	2	C41005	C39853
1/16	.0625	.188	.188	2.250	2	C41036	C39885
1/16	.0625	.188	.219	2.500	2	C41070	C39909
5/64	.0781	.188	.125	2.000	2	C41006	C39854
5/64	.0781	.188	.234	2.250	2	C41037	C39886
3/32	.0938	.188	.141	2.000	2	C41008	C39855
3/32	.0938	.188	.281	2.250	2	C41039	C39887
3/32	.0938	.188	.281	2.625	2	C41072	C39910
7/64	.1094	.188	.156	2.000	2	C41010	C39856
7/64	.1094	.188	.328	2.250	2	C41041	C39888
1/8	.1250	.188	.188	2.000	2	C41012	C39857
1/8	.1250	.188	.375	2.250	2	C41043	C39889
1/8	.1250	.188	.750	3.125	2	C41075	C39911
9/64	.1406	.188	.219	2.000	2	C41013	C39858
9/64	.1406	.188	.406	2.250	2	C41044	-
5/32	.1562	.188	.234	2.000	2	C41014	-
5/32	.1562	.188	.438	2.250	2	C41045	C39891
5/32	.1562	.188	.875	3.250	2	C41076	C39912
11/64	.1719	.188	.250	2.000	2	C41016	C39860
11/64	.1719	.188	.500	2.250	2	C41047	C39892
3/16	.1875	.188	.281	2.000	2	C41017	C39861
3/16	.1875	.188	.500	2.250	2	C41048	C39893

Material Reference	Steel (HRc)				Stainless Steel			Cast Iron (HRc)		Aluminum and Non-Ferrous	Hi-Temp Alloy		Hardened Steel (HRc)
	Low Carbon		Alloy		Austenitic	Martensitic	PH	Gray	Nodular		Ni, Co, Fe Based Super Alloy	Titanium	
	Hardness	13-38	>38	16-38	> 38	300 Series	400 series		18-22	22-32			>45
Bright	◆		◆					◆		◆			
TiCN	☆		☆					☆		☆			

☆ = Best Performance ◆ = Acceptable

Style: HMD-2B - Double End
Miniature
HSS
ANSI SIZES

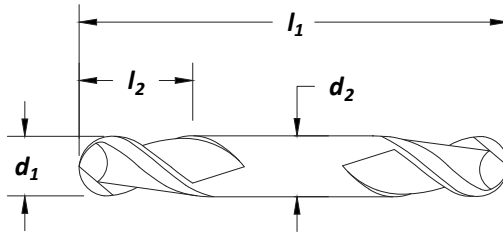
Surface Treatment
Bright

cutting diameter d₁	decimal equiv.	shank dia d₂ (in)	length of cut l₂ (in)	overall length l₁ (in)	no. of flutes	order number HMD-2B Bright
1/32	.0313	.188	.047	2.000	2	C75323
1/32	.0313	.188	.094	2.250	2	C75324
1/16	.0625	.188	.094	2.000	2	C41021
1/16	.0625	.188	.188	2.250	2	C41053
1/16	.0625	.188	.218	2.500	2	C75325
3/32	.0938	.188	.141	2.000	2	C41023
3/32	.0938	.188	.281	2.250	2	C41056
1/8	.1250	.188	.188	2.000	2	C41026
1/8	.1250	.188	.375	2.250	2	C41060
1/8	.1250	.188	.750	3.125	2	C75326
5/32	.1562	.188	.438	2.250	2	C41061
3/16	.1875	.188	.281	2.000	2	C41029
3/16	.1875	.188	.500	2.250	2	C41063
3/16	.1875	.188	1.00	3.375	2	C75327

High Speed Steel
Center Cutting

Material Reference	Steel (HRC)		Stainless Steel			Cast Iron (HRC)		Aluminum and Non-Ferrous	Hi-Temp Alloy		Hardened Steel (HRC)
	Low Carbon	Alloy	Austenitic	Martensitic	PH	Gray	Nodular		Ni, Co, Fe Based Super Alloy	Titanium	
Hardness	13-38	>38	16-38	> 38	300 Series	400 series	18-22	22-32			>45
Bright	☆		☆				☆		☆		

☆ = Best Performance ◆ = Acceptable



Surface Treatment

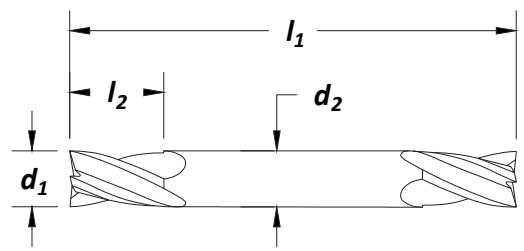

cutting diameter d_1	decimal equiv.	shank dia d_2 (in)	length of cut l_2 (in)	overall length l_1 (in)	no. of flutes	order number HMD-4 Bright
1/16	.0625	.188	.094	2.000	4	C41085
1/16	.0625	.188	.188	2.250	4	C41099
1/16	.0625	.188	.219	2.500	4	C41113
3/32	.0938	.188	.141	2.000	4	C41087
3/32	.0938	.188	.281	2.250	4	C41101
3/32	.0938	.188	.281	2.625	4	C41115
1/8	.1250	.188	.188	2.000	4	C41090
1/8	.1250	.188	.375	2.250	4	C41104
1/8	.1250	.188	.750	3.125	4	C41118
5/32	.1562	.188	.234	2.000	4	C41091
5/32	.1562	.188	.438	2.250	4	C41105
5/32	.1562	.188	.875	3.250	4	C41119
3/16	.1875	.188	.281	2.000	4	C41093
3/16	.1875	.188	.500	2.250	4	C41107
3/16	.1875	.188	1.000	3.375	4	C75328

High Speed Steel

Center Cutting

Material Reference	Steel (HRC)				Stainless Steel			Cast Iron (HRC)		Aluminum and Non-Ferrous	Hi-Temp Alloy		Hardened Steel (HRC)
	Low Carbon		Alloy		Austenitic	Martensitic	PH	Gray	Nodular		Ni, Co, Fe Based Super Alloy	Titanium	
Hardness	13-38	>38	16-38	> 38	300 Series	400 series		18-22	22-32				>45
Bright	☆		☆					☆		☆			

☆ = Best Performance ◆ = Acceptable



Style: HMG-2 - Single End

Miniature

HSS
ANSI SIZES
2 Flute CC
Helix 30°
Square End

Surface Treatment

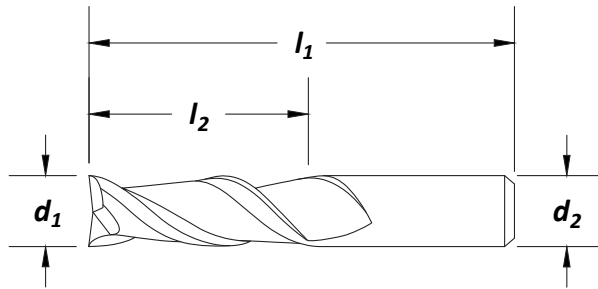

cutting diameter d_1	decimal equiv.	shank dia d_2 (in)	length of cut l_2 (in)	overall length l_1 (in)	no. of flutes	order number HMG-2 Bright
1/32	.0312	.188	.094	1.500	2	C40843
3/64	.0469	.188	.062	1.500	2	C75329
3/64	.0469	.188	.141	1.500	2	C40844
1/16	.0625	.188	.094	1.500	2	C75330
1/16	.0625	.188	.188	1.500	2	C40845
5/64	.0781	.188	.234	1.500	2	C40846
3/32	.0938	.188	.281	1.500	2	C40847
7/64	.1094	.188	.328	1.500	2	C40848
1/8	.1250	.188	.375	1.500	2	C40849
9/64	.1406	.188	.250	1.500	2	C75332
9/64	.1406	.188	.406	1.500	2	C40850
5/32	.1562	.188	.250	1.500	2	C75333
5/32	.1562	.188	.438	1.500	2	C40851
11/64	.1719	.188	.500	1.500	2	C40852
3/16	.1875	.188	.281	1.500	2	C75334
3/16	.1875	.188	.500	1.500	2	C40853

High Speed Steel

Center Cutting

Material Reference	Steel (HRC)		Stainless Steel			Cast Iron (HRC)		Aluminum and Non-Ferrous	Hi-Temp Alloy		Hardened Steel (HRC)
	Low Carbon	Alloy	Austenitic	Martensitic	PH	Gray	Nodular		Ni, Co, Fe Based Super Alloy	Titanium	
Hardness	13-38	>38	16-38	> 38	300 Series	400 series	18-22	22-32			>45
Bright	☆		◆				◆				

☆ = Best Performance ◆ = Acceptable



HSS

ANSI
SIZES



Surface
Treatment

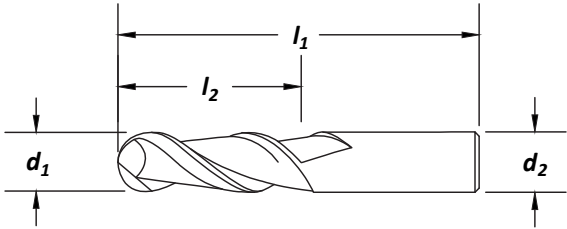

cutting diameter d_1	decimal equiv.	shank dia d_2 (in)	length of cut l_2 (in)	overall length l_1 (in)	no. of flutes	order number HMG-2B Bright
1/32	.0312	.188	.094	1.500	2	C75335
1/16	.0625	.188	.094	1.500	2	C75336
1/16	.0625	.188	.188	1.500	2	C75337
3/32	.0938	.188	.141	1.500	2	C75338
3/32	.0938	.188	.281	1.500	2	C75339
1/8	.1250	.188	.188	1.500	2	C75340
1/8	.1250	.188	.375	1.500	2	C75341
5/32	.1562	.188	.438	1.500	2	C75342
3/16	.1875	.188	.563	1.500	2	C75343

High Speed Steel

Center Cutting

Material Reference	Steel (HRc)				Stainless Steel			Cast Iron (HRc)		Aluminum and Non-Ferrous	Hi-Temp Alloy		Hardened Steel (HRc)
	Low Carbon		Alloy		Austenitic	Martensitic	PH	Gray	Nodular		Ni, Co, Fe Based Super Alloy	Titanium	
Hardness	13-38	>38	16-38	> 38	300 Series	400 series		18-22	22-32				>45
Bright	☆		◆										

☆ = Best Performance ◆ = Acceptable



Style: HMG-4 - Single End

Miniature

HSS

ANSI SIZES



Surface Treatment

Bright

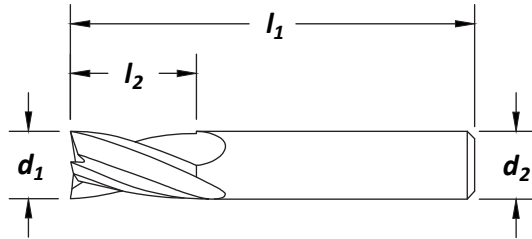

cutting diameter d_1	decimal equiv.	shank dia d_2 (in)	length of cut l_2 (in)	overall length l_1 (in)	no. of flutes	order number HMG-4 Bright
1/16	.0625	.188	.188	1.500	4	C40876
5/64	.0781	.188	.234	1.500	4	C40877
3/32	.0938	.188	.281	1.500	4	C40878
7/64	.1094	.188	.328	1.500	4	C40879
1/8	.1250	.188	.375	1.500	4	C40880
9/64	.1406	.188	.406	1.500	4	C40881
5/32	.1562	.188	.438	1.500	4	C40882
11/64	.1719	.188	.500	1.500	4	C40883
3/16	.1875	.188	.500	1.500	4	C40884

High Speed Steel

Center Cutting

Material Reference	Steel (HRc)				Stainless Steel			Cast Iron (HRc)		Aluminum and Non-Ferrous	Hi-Temp Alloy		Hardened Steel (HRc)
	Low Carbon		Alloy		Austenitic	Martensitic	PH	Gray	Nodular		Ni, Co, Fe Based Super Alloy	Titanium	
	13-38	>38	16-38	> 38	300 Series	400 series		18-22	22-32			>45	
Bright	☆		◆					◆					

☆ = Best Performance ◆ = Acceptable



HSS
ANSI SIZES
2 Flute CC
Helix 30°
Square End
Surface Treatment
Bright
TiN
TiCN

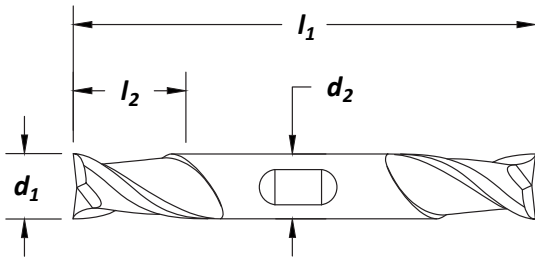

High Speed Steel

Center Cutting

cutting diameter d_1	decimal equiv.	shank dia d_2 (in)	length of cut l_2 (in)	overall length l_1 (in)	no. of flutes	order number		
						Bright	HD-2 TiN	TiCN
1/8	.1250	.375	.188	2.750	2	C42096	C39044	C39049
1/8	.1250	.375	.375	3.063	2	C42051	C33648	C33689
9/64	.1406	.375	.438	3.125	2	C33626	C33649	C33690
5/32	.1562	.375	.234	2.750	2	C42097	C39045	C39050
5/32	.1562	.375	.438	3.125	2	C42052	C33650	C33691
11/64	.1719	.375	.438	3.250	2	C33627	C33651	C33692
3/16	.1875	.375	.281	2.750	2	C42099	C39046	C39051
3/16	.1875	.375	.438	3.250	2	C42054	C33652	C33693
13/64	.2031	.375	.500	3.250	2	C42055	C33653	C33694
7/32	.2188	.375	.328	2.875	2	C42101	C39047	C39052
7/32	.2188	.375	.500	3.250	2	C42056	C33654	C33695
15/64	.2344	.375	.500	3.375	2	C33629	C33655	C33696
1/4	.2500	.375	.375	2.875	2	C42103	C39048	C39053
1/4	.2500	.375	.500	3.375	2	C42058	C33656	C33697
17/64	.2656	.375	.563	3.375	2	C33630	C33657	C33698
9/32	.2812	.375	.563	3.375	2	C42060	C33658	C33699
19/64	.2969	.375	.563	3.500	2	C33631	C33659	C33700
5/16	.3125	.375	.563	3.500	2	C42061	C33660	C33701
21/64	.3281	.375	.563	3.500	2	C33632	C33661	C33702
11/32	.3438	.375	.563	3.500	2	C42063	C33662	C33703
23/64	.3594	.375	.563	3.500	2	C33633	C33663	C33704
3/8	.3750	.375	.563	3.500	2	C42065	C33664	C33705
25/64	.3906	.500	.813	4.125	2	C33634	C33665	C33706
13/32	.4062	.500	.813	4.125	2	C42067	C33666	C33707
27/64	.4219	.500	.813	4.125	2	C33635	C33667	C33708
7/16	.4375	.500	.813	4.125	2	C42069	C33668	C33709
15/32	.4688	.500	.813	4.125	2	C42070	C33670	C33711
31/64	.4844	.500	.813	4.125	2	C33637	C33671	C33712
1/2	.5000	.500	.813	4.125	2	C42072	C33672	C33713
17/32	.5312	.625	1.125	5.000	2	C33638	C33673	C33714
9/16	.5625	.625	1.125	5.000	2	C42074	C33674	C33715

continued on next page

Style: HD-2 - Double End (continued)
Finisher

diameter	decimal equiv.	shank dia d ₂ (in)	length of cut l ₂ (in)	overall length l ₁ (in)	no. of flutes	order number		
						Bright	HD-2 TiN	TiCN
19/32	.5938	.625	1.125	5.000	2	C33639	C33675	C33716
5/8	.6250	.625	1.125	5.000	2	C42076	C33676	C33717
21/32	.6562	.750	1.313	5.625	2	C33640	C33677	C33718
11/16	.6875	.750	1.313	5.625	2	C42078	C33678	C33719
23/32	.7188	.750	1.313	5.625	2	C33641	C33679	C33720
3/4	.7500	.750	1.313	5.625	2	C42080	C33680	C33721
13/16	.8125	.875	1.563	6.125	2	C33643	C33682	C33723
7/8	.8750	.875	1.563	6.125	2	C42084	C33684	C33725
15/16	.9375	1.000	1.625	6.375	2	C33646	C33686	C33727
1	1.0000	1.000	1.625	6.375	2	C42088	C33688	C33729

High Speed Steel
Center Cutting

Material Reference	Steel (HRC)				Stainless Steel			Cast Iron (HRC)		Aluminum and Non-Ferrous	Hi-Temp Alloy		Hardened Steel (HRC)
	Low Carbon		Alloy		Austenitic	Martensitic	PH	Gray	Nodular		Ni, Co, Fe Based Super Alloy	Titanium	
	13-38	>38	16-38	> 38	300 Series	400 series		18-22	22-32	>45			
Hardness													
TiN	◆		◆					◆					
TiCN	☆		☆					☆		◆			

☆ = Best Performance ◆ = Acceptable



Surface Treatment

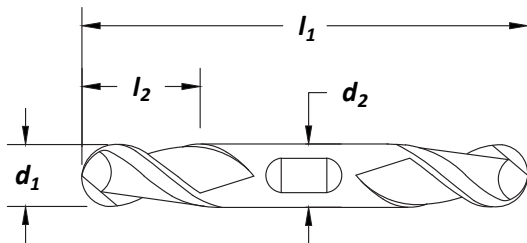

High Speed Steel

Center Cutting

cutting diameter d₁	decimal equiv.	shank dia d₂ (in)	length of cut l₂ (in)	overall length l₁ (in)	no. of flutes	order number		
						Bright	HD-2B TiN	TiCN
1/8	.1250	.375	.1875	3.125	2	C75117	C75120	C75123
1/8	.1250	.375	.375	3.063	2	C42184	C39142	C39158
5/32	.1562	.375	.438	3.125	2	C39136	C39143	C39159
3/16	.1875	.375	.281	3.250	2	C75118	C75121	C75124
3/16	.1875	.375	.438	3.250	2	C42186	C39144	C39160
7/32	.2188	.375	.500	3.250	2	C39137	C39145	C39161
1/4	.2500	.375	.375	3.375	2	C75119	C75122	C75125
1/4	.2500	.375	.500	3.375	2	C42189	C39146	C39162
9/32	.2812	.375	.563	3.375	2	C39138	C39147	C39163
5/16	.3125	.375	.563	3.500	2	C42191	C39148	C39164
11/32	.3438	.375	.563	3.500	2	C39139	C39149	C39165
3/8	.3750	.375	.563	3.500	2	C42194	C39150	C39166
13/32	.4062	.500	.813	4.125	2	C39140	C39151	C39167
7/16	.4375	.500	.813	4.125	2	C42197	C39152	C39168
1/2	.5000	.500	.813	4.125	2	C42199	C39153	C39169
5/8	.6250	.625	1.125	5.000	2	C42202	C39154	C39170
3/4	.7500	.750	1.313	5.625	2	C42205	C39155	C39171
7/8	.8750	.875	1.563	6.125	2	C39141	C39156	C39172
1	1.0000	1.000	1.625	6.375	2	C42212	C39157	C39173

Material Reference	Steel (HRC)				Stainless Steel			Cast Iron (HRC)		Aluminum and Non-Ferrous	Hi-Temp Alloy		Hardened Steel (HRC)
	Low Carbon		Alloy		Austenitic	Martensitic	PH	Gray	Nodular		Ni, Co, Fe Based Super Alloy	Titanium	
	Hardness	13-38	>38	16-38	>38	300 Series	400 series		18-22	22-32			>45
TiN	◆		◆					◆					
TiCN	☆		☆					☆		◆			

☆ = Best Performance ◆ = Acceptable



Style: HD-3 - Double End

Finisher

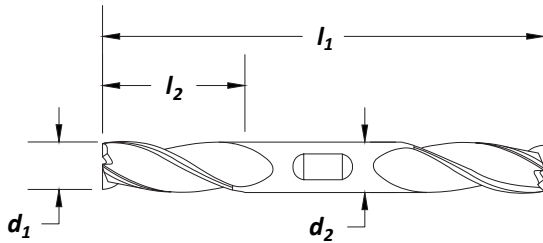

cutting diameter d_1	decimal equiv.	shank dia d_2 (in)	length of cut l_2 (in)	overall length l_1 (in)	no. of flutes	order number		
						Bright	HD-3 TiN	TiCN
1/8	.1250	.375	.375	3.063	3	C39575	C39596	C39617
5/32	.1562	.375	.438	3.125	3	C39576	C39597	C39618
3/16	.1875	.375	.500	3.250	3	C39577	C39598	C39619
7/32	.2188	.375	.563	3.250	3	C39578	C39599	C39620
1/4	.2500	.375	.625	3.375	3	C39579	C39600	C39621
9/32	.2812	.375	.688	3.375	3	C39580	C39601	C39622
5/16	.3125	.375	.750	3.500	3	C39581	C39602	C39623
11/32	.3438	.375	.750	3.500	3	C39582	C39603	C39624
3/8	.3750	.375	.750	3.500	3	C39583	C39604	C39625
13/32	.4062	.500	1.000	4.125	3	C39584	C39605	C39626
7/16	.4375	.500	1.000	4.125	3	C39585	C39606	C39627
1/2	.5000	.500	1.000	4.125	3	C39587	C39608	C39629
9/16	.5625	.625	1.375	5.000	3	C39588	C39609	C39630
5/8	.6250	.625	1.375	5.000	3	C39589	C39610	C39631
3/4	.7500	.750	1.625	5.625	3	C39591	C39612	C39633
7/8	.8750	.875	1.875	6.125	3	C39593	C39614	C39635
1	1.0000	1.000	1.875	6.375	3	C39595	C39616	C39637

High Speed Steel

Center Cutting

Material Reference	Steel (HRc)				Stainless Steel			Cast Iron (HRc)		Aluminum and Non-Ferrous	Hi-Temp Alloy		Hardened Steel (HRc)
	Low Carbon		Alloy		Austenitic	Martensitic	PH	Gray	Nodular		Ni, Co, Fe Based Super Alloy	Titanium	
	Hardness	13-38	>38	16-38	> 38	300 Series	400 series		18-22	22-32			>45
TiN	★		★					★					
TiCN	☆		☆					☆		★			

☆ = Best Performance ★ = Acceptable



HSS

ANSI SIZES

4 Flute CC

Helix 30°

Square End

Surface Treatment

Bright

TiN

TiCN

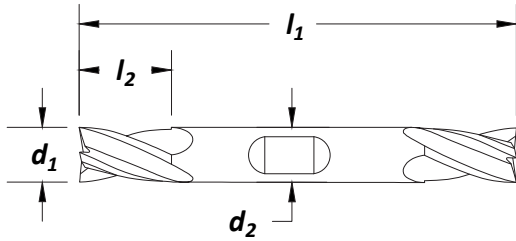

Center Cutting High Speed Steel

cutting diameter	decimal	shank dia	length of cut	overall length	no. of flutes	order number		
						HD-4C		
d_1	equiv.	d_2 (in)	l_2 (in)	l_1 (in)		Bright	TiN	TiCN
1/8	.1250	.375	.188	2.750	4	C74995	C75000	C75005
1/8	.1250	.375	.375	3.063	4	C41202	C33059	C33100
9/64	.1406	.375	.438	3.125	4	C33028	C33060	C33101
5/32	.1562	.375	.234	2.750	4	C74996	C75001	C75006
5/32	.1562	.375	.438	3.125	4	C33029	C33061	C33102
11/64	.1719	.375	.500	3.250	4	C33030	C33062	C33103
3/16	.1875	.375	.281	2.750	4	C74997	C75002	C75007
3/16	.1875	.375	.500	3.250	4	C41204	C33063	C33104
13/64	.2031	.375	.563	3.250	4	C33031	C33064	C33105
7/32	.2188	.375	.328	2.875	4	C74998	C75003	C75008
7/32	.2188	.375	.563	3.250	4	C33032	C33065	C33106
15/64	.2344	.375	.625	3.375	4	C33033	C33066	C33107
1/4	.2500	.375	.375	2.875	4	C74999	C75004	C75009
1/4	.2500	.375	.625	3.375	4	C41207	C33067	C33108
17/64	.2656	.375	.688	3.375	4	C33034	C33068	C33109
9/32	.2812	.375	.688	3.375	4	C33035	C33069	C33110
19/64	.2969	.375	.750	3.500	4	C33036	C33070	C33111
5/16	.3125	.375	.750	3.500	4	C41209	C33071	C33112
21/64	.3281	.375	.750	3.500	4	C33037	C33072	C33113
11/32	.3438	.375	.750	3.500	4	C33038	C33073	C33114
23/64	.3594	.375	.750	3.500	4	C33039	C33074	C33115
3/8	.3750	.375	.750	3.500	4	C41212	C33075	C33116
25/64	.3906	.500	1.000	4.125	4	C33040	C33076	C33117
13/32	.4062	.500	1.000	4.125	4	C33041	C33077	C33118
27/64	.4219	.500	1.000	4.125	4	C33042	C33078	C33119
7/16	.4375	.500	1.000	4.125	4	C33043	C33079	C33120
29/64	.4531	.500	1.000	4.125	4	C33044	C33080	C33121
15/32	.4688	.500	1.000	4.125	4	C33045	C33081	C33122
31/64	.4844	.500	1.000	4.125	4	C33046	C33082	C33123
1/2	.5000	.500	1.000	4.125	4	C41216	C33083	C33124
17/32	.5312	.625	1.375	5.000	4	C33047	C33084	C33125
9/16	.5625	.625	1.375	5.000	4	C33048	C33085	C33126
19/32	.5938	.625	1.375	5.000	4	C33049	C33086	C33127
5/8	.6250	.625	1.375	5.000	4	C41219	C33087	C33128
11/16	.6875	.750	1.625	5.625	4	C33051	C33089	C33130
3/4	.7500	.750	1.625	5.625	4	C41223	C33091	C33132
13/16	.8125	.875	1.875	6.125	4	C33054	C33093	C33134
7/8	.8750	.875	1.875	6.125	4	C41227	C33095	C33136
15/16	.9375	1.000	1.875	6.375	4	C33057	C33097	C75010
1	1.0000	1.000	1.875	6.375	4	C41231	C33099	C33140

Material Reference	Steel (HRC)				Stainless Steel			Cast Iron (HRC)		Aluminum and Non-Ferrous	Hi-Temp Alloy		Hardened Steel (HRC)
	Low Carbon		Alloy		Austenitic	Martensitic	PH	Gray	Nodular		Ni, Co, Fe Based Super Alloy	Titanium	
	Hardness	13-38	>38	16-38	> 38	300 Series	400 series		18-22	22-32			>45
TiN	◆		◆					◆					
TiCN	☆		☆					☆		◆			

☆ = Best Performance ◆ = Acceptable



Style: HG-2 - Single End

Finisher

ANSI SIZES

HSS



Surface Treatment

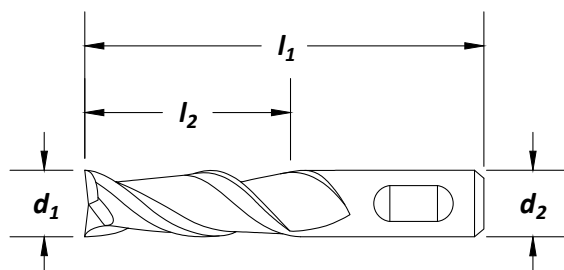

cutting diameter d_1	decimal equiv.	shank dia d_2 (in)	length of cut l_2 (in)	overall length l_1 (in)	no. of flutes	order number		
						Bright	TiN	TiCN
1/8	.1250	.375	.375	2.313	2	C41602	C41550	C33803
5/32	.1562	.375	.438	2.375	2	C33730	C33754	C33804
11/64	.1719	.375	.438	2.375	2	C33731	C33755	C33805
3/16	.1875	.375	.281	2.188	2	C75183	C75217	C75251
3/16	.1875	.375	.438	2.375	2	C41604	C41551	C33806
3/16	.1875	.375	1.250	3.063	2	C39064	C39078	C39107
13/64	.2031	.375	.500	2.438	2	C33732	C33756	C33807
7/32	.2188	.375	.500	2.438	2	C33733	C33757	C33808
7/32	.2188	.375	1.250	3.063	2	C39065	C39079	C39108
15/64	.2344	.375	.500	2.438	2	C33734	C33758	C33809
1/4	.2500	.375	.500	2.438	2	C41607	C41552	C33810
1/4	.2500	.375	1.250	3.063	2	C39066	C39080	C39109
17/64	.2656	.375	.563	2.500	2	C33735	C33759	C33811
9/32	.2812	.375	.563	2.500	2	C33736	C33760	C33812
9/32	.2812	.375	1.375	3.125	2	C39067	C39081	C39110
19/64	.2969	.375	.563	2.500	2	C33737	C33761	C33813
5/16	.3125	.375	.563	2.500	2	C41609	C41553	C33814
5/16	.3125	.375	1.375	3.125	2	C39068	C39082	C39111
21/64	.3281	.375	.563	2.500	2	C33738	C33762	C33815
11/32	.3438	.375	.563	2.500	2	C33739	C33763	C33816
11/32	.3438	.375	1.500	3.250	2	C39069	C39083	C39112
23/64	.3594	.375	.563	2.500	2	C33740	C33764	C33817
3/8	.3750	.375	.563	2.500	2	C41612	C41554	C33818
3/8	.3750	.375	1.000	2.750	2	C75184	C75218	C75252
3/8	.3750	.375	1.500	3.250	2	C41714	C39084	C39113
25/64	.3906	.375	.813	2.688	2	C33741	C33765	C33819
13/32	.4062	.375	.813	2.688	2	C33742	C33766	C33820
13/32	.4062	.500	1.750	3.750	2	C39070	C39085	C39114
27/64	.4219	.375	.813	2.688	2	C33743	C33767	C33821
7/16	.4375	.375	.813	2.688	2	C41615	C33768	C33822
7/16	.4375	.500	1.750	3.750	2	C39071	C39086	C39115
29/64	.4531	.375	.813	2.688	2	C75185	C75219	C75253
29/64	.4531	.500	.813	3.250	2	C33744	C33769	C33823

continued on next page

Material Reference	Steel (HRC)				Stainless Steel			Cast Iron (HRC)		Aluminum and Non-Ferrous	Hi-Temp Alloy		Hardened Steel (HRC)
	Low Carbon		Alloy		Austenitic	Martensitic	PH	Gray	Nodular		Ni, Co, Fe Based Super Alloy	Titanium	
	Hardness	13-38	>38	16-38	> 38	300 Series	400 series		18-22	22-32			>45
TiN	✦		✦					✦					
TiCN	✦		✦					✦		✦			

✦ = Best Performance ✦ = Acceptable



cutting diameter d ₁	decimal equiv.	shank dia d ₂ (in)	length of cut l ₂ (in)	overall length l ₁ (in)	no. of flutes	order number		
						Bright	HG-2 TiN	TiCN
15/32	.4688	.375	.813	2.688	2	C75186	C75220	C75254
15/32	.4688	.500	.813	3.250	2	C33745	C33770	C33824
15/32	.4688	.500	2.000	4.000	2	C39072	C39087	C39116
31/64	.4844	.375	.813	2.688	2	C75187	C75221	C75255
31/64	.4844	.500	.813	3.250	2	C33746	C33771	C33825
1/2	.5000	.375	.813	2.688	2	C41617	C33772	C33826
1/2	.5000	.500	1.000	3.250	2	C41618	C41555	C33827
1/2	.5000	.500	1.500	3.500	2	C75188	C75222	C75256
1/2	.5000	.500	2.000	4.000	2	C41718	C39088	C39117
33/64	.5156	.500	1.000	3.250	2	C75189	C75223	C75257
33/64	.5156	.500	1.125	3.375	2	C33747	C33773	C33828
17/32	.5312	.500	1.125	3.375	2	C33748	C33774	C33829
17/32	.5312	.625	2.000	4.125	2	C39073	C39089	C39118
35/64	.5469	.500	1.125	3.375	2	C33749	C33775	C33830
9/16	.5625	.500	1.125	3.375	2	C41620	C33776	C33831
9/16	.5625	.625	2.000	4.125	2	C39074	C39090	C39119
37/64	.5781	.500	1.125	3.375	2	C33750	C33777	C33832
19/32	.5938	.500	1.125	3.375	2	C33751	C33778	C33833
39/64	.6094	.500	1.125	3.375	2	C33752	C33779	C33834
5/8	.6250	.500	.625	2.750	2	C75190	C75224	C75258
5/8	.6250	.500	1.125	3.375	2	C41622	C33780	C33835
5/8	.6250	.625	1.313	3.750	2	C41623	C41556	C33836
5/8	.6250	.625	1.625	3.750	2	C75191	C75225	C75259
5/8	.6250	.625	2.000	4.125	2	C41721	C39091	C39120
41/64	.6406	.625	1.313	3.750	2	C75192	C75226	C75260
21/32	.6563	.625	1.313	3.750	2	C75193	C75227	C75261
11/16	.6875	.500	1.313	3.625	2	C41625	C33781	C33837
11/16	.6875	.625	1.313	3.750	2	C41626	C33782	C33838
11/16	.6875	.750	2.250	4.500	2	C39075	C39092	C39121
23/32	.7188	.500	1.313	3.313	2	C75194	C75228	C75262
23/32	.7188	.750	1.313	3.875	2	C75195	C75229	C75263
47/64	.7344	.750	1.313	3.875	2	C75196	C75230	C75264
3/4	.7500	.500	1.313	3.625	2	C41628	C33783	C33839
3/4	.7500	.625	1.313	3.750	2	C41629	C33784	C33840
3/4	.7500	.750	.750	3.000	2	C75197	C75231	C75265
3/4	.7500	.750	1.313	3.875	2	C41630	C41557	C33841
3/4	.7500	.750	1.750	4.000	2	C75198	C75232	C75266
3/4	.7500	.750	2.250	4.500	2	C41724	C39093	C39122
25/32	.7813	.750	1.500	4.250	2	C75199	C75233	C75267
13/16	.8125	.625	1.500	4.000	2	C41632	C33785	C38900
13/16	.8125	.750	1.500	4.125	2	C75200	C75234	C75268
13/16	.8125	.875	2.500	4.750	2	C39076	C39094	C39123
27/32	.8438	.875	1.500	4.250	2	C75201	C75235	C75269
7/8	.8750	.625	1.500	4.000	2	C41635	C33786	C38901
7/8	.8750	.750	1.500	4.125	2	C41636	C33787	C38902
7/8	.8750	.875	1.500	4.125	2	C41637	C33788	C38903
7/8	.8750	.875	2.000	4.250	2	C75202	C75236	C75270
7/8	.8750	.875	2.500	4.750	2	C41728	C39095	C39124
29/32	.9063	.875	1.500	4.125	2	C75203	C75237	C75271
15/16	.9375	.625	1.500	4.000	2	C75204	C75238	C75272
15/16	.9375	.750	1.500	4.125	2	C75205	C75239	C75273
15/16	.9375	.875	1.500	4.125	2	C33753	C33789	C38904
15/16	.9375	1.000	3.000	5.500	2	C39077	C39096	C39125
31/32	.9688	1.000	1.625	4.500	2	C75206	C75240	C75274

continued on next page
High Speed Steel
Center Cutting



Style: **HG-2 - Single End** (continued)

Finisher

cutting diameter	decimal equiv.	shank dia d ₂ (in)	length of cut l ₂ (in)	overall length l ₁ (in)	no. of flutes	order number		
						Bright	HG-2 TiN	TiCN
1	1.0000	.500	1.500	3.500	2	C75207	C75241	C75275
1	1.0000	.625	1.500	4.000	2	C41641	C33790	C38905
1	1.0000	.750	1.500	4.125	2	C41642	C33791	C38906
1	1.0000	.875	1.500	4.125	2	C41643	C33792	C38907
1	1.0000	1.000	1.625	4.500	2	C41644	C41558	C38908
1	1.0000	1.000	2.250	4.750	2	C75208	C75242	C75276
1	1.0000	1.000	3.000	5.500	2	C41732	C39097	C39126
1-1/8	1.1250	.750	1.500	3.875	2	C75209	C75243	C75277
1-1/8	1.1250	.875	1.625	4.125	2	C41647	C33793	C38909
1-1/8	1.1250	1.000	1.625	4.500	2	C41648	C33794	C38910
1-1/8	1.1250	1.000	3.000	5.500	2	C41735	—	—
1-1/4	1.2500	.750	1.500	3.875	2	C75210	C75244	C75278
1-1/4	1.2500	.875	1.625	4.125	2	C41650	C33795	C38911
1-1/4	1.2500	1.000	1.625	4.500	2	C41651	C33796	C38912
1-1/4	1.2500	1.250	1.625	4.500	2	C41652	C33797	C38913
1-1/4	1.2500	1.000	3.000	5.500	2	C41737	C39099	C39128
1-1/4	1.2500	1.250	3.000	5.500	2	C41738	C39100	C39129
1-3/8	1.3750	.750	1.500	3.875	2	C75212	C75246	C75280
1-3/8	1.3750	1.000	1.625	4.500	2	C41655	C33798	C38914
1-3/8	1.3750	1.000	3.000	5.500	2	C41741	C39101	C39130
1-1/2	1.5000	1.000	1.625	4.500	2	C41659	C33799	C38915
1-1/2	1.5000	1.250	1.625	4.500	2	C41660	C33800	C38916
1-5/8	1.6250	1.250	1.625	4.500	2	C75213	C75247	C75281
1-5/8	1.6250	1.250	3.000	5.500	2	C41747	C39103	C39132
1-3/4	1.7500	.750	1.500	3.875	2	C75214	C75248	C75282
1-3/4	1.7500	1.250	1.625	4.500	2	C41662	C33801	C38917
1-7/8	1.8750	1.250	1.625	4.500	2	C75215	C75249	C75283
2	2.0000	.750	1.500	3.875	2	C75216	C75250	C75284
2	2.0000	1.250	1.625	4.500	2	C41665	C33802	C38918

High Speed Steel

Center Cutting

Material Reference	Steel (HRC)		Stainless Steel			Cast Iron (HRC)		Aluminum and Non-Ferrous	Hi-Temp Alloy		Hardened Steel (HRC)
	Low Carbon	Alloy	Austenitic	Martensitic	PH	Gray	Nodular		Ni, Co, Fe Based Super Alloy	Titanium	
Hardness	13-38	>38	16-38	> 38	300 Series	400 series					>45
TiN	◆		◆				◆				
TiCN	☆		☆				☆	◆			

☆ = Best Performance ◆ = Acceptable



Style: HG-2M - Single End

HSS
ANSI SIZES
2 Flute CC
Helix 30°
Square End

Surface Treatment

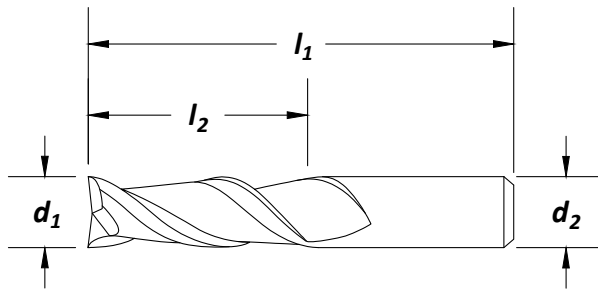

cutting diameter d_1	decimal equiv.	shank dia d_2 (mm)	length of cut l_2 (mm)	overall length l_1 (mm)	no. of flutes	order number HG-2M Bright
3	.1181	9.52	9.52	58.74	2	C75285
4	.1575	9.52	11.11	60.32	2	C75286
5	.1969	9.52	12.70	61.91	2	C75287
6	.2362	9.52	12.70	61.91	2	C75288
7	.2756	9.52	14.29	63.50	2	C75289
8	.3150	9.52	14.29	63.50	2	C75290
9	.3543	9.52	14.29	63.50	2	C75291
10	.3937	9.52	20.64	68.26	2	C75292
11	.4331	9.52	20.64	68.26	2	C75293
12	.4724	12.70	20.64	82.55	2	C75294
13	.5118	12.70	28.57	85.72	2	C75295
14	.5512	12.70	28.57	85.72	2	C75296
15	.5906	12.70	28.57	85.72	2	C75297
16	.6299	15.88	33.34	95.25	2	C75298
17	.6693	15.88	33.34	95.25	2	C75299
18	.7087	15.88	33.34	95.25	2	C75300
19	.7480	19.05	33.34	98.42	2	C75301
20	.7874	15.88	38.10	101.60	2	C75302
24	.9449	25.40	41.27	114.30	2	C75303
25	.9843	25.40	41.27	114.30	2	C75304

High Speed Steel

Center Cutting

Material Reference	Steel (HRc)				Stainless Steel			Cast Iron (HRc)		Aluminum and Non-Ferrous	Hi-Temp Alloy		Hardened Steel (HRc)
	Low Carbon		Alloy		Austenitic	Martensitic	PH	Gray	Nodular		Ni, Co, Fe Based Super Alloy	Titanium	
Hardness	13-38	>38	16-38	> 38	300 Series	400 series		18-22	22-32				>45
Bright	☆		☆					☆		☆			

☆ = Best Performance ◆ = Acceptable



Style: HG-2B - Single End

Finisher

ANSI SIZES

HSS



Surface Treatment

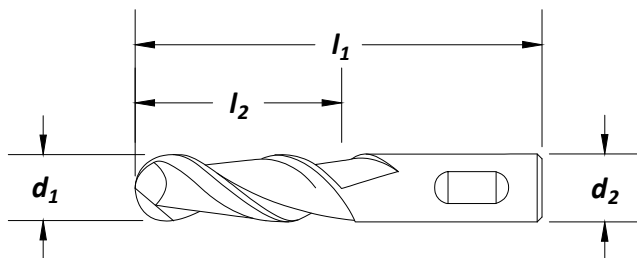

cutting diameter d_1	decimal equiv.	shank dia d_2 (in)	length of cut l_2 (in)	overall length l_1 (in)	no. of flutes	order number		
						Bright	HG-2B TiN	TiCN
1/8	.1250	.375	.375	2.313	2	C42109	C39010	C39027
3/16	.1875	.375	.500	2.375	2	C42111	C39011	C39028
1/4	.2500	.375	.625	2.438	2	C42114	C39012	C39029
5/16	.3125	.375	.750	2.500	2	C42116	C39013	C39030
3/8	.3750	.375	.750	2.500	2	C42119	C39014	C39031
7/16	.4375	.500	1.000	3.250	2	C42122	C39015	C39032
1/2	.5000	.500	1.000	3.250	2	C42124	C39016	C39033
9/16	.5625	.500	1.125	3.375	2	C42126	C39017	C39034
5/8	.6250	.500	1.125	3.375	2	C42128	C39018	C39035
5/8	.6250	.625	1.375	3.750	2	C42129	C39019	C39036
3/4	.7500	.500	1.313	3.625	2	C42132	C39020	C39037
3/4	.7500	.750	1.625	3.875	2	C42133	C39021	C39038
13/16	.8125	.750	2.000	4.250	2	C75305	C75311	C75317
7/8	.8750	.875	2.000	4.250	2	C42137	C39022	C39039
15/16	.9375	.750	2.250	4.500	2	C75306	C75312	C75318
1	1.0000	.750	2.250	4.500	2	C75307	C75313	C75319
1	1.0000	1.000	2.250	4.750	2	C42141	C39023	C39040
1-1/8	1.1250	1.000	2.250	4.750	2	C75308	C75314	C75320
1-1/8	1.1250	1.000	2.250	4.750	2	C42144	C39024	C39041
1-1/4	1.2500	.750	1.500	3.875	2	C75309	C75315	C75321
1-1/4	1.2500	1.250	2.500	5.000	2	C42146	C39025	C39042
1 3/8	1.3750	1.250	2.500	5.063	2	C75310	C75316	C75322
1-1/2	1.5000	1.250	2.500	5.000	2	C42152	C39026	C39043

High Speed Steel

Center Cutting

Material Reference	Steel (HRC)		Stainless Steel			Cast Iron (HRC)		Aluminum and Non-Ferrous	Hi-Temp Alloy		Hardened Steel (HRC)
	Low Carbon	Alloy	Austenitic	Martensitic	PH	Gray	Nodular		Ni, Co, Fe Based Super Alloy	Titanium	
	Hardness	13-38	>38	16-38	> 38	300 Series	400 series	PH	18-22	22-32	
TiN	◆		◆					◆			
TiCN	☆		☆					☆	◆		

☆ = Best Performance ◆ = Acceptable



Note
+.00 /-.0015 tolerances for correct key stock fit.

ANSI SIZES HSS 2 Flute CC Helix 30° Square End

Surface Treatment: Bright, TiN, TiCN

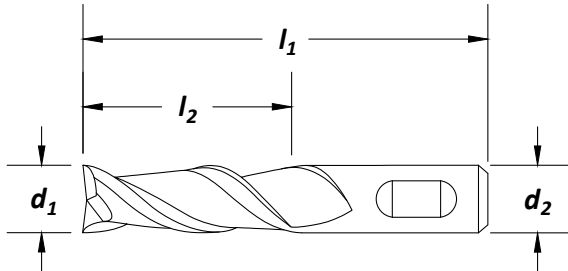

High Speed Steel

Center Cutting

cutting diameter d_1	decimal equiv.	shank dia d_2 (in)	length of cut l_2 (in)	overall length l_1 (in)	no. of flutes	order number		
						Bright	HG-2K TiN	TiCN
1/8	.1250	.375	.375	2.313	2	C41671	C38932	C38957
3/16	.1875	.375	.438	2.375	2	C41673	C38933	C38958
7/32	.2188	.375	.500	2.438	2	C38919	C38934	C38959
1/4	.2500	.375	.500	2.438	2	C41676	C38935	C38960
9/32	.2812	.375	.563	2.500	2	C38920	C38936	C38961
5/16	.3125	.375	.563	2.500	2	C41678	C38937	C38962
11/32	.3438	.375	.563	2.500	2	C38921	C38938	C38963
3/8	.3750	.375	.563	2.500	2	C41681	C38939	C38964
13/32	.4062	.375	.813	2.688	2	C38922	C38940	C38965
7/16	.4375	.375	.813	2.688	2	C38923	C38941	C38966
15/32	.4688	.500	1.000	3.250	2	C38924	C38942	C38967
1/2	.5000	.500	1.000	3.250	2	C41685	C38943	C38968
17/32	.5312	.500	1.125	3.375	2	C38925	C38944	C38969
9/16	.5625	.500	1.125	3.375	2	C38926	C38945	C38970
5/8	.6250	.625	1.313	3.750	2	C41688	C38946	C38971
11/16	.6875	.625	1.313	3.750	2	C38927	C38947	C38972
3/4	.7500	.750	1.313	3.875	2	C41691	C38948	C38973
13/16	.8125	.625	1.500	4.000	2	C38928	C38949	C38974
7/8	.8750	.875	1.500	4.125	2	C41695	C38950	C38975
15/16	.9375	.875	1.500	4.125	2	C38929	C38951	C38976
1	1.0000	1.000	1.625	4.500	2	C41699	C38952	C38977
1-1/8	1.1250	1.000	1.625	4.500	2	C38930	C38953	C38978
1-1/4	1.2500	1.250	1.625	4.500	2	C41703	C38954	C38979
1-3/8	1.3750	1.000	1.625	4.500	2	C38931	C38955	C38980
1-1/2	1.5000	1.250	1.625	4.500	2	C41709	C38956	C38981

Material Reference	Steel (HRc)				Stainless Steel			Cast Iron (HRc)		Aluminum and Non-Ferrous	Hi-Temp Alloy		Hardened Steel (HRc)
	Low Carbon		Alloy		Austenitic	Martensitic	PH	Gray	Nodular		Ni, Co, Fe Based Super Alloy	Titanium	
	Hardness	13-38	>38	16-38	> 38	300 Series	400 series		18-22	22-32			>45
TiN	+		+					+					
TiCN	☆		☆					☆		+			

☆ = Best Performance + = Acceptable



Style: HG-2KS - Single End

Keyway Cutter

Note
+.00 /-.0015 tolerances for correct key stock fit.

Keyway Sizes

HSS



Surface Treatment

Bright

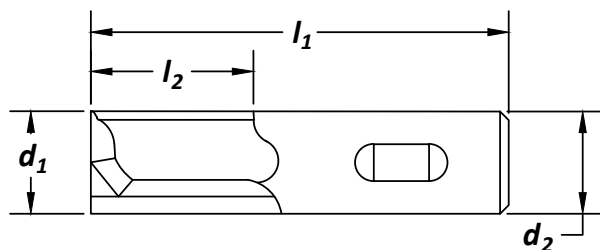

cutting diameter	decimal equiv.	shank dia	length of cut	overall length	key slot width	no. of flutes	order number
d_1		d_2 (in)	l_2 (in)	l_1 (in)	l_3 (in)		HG-2KS Bright
1/8	.1230	.375	.375	2.313	.125	2	C75363
3/16	.1855	.375	.375	2.375	.188	2	C75364
1/4	.2480	.375	.500	2.438	.250	2	C75365
5/16	.3105	.375	.563	2.500	.313	2	C75366
3/8	.3730	.375	.563	2.500	.375	2	C75367
1/2	.4980	.500	1.000	3.250	.500	2	C75368
5/8	.6230	.625	1.313	3.750	.625	2	C75369
3/4	.7480	.750	1.313	3.875	.750	2	C75370
7/8	.8730	.8758	1.500	4.125	.875	2	C75371
1	.9980	1.000	1.625	4.500	1.000	2	C75372

High Speed Steel

Center Cutting

Material Reference	Steel (HRc)		Stainless Steel			Cast Iron (HRc)		Aluminum and Non-Ferrous	Hi-Temp Alloy		Hardened Steel (HRc)
	Low Carbon	Alloy	Austenitic	Martensitic	PH	Gray	Nodular		Ni, Co, Fe Based Super Alloy	Titanium	
Hardness	13-38	>38	16-38	> 38	300 Series	400 series					>45
Bright	☆		☆					☆	☆	◆	

☆ = Best Performance ◆ = Acceptable

Style: HGN-2 - Single End

ANSI SIZES

HSS



Surface Treatment

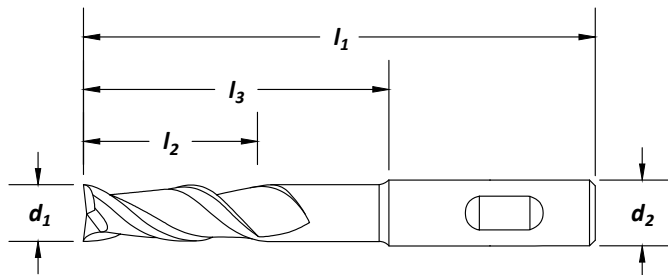

cutting diameter d_1	decimal equiv.	shank dia d_2 (in)	length of cut l_2 (in)	overall length l_1 (in)	reach l_3 (in)	no. of flutes	order number HGN-2 Bright
1/8	.1250	.375	.375	2.375	.813	2	C38982
3/16	.1875	.375	.500	2.688	1.125	2	C38983
1/4	.2500	.375	.625	3.063	1.500	2	C41772
5/16	.3125	.375	.750	3.313	1.750	2	C41774
3/8	.3750	.375	.750	3.313	1.750	2	C41777
7/16	.4375	.500	1.000	3.750	1.875	2	C38984
1/2	.5000	.500	1.000	4.000	2.250	2	C41781
5/8	.6250	.625	1.375	4.625	2.750	2	C41784
3/4	.7500	.750	1.625	5.250	3.375	2	C41787
7/8	.8750	.875	2.000	6.000	4.000	2	C38985
1	1.0000	1.000	2.500	7.250	5.000	2	C41795
1-1/4	1.2500	1.250	3.000	7.250	5.000	2	C41799

High Speed Steel

Center Cutting

Material Reference	Steel (HRc)				Stainless Steel			Cast Iron (HRc)		Aluminum and Non-Ferrous	Hi-Temp Alloy		Hardened Steel (HRc)
	Low Carbon		Alloy		Austenitic	Martensitic	PH	Gray	Nodular		Ni, Co, Fe Based Super Alloy	Titanium	
Hardness	13-38	>38	16-38	> 38	300 Series	400 series		18-22	22-32				>45
Bright	☆		☆					☆		◆			

☆ = Best Performance ◆ = Acceptable

Style: HGN-2B - Single End

Finisher
Extended Neck

ANSI
SIZES

HSS



Surface
Treatment

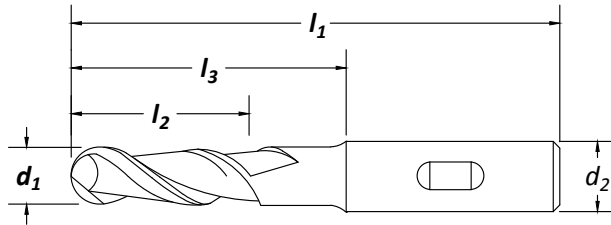

cutting diameter d_1	decimal equiv.	shank dia d_2 (in)	length of cut l_2 (in)	overall length l_1 (in)	reach l_3 (in)	no. of flutes	order number HGN-2B Bright
1/8	.1250	.375	.375	2.375	.813	2	C42158
3/16	.1875	.375	.500	2.688	1.125	2	C42160
1/4	.2500	.375	.625	3.063	1.500	2	C42163
5/16	.3125	.375	.750	3.313	1.750	2	C42165
3/8	.3750	.375	.750	3.313	1.750	2	C42168
7/16	.4375	.500	1.000	3.750	1.875	2	C42171
1/2	.5000	.500	1.000	4.000	2.250	2	C42173
5/8	.6250	.625	1.375	4.625	2.750	2	C42176
3/4	.7500	.750	1.625	5.375	3.375	2	C42179
7/8	.8750	.875	2.000	5.750	4.000	2	C39174
1	1.0000	1.000	2.500	7.250	5.000	2	C42181

High Speed Steel

Center Cutting

Material Reference	Steel (HRC)		Stainless Steel			Cast Iron (HRC)		Aluminum and Non-Ferrous	Hi-Temp Alloy		Hardened Steel (HRC)
	Low Carbon	Alloy	Austenitic	Martensitic	PH	Gray	Nodular		Ni, Co, Fe Based Super Alloy	Titanium	
Hardness	13-38	>38	16-38	> 38	300 Series	400 series					>45
Bright	☆		☆				☆		◆		

☆ = Best Performance ◆ = Acceptable

Style: HGA-2 - Single End

ANSI SIZES

HSS



Surface Treatment

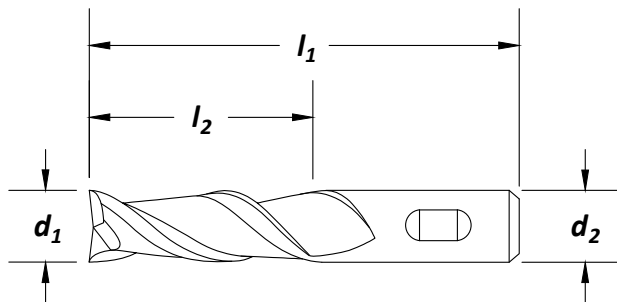

High Speed Steel

Center Cutting

cutting diameter d_1	decimal equiv.	shank dia d_2 (in)	length of cut l_2 (in)	overall length l_1 (in)	no. of flutes	order number		
						Bright	HGA-2 TiN	TiCN
1/4	.2500	.375	.625	2.437	2	C41843	C33476	C33488
1/4	.2500	.375	1.250	3.063	2	C41888	C33500	C33511
1/4	.2500	.375	1.750	3.563	2	C41930	C33524	C33535
5/16	.3125	.375	.750	2.500	2	C41845	—	C33489
5/16	.3125	.375	1.375	3.125	2	C41890	—	C33512
5/16	.3125	.375	2.000	3.750	2	C41932	C33525	C33536
3/8	.3750	.375	.750	2.500	2	C41848	C33478	C33490
3/8	.3750	.375	1.500	3.250	2	C41893	C33502	C33513
3/8	.3750	.375	2.500	4.250	2	C41935	C33526	C33537
7/16	.4375	.375	1.000	2.688	2	C41851	—	C33491
7/16	.4375	.500	1.750	3.750	2	C41896	—	C33514
7/16	.4375	.375	2.750	4.500	2	C33522	—	C33538
1/2	.5000	.500	1.250	3.250	2	C41853	C33480	C33492
1/2	.5000	.500	2.000	4.000	2	C41898	C33504	C33515
1/2	.5000	.500	3.000	5.000	2	C41939	C33528	C33539
5/8	.6250	.625	1.625	3.750	2	C41856	—	C33493
5/8	.6250	.625	2.500	4.625	2	C41901	—	C33516
5/8	.6250	.625	4.000	6.125	2	C41942	—	C33540
3/4	.7500	.750	1.625	3.875	2	C41859	—	C33494
3/4	.7500	.750	3.000	5.250	2	C41904	C33506	C33517
3/4	.7500	.750	4.000	6.250	2	C41945	C33530	C33541
7/8	.8750	.875	1.875	4.125	2	C41863	—	C33495
7/8	.8750	.875	3.500	5.750	2	C32066	—	C33518
7/8	.8750	.875	5.000	7.250	2	C33523	—	C33542
1	1.0000	1.000	2.000	4.500	2	C41867	—	C33496
1	1.0000	1.000	4.000	6.500	2	C41911	—	C33519
1	1.0000	1.000	6.000	8.500	2	C41952	—	C33543

Material Reference	Steel (HRC)				Stainless Steel			Cast Iron (HRC)		Aluminum and Non-Ferrous	Hi-Temp Alloy		Hardened Steel (HRC)
	Low Carbon		Alloy		Austenitic	Martensitic	PH	Gray	Nodular		Ni, Co, Fe Based Super Alloy	Titanium	
	Hardness	13-38	>38	16-38	> 38	300 Series	400 series		18-22	22-32			>45
TiN	◆												
TiCN	☆									☆			

☆ = Best Performance ◆ = Acceptable



Surface Treatment

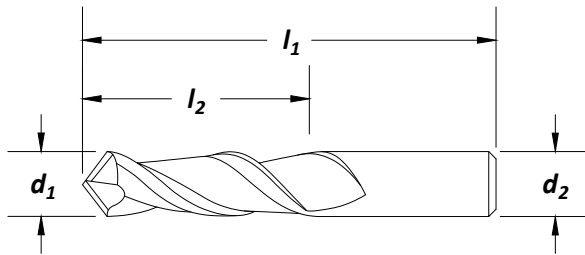

cutting diameter d_1	decimal equiv.	shank dia d_2 (in)	length of cut		no. of flutes	order number		
			l_2 (in)	l_1 (in)		HPDM-2		
						Bright	TiN	TiCN
1/4	.2500	.375	.500	2.313	2	C32430	C40506	C40519
5/16	.3125	.375	.563	2.313	2	C32431	C40507	C40520
3/8	.3750	.375	.563	2.313	2	C32432	C40508	C40521
7/16	.4375	.375	.813	2.500	2	C32433	C40509	C40522
1/2	.5000	.500	1.000	3.000	2	C32434	C40510	C40523
9/16	.5625	.500	1.125	3.125	2	C32435	C40511	C40524
5/8	.6250	.625	1.313	3.438	2	C32436	C40512	C40525
3/4	.7500	.750	1.313	3.563	2	C32438	C40514	C40527
7/8	.8750	.750	1.500	3.750	2	C32440	C40516	C40529
1	1.0000	.750	1.500	3.750	2	C40505	C40518	C40531

TECH TIP

Using Drill Mills

- 90° point allows for rapid plunge cuts.
- Also good for slotting applications.
- 2 flutes deliver enhanced chip ejection.

High Speed Steel

Center Cutting

Material Reference	Steel (HRC)				Stainless Steel			Cast Iron (HRC)		Aluminum and Non-Ferrous	Hi-Temp Alloy		Hardened Steel (HRC)
	Low Carbon		Alloy		Austenitic	Martensitic	PH	Gray	Nodular		Ni, Co, Fe Based Super Alloy	Titanium	
	Hardness	13-38	>38	16-38	> 38	300 Series	400 series		18-22	22-32			>45
Bright	◆		◆					◆					
TiN	◆		◆					◆					
TiCN	☆		☆					☆		☆			

☆ = Best Performance ◆ = Acceptable

General Purpose

Style: **HG-3 - Single End**

ANSI SIZES

HSS



Surface Treatment

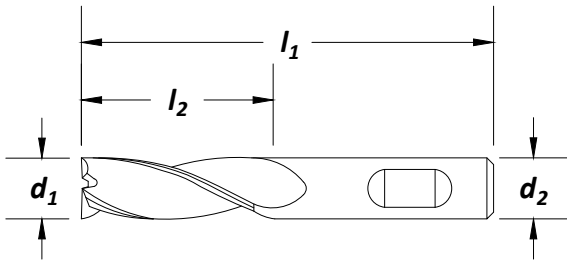

High Speed Steel

Center Cutting

cutting diameter d_1	decimal equiv.	shank dia d_2 (in)	length of cut l_2 (in)	overall length l_1 (in)	no. of flutes	order number		
						Bright	HG-3 TiN	TiCN
1/8	.1250	.375	.375	2.313	3	C39638	C39669	C39700
5/32	.1562	.375	.500	2.375	3	C39639	C39670	C39701
3/16	.1875	.375	.500	2.375	3	C39640	C39671	C39702
3/16	.1875	.375	1.250	3.063	3	C39731	C39753	C39775
7/32	.2188	.375	.625	2.438	3	C39641	C39672	C39703
7/32	.2188	.375	1.250	3.063	3	C39732	C39754	C39776
1/4	.2500	.375	.625	2.438	3	C39642	C39673	C39704
1/4	.2500	.375	1.250	3.063	3	C39733	C39755	C39777
9/32	.2812	.375	.750	2.500	3	C39643	C39674	C39705
9/32	.2812	.375	1.375	3.125	3	C39734	C39756	C39778
5/16	.3125	.375	.750	2.500	3	C39644	C39675	C39706
5/16	.3125	.375	1.375	3.125	3	C39735	C39757	C39779
11/32	.3438	.375	.750	2.500	3	C39645	C39676	C39707
11/32	.3438	.375	1.500	3.250	3	C39736	C39758	C39780
3/8	.3750	.375	.750	2.500	3	C39646	C39677	C39708
3/8	.3750	.375	1.500	3.250	3	C39737	C39759	C39781
13/32	.4062	.375	1.000	2.688	3	C39647	C39678	C39709
13/32	.4062	.500	1.750	3.750	3	C39738	C39760	C39782
7/16	.4375	.375	1.000	2.688	3	C39648	C39679	C39710
7/16	.4375	.500	1.750	3.750	3	C39739	C39761	C39783
15/32	.4688	.500	1.250	3.250	3	C39649	C39680	C39711
15/32	.4688	.500	2.000	4.000	3	C39740	C39762	C39784
1/2	.5000	.375	1.000	2.688	3	C39650	C39681	C39712
1/2	.5000	.500	1.250	3.250	3	C39651	C39682	C39713
1/2	.5000	.500	2.000	4.000	3	C39741	C39763	C39785
9/16	.5625	.500	1.375	3.375	3	C39652	C39683	C39714
5/8	.6250	.625	1.625	3.750	3	C39653	C39684	C39715
5/8	.6250	.625	2.500	4.625	3	C39742	C39764	C39786
11/16	.6875	.625	1.625	3.750	3	C39654	C39685	C39716
3/4	.7500	.750	1.625	3.875	3	C39655	C39686	C39717
3/4	.7500	.750	3.000	5.250	3	C39743	C39765	C39787
13/16	.8125	.625	1.875	4.000	3	C39656	C39687	C39718
7/8	.8750	.875	1.875	4.125	3	C39657	C39688	C39719
7/8	.8750	.875	3.500	5.750	3	C39744	C39766	C39788
15/16	.9375	.875	1.875	4.125	3	C39658	C39689	C39720
1	1.0000	.750	1.875	4.125	3	C39659	C39690	C39721
1	1.0000	1.000	2.000	4.500	3	C39660	C39691	C39722
1	1.0000	1.000	4.000	6.500	3	C39745	C39767	C39789

Material Reference	Steel (HRc)				Stainless Steel			Cast Iron (HRc)		Aluminum and Non-Ferrous	Hi-Temp Alloy		Hardened Steel (HRc)
	Low Carbon		Alloy		Austenitic	Martensitic	PH	Gray	Nodular		Ni, Co, Fe Based Super Alloy	Titanium	
	Hardness	13-38	>38	16-38	> 38	300 Series	400 series		18-22	22-32			>45
TiN	+		+					+					
TiCN	☆		☆					☆		+			

☆ = Best Performance + = Acceptable

Style: **HG-4C** - Single End

ANSI SIZES

HSS



Surface Treatment

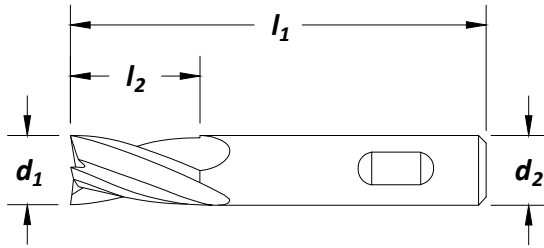

Feature:

Heavy cross-section for high rigidity.

cutting diameter d₁	decimal equiv.	shank dia d₂ (in)	length of cut l₂ (in)	overall length l₁ (in)	no. of flutes	order number		
						Bright	HG-4C TiN	TiCN
1/8	.1250	.375	.375	2.313	4	C41243	C41520	C33240
9/64	.1406	.375	.500	2.375	4	C33141	C33188	C33241
5/32	.1562	.375	.500	2.375	4	C33142	C33189	C33242
11/64	.1719	.375	.500	2.375	4	C33143	C33190	C33243
3/16	.1875	.375	.500	2.375	4	C41245	C41521	C33244
3/16	.1875	.375	1.250	3.063	4	C33371	C33384	C33406
3/16	.1875	.375	1.750	3.563	4	C33428	C33438	C33457
13/64	.2031	.375	.625	2.438	4	C33144	C33191	C33245
7/32	.2188	.375	.625	2.438	4	C33145	C33192	C33246
7/32	.2188	.375	1.250	3.063	4	C33372	C33385	C33407
7/32	.2188	.375	1.750	3.563	4	C33429	C33439	C33458
15/64	.2344	.375	.625	2.438	4	C33146	C33193	C33247
1/4	.2500	.375	.625	2.438	4	C41248	C41522	C33248
1/4	.2500	.375	1.250	3.063	4	C41326	C33386	C33408
1/4	.2500	.375	1.750	3.563	4	C41381	C33440	C33459
17/64	.2656	.375	.750	2.500	4	C33147	C33194	C33249
9/32	.2812	.375	.750	2.500	4	C33148	C33195	C33250
9/32	.2812	.375	1.375	3.125	4	C33373	C33387	C33409
9/32	.2812	.375	2.000	3.750	4	C33430	C33441	C33460
19/64	.2969	.375	.750	2.500	4	C33149	C33196	C33251
5/16	.3125	.375	.750	2.500	4	C41250	C41523	C33252
5/16	.3125	.375	1.375	3.125	4	C41328	C33388	C33410
5/16	.3125	.375	2.000	3.750	4	C41383	C33442	C33461
21/64	.3281	.375	.750	2.500	4	C33150	C33197	C33253
11/32	.3438	.375	.750	2.500	4	C33151	C33198	C33254
11/32	.3438	.375	1.500	3.250	4	C33374	C33389	C33411
11/32	.3438	.375	2.500	4.250	4	C33431	C33443	C33462
23/64	.3594	.375	.750	2.500	4	C33152	C33199	C33255
3/8	.3750	.375	.750	2.500	4	C41253	C41524	C33256
3/8	.3750	.375	1.500	3.250	4	C41331	C33390	C33412
3/8	.3750	.375	2.500	4.250	4	C41386	C33444	C33463
25/64	.3906	.375	1.000	2.688	4	C33153	C33200	C33257
13/32	.4062	.375	1.000	2.688	4	C33154	C33201	C33258
13/32	.4062	.375	2.750	4.500	4	C33432	C33445	C33464
13/32	.4062	.500	1.750	3.750	4	C33375	C33391	C33413

continued on next page

Material Reference	Steel (HRC)				Stainless Steel			Cast Iron (HRC)		Aluminum and Non-Ferrous	Hi-Temp Alloy		Hardened Steel (HRC)
	Low Carbon		Alloy		Austenitic	Martensitic	PH	Gray	Nodular		Ni, Co, Fe Based Super Alloy	Titanium	
	Hardness	13-38	>38	16-38	> 38	300 Series	400 series		18-22	22-32			>45
TiN	★		★					★					
TiCN	★		★					★		★			

★ = Best Performance ◆ = Acceptable

High Speed Steel

Center Cutting

cutting diameter <u>d₁</u>	decimal equiv.	shank dia <u>d₂ (in)</u>	length of cut <u>l₂ (in)</u>	overall length <u>l₁ (in)</u>	no. of flutes	order number		
						Bright	HG-4C TiN	TiCN
27/64	.4219	.375	1.000	2.688	4	C33155	C33202	C33259
7/16	.4375	.375	1.000	2.688	4	C41254	C33203	C33260
7/16	.4375	.375	2.750	4.500	4	C33433	C33446	C33465
7/16	.4375	.500	1.750	3.750	4	C33376	C33392	C33414
29/64	.4531	.500	1.250	3.250	4	C33157	C33204	C33261
15/32	.4688	.500	1.250	3.250	4	C33158	C33205	C33262
15/32	.4688	.500	2.000	4.000	4	C33377	C33393	C33415
15/32	.4688	.500	3.000	5.000	4	C33434	C33447	C33466
31/64	.4844	.500	1.250	3.250	4	C33159	C33206	C33263
1/2	.5000	.375	1.000	2.688	4	C33160	C33207	C33264
1/2	.5000	.500	1.250	3.250	4	C41257	C41525	C33265
1/2	.5000	.500	2.000	4.000	4	C41335	C33394	C33416
1/2	.5000	.500	3.000	5.000	4	C41390	C33448	C33467
17/32	.5312	.500	1.375	3.375	4	C33161	C33208	C33266
9/16	.5625	.500	1.375	3.375	4	C33162	C33209	C33267
19/32	.5938	.500	1.375	3.375	4	C33163	C33210	C33268
5/8	.6250	.500	1.375	3.375	4	C33164	C33211	C33269
5/8	.6250	.625	1.625	3.750	4	C41260	C41526	C33270
5/8	.6250	.625	2.500	4.625	4	C41338	C33395	C33417
5/8	.6250	.625	4.000	6.125	4	C41393	C33449	C33468
21/32	.6562	.625	1.625	3.750	4	C33165	C33212	C33271
11/16	.6875	.500	1.625	3.625	4	C33166	C33213	C33272
11/16	.6875	.625	1.625	3.750	4	C41262	C33214	C33273
23/32	.7188	.750	1.625	3.875	4	C33167	C33215	C33274
3/4	.7500	.500	.875	2.875	4	C75017	C75042	C75067
3/4	.7500	.500	1.625	3.625	4	C33168	C33216	C33275
3/4	.7500	.625	1.625	3.750	4	C33169	C33217	C33276
3/4	.7500	.750	1.625	3.875	4	C41264	C41527	C33277
3/4	.7500	.750	3.000	5.250	4	C41341	C33396	C33418
3/4	.7500	.750	4.000	6.250	4	C41396	C33450	C33469
25/32	.7812	.750	1.875	4.125	4	C33170	C33218	C33278
13/16	.8125	.625	1.875	4.000	4	C33171	C33219	C33279
13/16	.8125	.625	1.875	4.000	6	C75018	C75043	C75068
13/16	.8125	.750	1.875	4.125	4	C75019	C75044	C75069
7/8	.8750	.625	1.875	4.000	4	C33173	C33221	C33281
7/8	.8750	.625	1.875	4.000	6	C75020	C75045	C75070
7/8	.8750	.750	1.000	3.250	4	C75021	C75046	C75071
7/8	.8750	.750	1.875	4.125	4	C33174	C33222	C33282
7/8	.8750	.875	1.875	4.125	4	C41268	C33223	C33283
7/8	.8750	.875	3.500	5.750	4	C41345	C33397	C33419
7/8	.8750	.875	5.000	7.250	4	C41400	C33451	C33470
15/16	.9375	.750	1.875	4.125	4	C75022	C75047	C75072
15/16	.9375	.875	1.875	4.125	4	C33176	C33225	C33285
31/32	.9688	1.000	2.000	4.500	4	C33177	C33226	C33286
1	1.0000	.625	1.875	4.000	4	C33178	C33227	C33287
1	1.0000	.625	1.875	4.000	6	C75023	C75048	C75073
1	1.0000	.750	1.000	3.250	6	C75024	C75049	C75074
1	1.0000	.750	1.875	4.125	4	C33179	C33228	C33288
1	1.0000	.875	1.875	4.125	4	C33180	C33229	C33289
1	1.0000	1.000	2.000	4.500	4	C41272	C41528	C33290
1	1.0000	1.000	3.000	5.500	4	C75025	C75050	C75075
1	1.0000	1.000	4.000	6.500	4	C41349	C33398	C33420
1	1.0000	1.000	6.000	8.500	4	C41404	C33452	C33471
1-1/8	1.1250	.750	1.375	3.625	6	C75026	C75051	C75076
1-1/8	1.1250	.875	2.000	4.500	4	C33181	C33230	C33291

continued on next page

Style: **HG-4C** - Single End (continued)

cutting diameter d₁	decimal equiv.	shank dia d₂ (in)	length of cut l₂ (in)	overall length l₁ (in)	no. of flutes	order number		
						Bright	HG-4C TiN	TiCN
1-1/8	1.1250	1.000	2.000	4.500	4	C41275	C33231	C33292
1-1/8	1.1250	1.000	2.000	4.500	6	C75027	C75052	C75077
1-1/8	1.1250	1.000	4.000	6.500	4	C33378	C33399	C33421
1-1/8	1.1250	1.000	4.000	6.500	6	C75028	C75053	C75078
1-1/4	1.2500	.750	1.375	3.625	6	C75029	C75054	C75079
1-1/4	1.2500	.875	2.000	4.500	4	C33182	C33232	C33293
1 1/4	1.2500	.875	2.000	4.250	6	C75030	C75055	C75080
1-1/4	1.2500	1.000	2.000	4.500	4	C33183	C33233	C33294
1-1/4	1.2500	1.000	2.000	4.500	6	C75031	C75056	C75081
1-1/4	1.2500	1.000	4.000	6.500	4	C33379	C33400	C33422
1-1/4	1.2500	1.250	2.000	4.500	4	C41277	C33234	C33295
1-1/4	1.2500	1.250	2.000	4.500	6	C75032	C75057	C75082
1-1/4	1.1250	1.250	4.000	6.500	4	C41353	C33401	C33423
1-1/4	1.1250	1.250	4.000	6.500	6	C75033	C75058	C75083
1-1/4	1.2500	1.250	6.000	8.500	4	C41408	C33453	C33472
1-1/4	1.2500	1.250	6.000	8.500	6	C33435	C33454	C33473
1-3/8	1.3750	.750	1.375	3.625	6	C75034	C75059	C75084
1-3/8	1.3750	1.000	2.000	4.500	4	C33184	C33235	C33296
1-3/8	1.3750	1.000	2.000	4.500	6	C75035	C75060	C75085
1-1/2	1.5000	.750	1.375	3.625	6	C75036	C75061	C75086
1-1/2	1.5000	1.000	2.000	4.500	6	C33185	C33236	C33297
1-1/2	1.5000	1.000	4.000	6.500	4	C33380	C33402	C33424
1-1/2	1.5000	1.000	4.000	6.500	6	C75037	C75062	—
1-1/2	1.5000	1.250	2.000	4.500	4	C41283	C33237	C33298
1-1/2	1.5000	1.250	2.000	4.500	6	C75038	C75063	C75087
1-1/2	1.5000	1.250	4.000	6.500	4	C33381	C33403	C33425
1-1/2	1.5000	1.250	4.000	6.500	6	C75039	C75064	C75088
1-1/2	1.5000	1.250	8.000	10.500	4	C33436	C33455	C33474
1-1/2	1.5000	1.250	8.000	10.500	6	C33437	C33456	C33475
1-3/4	1.7500	.750	1.375	3.625	6	C75040	C75065	C75089
1-3/4	1.7500	1.250	2.000	4.500	6	C33186	C33238	C33299
1-3/4	1.7500	1.250	4.000	6.500	4	C33382	C33404	C33426
1-3/4	1.7500	1.250	4.000	6.500	6	C75041	C75066	C75090
2	2.0000	1.250	2.000	4.500	8	C33187	C33239	C33300

High Speed Steel
Center Cutting



TECH TIP

Benefits of Multi Flute End Mills

- Generally, multi flute end mills give smoother finishes than 2 flute end mills.
- Increased number of flutes mean more cutting edges, providing more cutting action.

Material Reference	Steel (HRC)				Stainless Steel			Cast Iron (HRC)		Aluminum and Non-Ferrous	Hi-Temp Alloy		Hardened Steel (HRC)
	Low Carbon		Alloy		Austenitic	Martensitic	PH	Gray	Nodular		Ni, Co, Fe Based Super Alloy	Titanium	
Hardness	13-38	>38	16-38	> 38	300 Series	400 series		18-22	22-32				>45
TiN	◆		◆					◆					
TiCN	☆		☆					☆		◆			☆

☆ = Best Performance ◆ = Acceptable

Style: HG-4MC - Single End



Surface Treatment

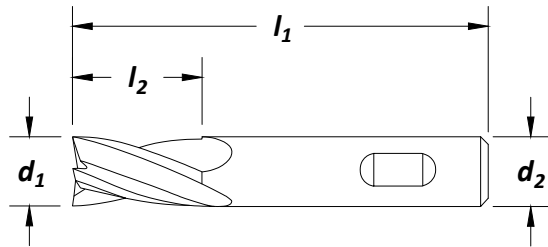

High Speed Steel

Center Cutting

cutting diameter d_1	decimal equiv.	shank dia d_2 (mm)	length of cut l_2 (mm)	overall length l_1 (mm)	no. of flutes	order number HG-4MC Bright
3	.1181	9.52	9.52	58.74	4	C75091
4	.1575	9.52	12.70	60.32	4	C75092
5	.1969	9.52	15.88	61.91	4	C75093
6	.2362	9.52	15.88	61.91	4	C75094
7	.2756	9.52	19.05	63.50	4	C75095
8	.3150	9.52	19.05	63.50	4	C75096
9	.3543	9.52	19.05	63.50	4	C75097
10	.3937	9.52	25.40	68.26	4	C75098
11	.4331	9.52	25.40	68.26	4	C75099
12	.4724	12.70	31.75	82.55	4	C75100
13	.5118	12.70	34.92	85.72	4	C75101
14	.5512	12.70	34.92	85.72	4	C75102
15	.5906	12.70	34.92	85.72	4	C75103
16	.6299	15.88	41.27	95.25	4	C75104
17	.6693	15.88	41.27	95.25	4	C75105
18	.7087	15.88	41.27	95.25	4	C75106
19	.7480	19.05	41.27	95.25	4	C75107
20	.7874	15.88	47.63	101.60	4	C75108
21	.8268	15.88	47.63	101.60	4	C75109
22	.8661	22.23	47.63	104.78	4	C75110
23	.9055	22.23	47.63	104.78	4	C75111
24	.9449	25.40	50.80	114.30	4	C75112
25	.9843	25.40	50.80	114.30	4	C75113

Material Reference	Steel (HRc)				Stainless Steel			Cast Iron (HRc)		Aluminum and Non-Ferrous	Hi-Temp Alloy		Hardened Steel (HRc)
	Low Carbon		Alloy		Austenitic	Martensitic	PH	Gray	Nodular		Ni, Co, Fe Based Super Alloy	Titanium	
Hardness	13-38	>38	16-38	> 38	300 Series	400 series		18-22	22-32				>45
Bright	☆		☆					☆	◆				

☆ = Best Performance ◆ = Acceptable



Style: HG-4B - Single End

General Purpose

ANSI
SIZES

HSS



Surface
Treatment

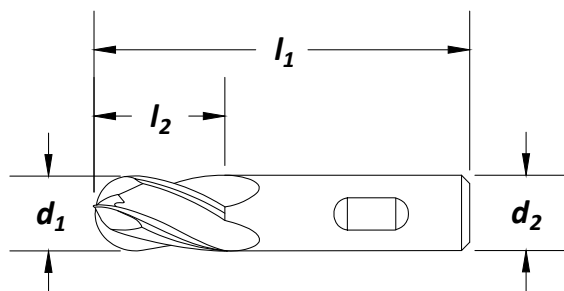

Feature:

Heavy cross-section for high rigidity.

cutting diameter d_1	decimal equiv.	shank dia d_2 (in)	length of cut l_2 (in)	overall length l_1 (in)	no. of flutes	order number		
						Bright	HG-4B TiN	TiCN
1/4	.2500	.375	.625	2.438	4	C33301	C33303	C33313
1/4	.2500	.375	1.250	3.063	4	C33323	C33326	C33335
1/4	.2500	.375	1.750	3.563	4	C33344	C33353	C33362
5/16	.3125	.375	.750	2.500	4	C33302	C33304	C33314
5/16	.3125	.375	1.375	3.125	4	C33324	C33327	C33336
5/16	.3125	.375	2.000	3.750	4	C33345	C33354	C33363
3/8	.3750	.375	.750	2.500	4	C41289	C33305	C33315
3/8	.3750	.375	1.500	3.250	4	C33325	C33328	C33337
3/8	.3750	.375	2.500	4.250	4	C33346	C33355	C33364
1/2	.5000	.500	1.000	3.000	4	C75114	C75115	C75116
1/2	.5000	.500	1.250	3.250	4	C41293	C33306	C33316
1/2	.5000	.500	2.000	4.000	4	C41358	C33329	C33338
1/2	.5000	.500	3.000	5.000	4	C33347	C33356	C33365
5/8	.6250	.625	1.625	3.750	4	C41297	C33307	C33317
5/8	.6250	.625	2.500	4.625	4	C41361	C33330	C33339
5/8	.6250	.625	4.000	6.125	4	C33348	C33357	C33366
3/4	.7500	.750	1.625	3.875	4	C41300	C33308	C33318
3/4	.7500	.750	3.000	5.250	4	C41364	C33331	C33340
3/4	.7500	.750	4.000	6.250	4	C33349	C33358	C33367
7/8	.8750	.875	1.875	4.125	4	C41304	C33309	C33319
1	1.0000	1.000	2.000	4.500	4	C41308	C33310	C33320
1	1.0000	1.000	4.000	6.500	4	C41371	C33332	C33341
1	1.0000	1.000	6.000	8.500	4	C33350	C33359	C33368
1-1/4	1.2500	1.250	2.000	4.500	4	C41312	C33311	C33321
1-1/4	1.2500	1.250	4.000	6.500	4	C41375	C33333	C33342
1-1/2	1.5000	1.250	4.000	6.500	4	C41377	C33334	C33343

High Speed Steel

Center Cutting

Material Reference	Steel (HRC)				Stainless Steel			Cast Iron (HRC)		Aluminum and Non-Ferrous	Hi-Temp Alloy		Hardened Steel (HRC)
	Low Carbon		Alloy		Austenitic	Martensitic	PH	Gray	Nodular		Ni, Co, Fe Based Super Alloy	Titanium	
	Hardness	13-38	>38	16-38	> 38	300 Series	400 series		18-22	22-32			>45
TiN	✦		✦					✦					
TiCN	✦		✦					✦	✦				

✦ = Best Performance ✦ = Acceptable





Surface Treatment

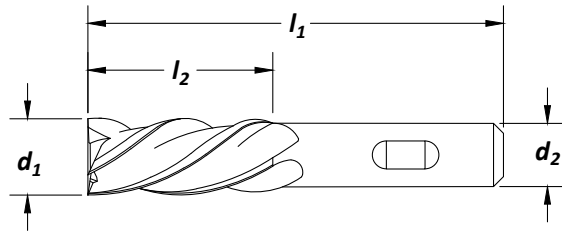

Feature:

Heavy cross-section for high rigidity.

cutting diameter d_1	decimal equiv.	shank dia d_2 (in)	length of cut l_2 (in)	overall length l_1 (in)	no. of flutes	order number		
						Bright	HG-4LL TiN	TiCN
3/16	.1875	.375	.500	2.375	4	C42294	C33610	C33618
1/4	.2500	.375	.625	2.438	4	C42297	C33611	C33619
5/16	.3125	.375	.750	2.500	4	C42299	C33612	C33620
3/8	.3750	.375	.750	2.500	4	C42302	C33613	C33621
7/16	.4375	.375	1.000	2.688	4	C33609	C33614	C33622
1/2	.5000	.500	1.250	3.250	4	C42306	C33615	C33623
5/8	.6250	.625	1.625	3.750	4	C42309	C33616	C33624
3/4	.7500	.750	1.625	3.875	4	C42312	C33617	C33625

High Speed Steel

Center Cutting



Using Style HG-4LL End Mills

- 32° left-hand helix for reverse spindle operation.
- 4 flute design delivers smoother finish.

Material Reference	Steel (HRc)				Stainless Steel			Cast Iron (HRc)		Aluminum and Non-Ferrous	Hi-Temp Alloy		Hardened Steel (HRc)
	Low Carbon		Alloy		Austenitic	Martensitic	PH	Gray	Nodular		Ni, Co, Fe Based Super Alloy	Titanium	
	Hardness	13-38	>38	16-38	> 38	300 Series	400 series		18-22	22-32			>45
Bright	☆		☆					☆		☆			

☆ = Best Performance ◆ = Acceptable



Styles: **CRE**

Corner Radius

ANSI SIZES

HSS

Corner Round

Surface Treatment

Bright

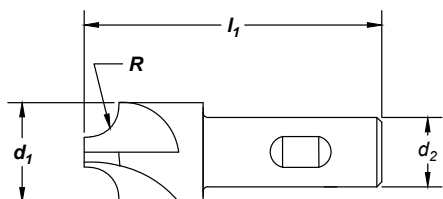

cutting diameter	decimal	shank dia	overall length	no. of	radius	order number
d_1	equiv.	d_2 (in)	l_1 (in)	flutes	R (in)	CRE Bright
7/16	.4375	.375	2.500	4	.0625	C75373
1/2	.500	.375	2.500	4	.0938	C75374
5/8	.625	.500	3.000	4	.1250	C75375
3/4	.750	.500	3.000	4	.1562	C75376
7/8	.875	.500	2.938	4	.1875	C75377
7/8	.875	.750	3.125	4	.1875	C75378
1	1.000	.500	3.000	4	.2500	C75379
1	1.000	.750	3.250	4	.2500	C75380
1-1/8	1.125	.500	3.250	4	.3125	C75381
1-1/8	1.125	.875	3.500	4	.3125	C75382
1-1/4	1.250	.500	3.500	4	.3750	C75383
1-1/4	1.250	.875	3.750	4	.3750	C75384
1-3/8	1.375	1.000	4.000	4	.4375	C75385
1-1/2	1.500	1.000	4.125	4	.5000	C75386

High Speed Steel

Center Cutting

Material Reference	Steel (HRC)		Stainless Steel			Cast Iron (HRC)		Aluminum and Non-Ferrous	Hi-Temp Alloy		Hardened Steel (HRC)
	Low Carbon	Alloy	Austenitic	Martensitic	PH	Gray	Nodular		Ni, Co, Fe Based Super Alloy	Titanium	
Hardness	13-38	>38	16-38	> 38	300 Series	400 series					>45
Bright	☆		☆				☆	◆			

☆ = Best Performance ◆ = Acceptable



Miniature

Style: HMDC-2 - Double End

Note
Operating parameters begin on page 310.

M42
Cobalt

ANSI
SIZES



Surface
Treatment

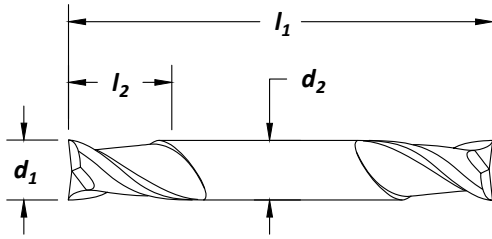

Feature:

High red hardness for high heat conditions.

Cobalt
Center Cutting

cutting diameter d_1	decimal equiv.	shank dia d_2 (in)	length of cut l_2 (in)	overall length l_1 (in)	no. of flutes	order number HMDC-2	
						Bright	TiCN
1/32	.0312	.188	.047	2.000	2	C40936	C40958
1/32	.0312	.188	.094	2.250	2	C40903	C40925
3/64	.0469	.188	.063	2.000	2	C40937	C40959
3/64	.0469	.188	.141	2.250	2	C40904	C40926
1/16	.0625	.188	.094	2.000	2	C40938	C40960
1/16	.0625	.188	.188	2.250	2	C40905	C40927
5/64	.0781	.188	.125	2.000	2	C40939	C40961
5/64	.0781	.188	.234	2.250	2	C40906	C40928
3/32	.0938	.188	.141	2.000	2	C40940	C40962
3/32	.0938	.188	.281	2.250	2	C40907	C40929
7/64	.1094	.188	.156	2.000	2	C40941	C40963
7/64	.1094	.188	.328	2.250	2	C40908	C40930
1/8	.1250	.188	.188	2.000	2	C40942	C40964
1/8	.1250	.188	.375	2.250	2	C40909	C40931
9/64	.1406	.188	.219	2.000	2	C40943	C40965
9/64	.1406	.188	.406	2.250	2	C40910	C40932
5/32	.1562	.188	.234	2.000	2	C40944	C40966
5/32	.1562	.188	.438	2.250	2	C40911	C40933
11/64	.1719	.188	.250	2.000	2	C40945	C40967
11/64	.1719	.188	.500	2.250	2	C40912	C40934
3/16	.1875	.188	.281	2.000	2	C40946	C40968
3/16	.1875	.188	.500	2.250	2	C40913	C40935

Material Reference	Steel (HRc)				Stainless Steel			Cast Iron (HRc)		Aluminum and Non-Ferrous	Hi-Temp Alloy		Hardened Steel (HRc)
	Low Carbon		Alloy		Austenitic	Martensitic	PH	Gray	Nodular		Ni, Co, Fe Based Super Alloy	Titanium	
	Hardness	13-38	>38	16-38	> 38	300 Series	400 series		18-22	22-32			>45
Bright	◆		◆					◆					
TiCN	☆		☆		◆	◆		☆			◆		

☆ = Best Performance ◆ = Acceptable

Note
Operating parameters begin on page 310.

M42
Cobalt

ANSI
SIZES



Surface
Treatment

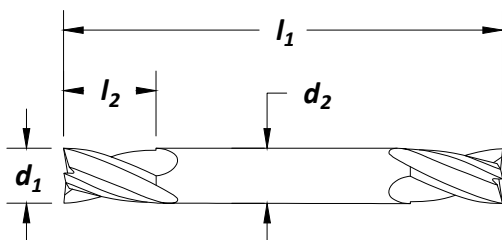

cutting diameter d_1	decimal equiv.	shank dia d_2 (in)	length of cut l_2 (in)	overall length l_1 (in)	no. of flutes	order number	
						HMDC-4	
						Bright	TiCN
1/16	.0625	.188	.094	2.000	4	C40984	C40994
1/16	.0625	.188	.188	2.250	4	C40969	C40979
3/32	.0938	.188	.141	2.000	4	C40985	C40995
3/32	.0938	.188	.281	2.250	4	C40970	C40980
1/8	.1250	.188	.188	2.000	4	C40986	C40996
1/8	.1250	.188	.375	2.250	4	C40971	C40981
5/32	.1562	.188	.234	2.000	4	C40987	C40997
3/16	.1875	.188	.281	2.000	4	C40988	C40998
3/16	.1875	.188	.500	2.250	4	C40973	C40983

TECH TIP

Miniature End Mill Features

- All miniature end mills feature 3/16" shanks.
- Only one holder size needed for all cutting diameters.
- Double end mills are available in multiple lengths.
- Double end mills have two cutting ends to reduce tool costs.

Material Reference	Steel (HRc)				Stainless Steel			Cast Iron (HRc)		Aluminum and Non-Ferrous	Hi-Temp Alloy		Hardened Steel (HRc)
	Low Carbon		Alloy		Austenitic	Martensitic	PH	Gray	Nodular		Ni, Co, Fe Based Super Alloy	Titanium	
	Hardness	13-38	>38	16-38	> 38	300 Series	400 series		18-22	22-32			>45
Bright	◆		◆					◆					
TiCN	☆		☆		◆	◆		☆			◆	◆	

☆ = Best Performance ◆ = Acceptable

Finisher

Style: HDC-2 - Double End

Note
Operating parameters begin on page 310.

M42
Cobalt

ANSI
SIZES



Surface
Treatment

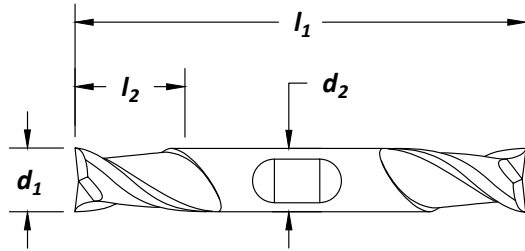

Feature:

High red hardness for high heat conditions.

cutting diameter d_1	decimal equiv.	shank dia d_2 (in)	length of cut l_2 (in)	overall length l_1 (in)	no. of flutes	order number		
						Bright	TiN	TiCN
1/8	.1250	.375	.375	3.063	2	C52151	C32847	C32880
9/64	.1406	.375	.438	3.125	2	C32833	-	-
5/32	.1562	.375	.438	3.125	2	C52152	-	C32882
11/64	.1719	.375	.438	3.250	2	C32834	-	-
3/16	.1875	.375	.438	3.250	2	C52153	C32851	C32884
13/64	.2031	.375	.500	3.250	2	C32835	-	C32885
7/32	.2188	.375	.500	3.250	2	C52154	-	C32886
15/64	.2344	.375	.500	3.375	2	C32836	-	C32887
1/4	.2500	.375	.500	3.375	2	C52155	C32855	C32888
17/64	.2656	.375	.563	3.375	2	C32837	-	C32889
9/32	.2812	.375	.563	3.375	2	C52156	-	C32890
19/64	.2969	.375	.563	3.500	2	C32838	-	-
5/16	.3125	.375	.563	3.500	2	C52157	C32859	C32892
21/64	.3281	.375	.563	3.500	2	C32839	-	-
11/32	.3438	.375	.563	3.500	2	C52158	-	C32894
23/64	.3594	.375	.563	3.500	2	C32840	-	-
3/8	.3750	.375	.563	3.500	2	C52159	C32863	C32896
25/64	.3906	.500	.813	4.125	2	C32841	-	-
13/32	.4062	.500	.813	4.125	2	C52160	-	C32898
27/64	.4219	.500	.813	4.125	2	C32842	-	-
7/16	.4375	.500	.813	4.125	2	C52161	C32867	C32900
29/64	.4531	.500	.813	4.125	2	C32843	-	-
15/32	.4688	.500	.813	4.125	2	C52162	-	-
31/64	.4844	.500	.813	4.125	2	C32844	-	-
1/2	.5000	.500	.813	4.125	2	C52163	C32871	C32904
9/16	.5625	.625	1.125	5.000	2	C52164	C32872	C32905
5/8	.6250	.625	1.125	5.000	2	C52165	C32873	C32906
11/16	.6875	.750	1.313	5.625	2	C52166	C32874	C32907
3/4	.7500	.750	1.313	5.625	2	C52167	C32875	C32908
13/16	.8125	.875	1.563	6.125	2	C32845	C32876	C32909
7/8	.8750	.875	1.563	6.125	2	C52168	C32877	C32910
15/16	.9375	1.000	1.625	6.375	2	C32846	C32878	C32911
1	1.0000	1.000	1.625	6.375	2	C52169	C32879	C32912

Cobalt

Center Cutting

Material Reference	Steel (HRc)				Stainless Steel			Cast Iron (HRc)		Aluminum and Non-Ferrous	Hi-Temp Alloy		Hardened Steel (HRc)
	Low Carbon		Alloy		Austenitic	Martensitic	PH	Gray	Nodular		Ni, Co, Fe Based Super Alloy	Titanium	
	13-38	>38	16-38	> 38	300 Series	400 series		18-22	22-32				
Hardness													
TiN	◆		◆		◆	◆							
TiCN	☆		☆		☆	☆	◆				◆	◆	

☆ = Best Performance ◆ = Acceptable



Style: HDC-4C - Double End

Finisher

Note
Operating parameters begin on page 310.

M42
Cobalt

ANSI
SIZES



Surface
Treatment

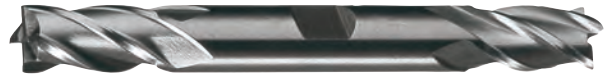
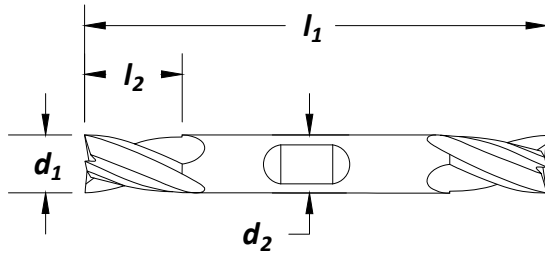

Feature:

High red hardness for high heat conditions.

cutting diameter d₁	decimal equiv.	shank dia d₂ (in)	length of cut l₂ (in)	overall length l₁ (in)	no. of flutes	order number		
						Bright	HDC-4C TiN	TiCN
1/8	.1250	.375	.375	3.063	4	C52170	C32941	C32974
9/64	.1406	.375	.438	3.125	4	C32927	—	C32975
5/32	.1562	.375	.438	3.125	4	C52171	—	C32976
11/64	.1719	.375	.500	3.250	4	C32928	—	C32977
3/16	.1875	.375	.500	3.250	4	C52172	C32945	C32978
13/64	.2031	.375	.563	3.250	4	C32929	—	C32979
7/32	.2188	.375	.563	3.250	4	C52173	—	C32980
15/64	.2344	.375	.625	3.375	4	C32930	—	C32981
1/4	.2500	.375	.625	3.375	4	C52174	C32949	C32982
17/64	.2656	.375	.688	3.375	4	C32931	—	C32983
9/32	.2812	.375	.688	3.375	4	C52175	—	C32984
19/64	.2969	.375	.750	3.500	4	C32932	—	C32985
5/16	.3125	.375	.750	3.500	4	C52176	C32953	C32986
21/64	.3281	.375	.750	3.500	4	C32933	—	C32987
11/32	.3438	.375	.750	3.500	4	C52177	—	C32988
23/64	.3594	.375	.750	3.500	4	C32934	—	C32989
3/8	.3750	.375	.750	3.500	4	C52178	C32957	C32990
25/64	.3906	.500	1.000	4.125	4	C32935	—	C32991
13/32	.4062	.500	1.000	4.125	4	C52179	—	C32992
27/64	.4219	.500	1.000	4.125	4	C32936	—	C32993
7/16	.4375	.500	1.000	4.125	4	C52180	C32961	C32994
29/64	.4531	.500	1.000	4.125	4	C32937	—	C32995
15/32	.4688	.500	1.000	4.125	4	C52181	—	C32996
31/64	.4844	.500	1.000	4.125	4	C32938	—	C32997
1/2	.5000	.500	1.000	4.125	4	C52182	C32965	C32998
9/16	.5625	.625	1.375	5.000	4	C52183	C32966	C32999
5/8	.6250	.625	1.375	5.000	4	C52184	C32967	C33000
11/16	.6875	.750	1.625	5.625	4	C52185	—	C33001
3/4	.7500	.750	1.625	5.625	4	C52186	C32969	C33002
13/16	.8125	.875	1.875	6.125	4	C32939	—	C33003
7/8	.8750	.875	1.875	6.125	4	C52187	—	C33004
15/16	.9375	1.000	1.875	6.375	4	C32940	C32972	C33005
1	1.0000	1.000	1.875	6.375	4	C52188	C32973	C33006

Cobalt

Center Cutting

Material Reference	Steel (HRC)				Stainless Steel			Cast Iron (HRC)		Aluminum and Non-Ferrous	Hi-Temp Alloy		Hardened Steel (HRC)
	Low Carbon		Alloy		Austenitic	Martensitic	PH	Gray	Nodular		Ni, Co, Fe Based Super Alloy	Titanium	
	Hardness	13-38	>38	16-38	> 38	300 Series	400 series		18-22	22-32			>45
TiN	★		★		★	★							
TiCN	☆		☆		☆	☆	★				★	★	

☆ = Best Performance ★ = Acceptable



Finisher

Style: HGC-2 - Single End

Note
Operating parameters begin on page 310.

ANSI SIZES

M42 Cobalt



Surface Treatment

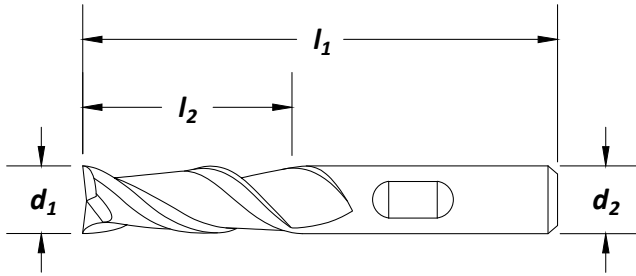

Feature:

High red hardness for high heat conditions.

Cobalt

Center Cutting

cutting diameter	decimal equiv.	shank dia d ₂ (in)	length of cut l ₂ (in)	overall length l ₁ (in)	no. of flutes	order number		
						Bright	HGC-2 TiN	TiCN
1/8	.1250	.375	.188	2.125	2	C75126	C75136	C75146
1/8	.1250	.375	.375	2.313	2	C42602	C32498	C32527
1/8	.1250	.375	.750	2.625	2	C75127	C75137	C75147
5/32	.1562	.375	.438	2.375	2	C32480	C32499	C32528
11/64	.1719	.375	.438	2.375	2	C32481	C32500	C32529
3/16	.1875	.375	.438	2.375	2	C42604	C32501	C32530
13/64	.2031	.375	.500	2.438	2	C32482	C32502	C32531
7/32	.2188	.375	.500	2.438	2	C32483	C32503	C32532
15/64	.2344	.375	.500	2.438	2	C32484	C32504	C32533
1/4	.2500	.375	.500	2.438	2	C42607	C32505	C32534
17/64	.2656	.375	.563	2.500	2	C32485	C32506	C32535
9/32	.2812	.375	.563	2.500	2	C32486	C32507	C32536
19/64	.2969	.375	.563	2.500	2	C32487	C32508	C32537
5/16	.3125	.375	.563	2.500	2	C42609	C32509	C32538
21/64	.3281	.375	.563	2.500	2	C32488	C32510	C32539
11/32	.3438	.375	.563	2.500	2	C32489	C32511	C32540
23/64	.3594	.375	.563	2.500	2	C32490	C32512	C32541
3/8	.3750	.375	.563	2.500	2	C42612	C32513	C32542
3/8	.3750	.375	1.000	2.750	2	C75128	C75138	C75148
3/8	.3750	.375	1.500	3.250	2	C75129	C75139	C75149
25/64	.3906	.375	.813	2.688	2	C32491	C32514	C32543
13/32	.4062	.375	.813	2.688	2	C32492	C32515	C32544
27/64	.4219	.375	.813	2.688	2	C32493	C32516	C32545
7/16	.4375	.375	.813	2.688	2	C32494	C32517	C32546
29/64	.4531	.500	1.000	3.250	2	C32495	C32518	C32547
15/32	.4688	.500	.813	3.250	2	C32496	C32519	C32548
31/64	.4844	.500	1.000	3.250	2	C32497	C32520	-
1/2	.5000	.375	.813	2.688	2	C75130	C75140	C75150
1/2	.5000	.500	1.000	3.250	2	C42616	C32521	C32550
1/2	.5000	.500	1.500	3.500	2	C75131	C75141	C75151
1/2	.5000	.500	2.000	4.000	2	C75132	C75142	C75152
9/16	.5625	.500	1.125	3.375	2	C75133	C75143	C75153
5/8	.6250	.500	1.125	3.375	2	C75134	C75144	C75154
5/8	.6250	.625	1.313	3.750	2	C42619	C32522	C32551

continued on next page



Style: **HGC-2** - Single End (continued)

Finisher

cutting diameter	decimal equiv.	shank dia d ₂ (in)	length of cut		overall length l ₁ (in)	no. of flutes	order number		
			l ₂ (in)				Bright	HGC-2 TiN	TiCN
3/4	.7500	.500	1.313		3.625	2	C75135	C75145	C75155
3/4	.7500	.750	1.313		3.875	2	C42622	C32523	C32552
3/4	.7500	.750	1.750		4.000	2	C75156	C75165	C75174
3/4	.7500	.750	2.250		4.500	2	C75157	C75166	C75175
7/8	.8750	.625	1.500		4.000	2	C75158	C75167	C75176
7/8	.8750	.750	1.500		4.125	2	C75159	C75168	C75177
1	1.0000	.625	1.500		4.000	2	C75160	C75169	C75178
1	1.0000	.750	1.500		4.125	2	C75161	C75170	C75179
1	1.0000	1.000	1.625		4.500	2	C42629	C32524	C32553
1	1.0000	1.000	2.250		4.750	2	C75162	C75171	C75180
1	1.0000	1.000	3.000		5.500	2	C75163	C75172	C75181
1-1/4	1.2500	.7500	1.625		3.875	2	C75164	C75173	C75182
1-1/4	1.2500	1.250	1.625		4.500	2	C42633	C32525	C32554

Cobalt

Center Cutting

Material Reference	Steel (HRC)				Stainless Steel			Cast Iron (HRC)		Aluminum and Non-Ferrous	Hi-Temp Alloy		Hardened Steel (HRC)
	Low Carbon		Alloy		Austenitic	Martensitic	PH	Gray	Nodular		Ni, Co, Fe Based Super Alloy	Titanium	
Hardness	13-38	>38	16-38	> 38	300 Series	400 series		18-22	22-32				>45
TiN	◆		◆		◆	◆							
TiCN	☆		☆		☆	☆	◆				◆	◆	

☆ = Best Performance ◆ = Acceptable



Finisher

Style: HGC-2B - Single End

Note
Operating parameters begin on page 310.

ANSI SIZES

M42 Cobalt



Surface Treatment

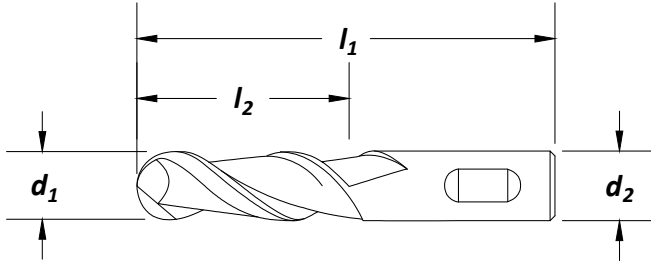

Feature:

High red hardness for high heat conditions.

cutting diameter	decimal equiv.	shank dia d ₂ (in)	length of cut l ₂ (in)	overall length l ₁ (in)	no. of flutes	order number		
						Bright	HGC-2B TiN	TiCN
1/8	.1250	.375	.375	2.313	2	C42643	C32737	C32749
3/16	.1875	.375	.500	2.375	2	C42645	C32738	C32750
1/4	.2500	.375	.625	2.438	2	C42648	C32739	C32751
5/16	.3125	.375	.750	2.500	2	C42650	C32740	C32752
3/8	.3750	.375	.750	2.500	2	C42653	C32741	C32753
1/2	.5000	.500	1.000	3.250	2	C42657	C32742	C32754
5/8	.6250	.625	1.625	3.750	2	C42660	C32743	C32755
3/4	.7500	.750	1.625	3.875	2	C42663	C32744	C32756
7/8	.8750	.875	1.875	4.125	2	C32736	C32745	C32757
1	1.0000	1.000	2.250	4.750	2	C42670	C32746	C32758

Cobalt

Center Cutting

Material Reference	Steel (HRc)				Stainless Steel			Cast Iron (HRc)		Aluminum and Non-Ferrous	Hi-Temp Alloy		Hardened Steel (HRc)
	Low Carbon		Alloy		Austenitic	Martensitic	PH	Gray	Nodular		Ni, Co, Fe Based Super Alloy	Titanium	
	Hardness	13-38	>38	16-38	> 38	300 Series	400 series		18-22	22-32			>45
TiN	◆		◆		◆	◆							
TiCN	☆		☆		☆	☆	◆				◆	◆	

☆ = Best Performance ◆ = Acceptable



Style: HGC-4C - Single End

Finisher

Note
Operating parameters begin on page 310.

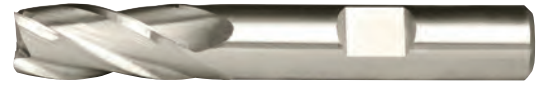
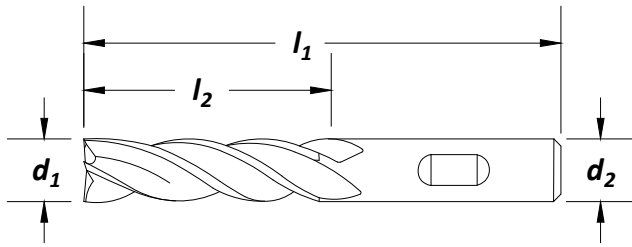

Feature:

High red hardness for high heat conditions. Heavy cross-section for high rigidity.

cutting diameter	decimal equiv.	shank dia d ₂ (in)	length of cut l ₂ (in)	overall length l ₁ (in)	no. of flutes	order number		
						Bright	TiN	TiCN
d ₁						HGC-4C		
1/8	.1250	.375	.375	2.313	4	C42684	C32574	C32610
5/32	.1562	.375	.500	2.375	4	C32556	C32575	C32611
11/64	.1719	.375	.500	2.375	4	C32557	C32576	C32612
3/16	.1875	.375	.500	2.375	4	C42686	C32577	C32613
13/64	.2031	.375	.625	2.438	4	C32558	C32578	C32614
7/32	.2188	.375	.625	2.438	4	C32559	C32579	C32615
15/64	.2344	.375	.625	2.438	4	C32560	C32580	C32616
1/4	.2500	.375	.625	2.438	4	C42689	C32581	C32617
1/4	.2500	.375	1.250	3.063	4	C32646	C32655	C32673
1/4	.2500	.375	1.750	3.563	4	C32691	C32700	C32718
17/64	.2656	.375	.750	2.500	4	C32561	C32582	C32618
9/32	.2812	.375	.750	2.500	4	C32562	C32583	C32619
9/32	.2812	.375	1.375	3.125	4	C32647	C32656	C32674
9/32	.2812	.375	2.000	3.750	4	C32692	C32701	C32719
19/64	.2969	.375	.750	2.500	4	C32563	C32584	C32620
5/16	.3125	.375	.750	2.500	4	C42691	C32585	C32621
5/16	.3125	.375	1.375	3.125	4	C32648	C32657	C32675
5/16	.3125	.375	2.000	3.750	4	C32693	C32702	C32720
21/64	.3281	.375	.750	2.500	4	C32564	C32586	C32622
11/32	.3438	.375	.750	2.500	4	C32565	C32587	C32623
11/32	.3438	.375	1.500	3.250	4	C32649	C32658	C32676
11/32	.3438	.375	2.500	4.250	4	C32694	C32703	C32721
23/64	.3594	.375	.750	2.500	4	C32566	C32588	C32624
3/8	.3750	.375	.750	2.500	4	C42694	C32589	C32625
3/8	.3750	.375	1.500	3.250	4	C42857	C32659	C32677
3/8	.3750	.375	2.500	4.250	4	C42913	C32704	C32722
25/64	.3906	.375	1.000	2.688	4	C32567	C32590	C32626
13/32	.4062	.375	1.000	2.688	4	C32568	C32591	C32627
13/32	.4062	.375	1.750	3.750	4	C32650	C32660	C32678
13/32	.4062	.375	2.750	4.500	4	C32695	C32705	C32723
27/64	.4219	.375	1.000	2.688	4	C32569	C32592	C32628

continued on next page

Material Reference	Steel (HRC)		Stainless Steel			Cast Iron (HRC)		Aluminum and Non-Ferrous	Hi-Temp Alloy		Hardened Steel (HRC)
	Low Carbon	Alloy	Austenitic	Martensitic	PH	Gray	Nodular		Ni, Co, Fe Based Super Alloy	Titanium	
	Hardness	13-38	>38	16-38	> 38	300 Series	400 series				
TiN	◆		◆		◆	◆					
TiCN	☆		☆		☆	☆	◆			◆	◆

☆ = Best Performance ◆ = Acceptable



cutting diameter d ₁	decimal equiv.	shank dia d ₂ (in)	length of cut l ₂ (in)	overall length l ₁ (in)	no. of flutes	order number HGC-4C		
						Bright	TiN	TiCN
7/16	.4375	.375	1.000	2.688	4	C32570	C32593	C32629
7/16	.4375	.375	1.750	3.750	4	C32651	C32661	C32679
7/16	.4375	.375	2.750	4.500	4	C32696	C32706	C32724
29/64	.4531	.500	1.250	3.250	4	C32571	C32594	C32630
15/32	.4688	.500	1.250	3.250	4	C32572	C32595	C32631
15/32	.4688	.500	2.000	4.000	4	C32652	C32662	C32680
15/32	.4688	.500	3.000	5.000	4	C32697	C32707	C32725
31/64	.4844	.500	1.250	3.250	4	C32573	C32596	C32632
1/2	.5000	.500	1.250	3.250	4	C42699	C32597	C32633
1/2	.5000	.500	1.250	3.250	6	C42698	C32598	C32634
1/2	.5000	.500	2.000	4.000	4	C42861	C32663	C32681
1/2	.5000	.500	3.000	5.000	4	C42917	C32708	C32726
5/8	.6250	.625	1.625	3.750	4	C42703	C32599	C32635
5/8	.6250	.625	1.625	3.750	6	C42702	C32600	C32636
5/8	.6250	.625	2.500	4.625	4	C42864	C32664	C32682
5/8	.6250	.625	4.000	6.125	4	C42920	C32709	C32727
3/4	.7500	.750	1.625	3.875	4	C42707	C32601	C32637
3/4	.7500	.750	1.625	3.875	6	C42706	C32602	C32638
3/4	.7500	.750	3.000	5.250	4	C42868	C32665	C32683
3/4	.7500	.750	3.000	5.250	6	C42867	C32666	C32684
3/4	.7500	.750	4.000	6.250	4	C42924	C32710	C32728
3/4	.7500	.750	4.000	6.250	6	C42923	C32711	C32729
7/8	.8750	.875	3.500	5.750	4	C32653	C32667	C32685
7/8	.8750	.875	3.500	5.750	6	C32654	C32668	C32686
1	1.0000	1.000	2.000	4.500	4	C42715	C32603	C32639
1	1.0000	1.000	2.000	4.500	6	C42714	C32604	C32640
1	1.0000	1.000	4.000	6.500	4	C42876	C32669	C32687
1	1.0000	1.000	4.000	6.500	6	C42875	C32670	C32688
1	1.0000	1.000	6.000	8.500	4	C42932	C32712	C32730
1	1.0000	1.000	6.000	8.500	6	C42931	C32713	C32731
1-1/4	1.2500	1.250	2.000	4.500	4	C42720	C32605	C32641
1-1/4	1.2500	1.250	2.000	4.500	6	C42719	C32606	C32642
1-1/4	1.2500	1.250	4.000	6.500	4	C42881	C32671	C32689
1-1/4	1.2500	1.250	4.000	6.500	6	C42880	C32672	C32690
1-1/4	1.2500	1.250	6.000	8.500	4	C42937	C32714	C32732
1-1/4	1.2500	1.250	6.000	8.500	6	C42936	C32715	C32733
1-1/2	1.5000	1.250	2.000	4.500	4	C42727	C32607	C32643
1-1/2	1.5000	1.250	2.000	4.500	6	C42726	C32608	C32644
1-1/2	1.5000	1.250	8.000	10.500	4	C32698	C32716	C32734
1-1/2	1.5000	1.250	8.000	10.500	6	C32699	C32717	C32735
2	2.0000	2.000	4.000	7.750	6	C42731	C32609	C32645

Cobalt

Center Cutting

Material Reference	Steel (HRC)				Stainless Steel			Cast Iron (HRC)		Aluminum and Non-Ferrous	Hi-Temp Alloy		Hardened Steel (HRC)
	Low Carbon		Alloy		Austenitic	Martensitic	PH	Gray	Nodular		Ni, Co, Fe Based Super Alloy	Titanium	
	Hardness	13-38	>38	16-38	> 38	300 Series	400 series		18-22	22-32			>45
TiN	◆		◆		◆	◆							
TiCN	☆		☆		☆	☆	◆				◆	◆	

☆ = Best Performance ◆ = Acceptable

Style: HGC-4B - Single End

Finisher
Multi Flute

Note
Operating parameters
begin on page 310.

ANSI
SIZES

M42
Cobalt

Multi Flute CC

Helix 30°

Ball End

Surface
Treatment

Bright

TiN

TiCN

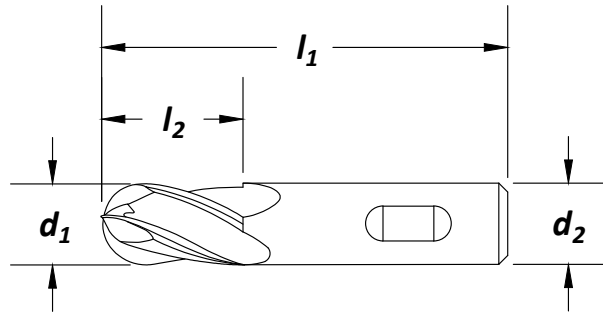

Feature:

High red hardness for high heat conditions. Heavy cross-section for high rigidity.

cutting diameter d_1	decimal equiv.	shank dia d_2 (in)	length of cut l_2 (in)	overall length l_1 (in)	no. of flutes	order number		
						Bright	TiN	TiCN
1/8	.1250	.375	.375	2.313	4	C42778	C32763	C32776
3/16	.1875	.375	.500	2.375	4	C42780	C32764	C32777
1/4	.2500	.375	.625	2.438	4	C42783	C32765	C32778
1/4	.2500	.375	1.750	3.563	4	C75011	C75013	C75015
5/16	.3125	.375	.750	2.500	4	C42785	C32766	C32779
3/8	.3750	.375	.750	2.500	4	C42788	C32767	C32780
1/2	.5000	.500	1.250	3.250	4	C42792	C32768	C32781
5/8	.6250	.625	1.625	3.750	4	C42795	C32769	C32782
3/4	.7500	.750	1.625	3.875	4	C42799	C32770	C32783
3/4	.7500	.750	1.625	3.875	6	C42798	C32771	C32784
3/4	.7500	.750	3.000	5.250	4	C75012	C75014	C75016
1	1.0000	1.000	2.000	4.500	4	C42807	C32772	C32785
1	1.0000	1.000	2.000	4.500	6	C42806	C32773	C32786
1-1/4	1.2500	1.250	2.000	4.500	6	C32761	C32774	C32787
1-1/2	1.5000	1.250	2.000	4.500	6	C32762	C32775	C32788

Cobalt

Center Cutting

Material Reference	Steel (HRC)		Stainless Steel			Cast Iron (HRC)		Aluminum and Non-Ferrous	Hi-Temp Alloy		Hardened Steel (HRC)
	Low Carbon	Alloy	Austenitic	Martensitic	PH	Gray	Nodular		Ni, Co, Fe Based Super Alloy	Titanium	
	Hardness	13-38	>38	16-38	> 38	300 Series	400 series		18-22	22-32	
Bright											
TiN	◆		◆		◆	◆					
TiCN	☆		☆		☆	☆	◆			◆	◆

☆ = Best Performance ◆ = Acceptable

Styles: **RG6, RG6-TC, RG6-TA**

ANSI SIZES M42 Cobalt Multi Flute CC Helix 30° Fine Pitch Square End

Surface Treatment: Bright, TiCN, TiAIN

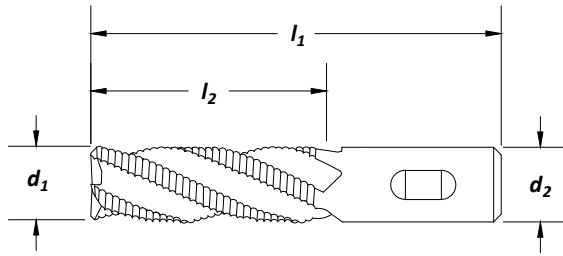

Feature:

Center cutting design for rapid plunge cutting. Heavy cross-section for high rigidity. High red hardness for high heat conditions.

Cobalt
Center Cutting

cutting diameter d_1	decimal equiv.	shank dia d_2 (in)	length of cut l_2 (in)	overall length l_1 (in)	no. of flutes	order number		
						RG6 Bright	RG6-TC TiCN	RG6-TA TiAIN
3/16	.1875	.375	.500	2.375	4	C30733	-	-
1/4	.2500	.375	.250	2.063	4	C31160	C31279	-
1/4	.2500	.375	.625	2.438	4	C30826	C30976	-
1/4	.2500	.375	1.250	3.125	4	C30827	-	-
5/16	.3125	.375	.750	2.500	4	C30828	C30977	-
3/8	.3750	.375	.375	2.156	4	C31161	C31280	-
3/8	.3750	.375	.750	2.500	4	C30829	C30978	C31054
3/8	.3750	.375	1.500	3.250	4	C30830	C30979	C31060
7/16	.4375	.500	1.250	3.250	4	C30734	-	-
1/2	.5000	.500	.500	2.500	4	C31162	C31281	C31056
1/2	.5000	.500	1.250	3.250	4	C30831	C30980	C31055
1/2	.5000	.500	2.000	4.000	4	C30832	C30981	-
5/8	.6250	.625	.625	2.750	4	C31163	C31282	C31053
5/8	.6250	.625	1.625	3.750	4	C30833	C30982	C31044
5/8	.6250	.625	2.500	4.625	4	C30834	C30983	-
3/4	.7500	.750	.750	2.875	4	C30837	C30986	C31058
3/4	.7500	.750	1.625	3.875	4	C30835	C30984	C31057
3/4	.7500	.750	3.000	5.250	4	C30836	C30985	-
7/8	.8750	.875	.875	3.125	5	C31164	C31283	-
7/8	.8750	.875	1.875	4.125	5	C31165	-	-
1	1.0000	1.000	1.000	3.500	5	C31166	C31284	C31063
1	1.0000	1.000	2.000	4.500	5	C30838	C30987	C31059
1	1.0000	1.000	3.000	5.500	5	C30839	C30988	C31087
1	1.0000	1.000	4.000	6.500	5	C30840	C30989	-
1-1/4	1.2500	1.250	2.000	4.500	6	C31167	C31285	C31064
1-1/4	1.2500	1.250	3.000	5.500	6	C31168	C31286	C31098
1-1/4	1.2500	1.250	4.000	6.500	6	C31169	C31287	-

Material Reference	Steel (HRc)				Stainless Steel			Cast Iron (HRc)		Aluminum and Non-Ferrous	Hi-Temp Alloy		Hardened Steel (HRc)
	Low Carbon		Alloy		Austenitic	Martensitic	PH	Gray	Nodular		Ni, Co, Fe Based Super Alloy	Titanium	
	Hardness	13-38	>38	16-38	> 38	300 Series	400 series		18-22	22-32			>45
TiN	◆	◆	◆	◆	◆	◆					◆	☆	
TiAIN	☆	☆	☆	☆	☆	☆	◆						

☆ = Best Performance ◆ = Acceptable

Styles: **RG8, RG8-TC, RG8-TA**

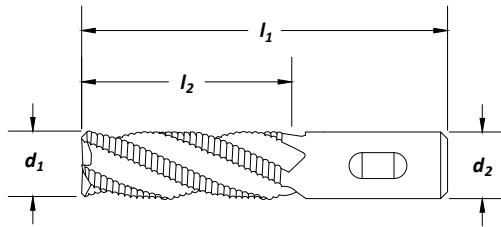

Feature:

Center cutting design for rapid plunge cutting. Heavy cross-section for high rigidity. High red hardness for high heat conditions.

cutting diameter d_1	decimal equiv.	shank dia d_2 (in)	length of cut l_2 (in)	overall length l_1 (in)	no. of flutes	order number		
						RG8 Bright	RG8-TC TiCN	RG8-TA TiAlN
3/16	.1875	.375	.500	2.375	4	C30709	—	—
1/4	.2500	.375	.250	2.063	3	C31173	C31291	—
1/4	.2500	.375	.625	2.438	4	C31174	C31292	—
1/4	.2500	.375	1.250	3.125	4	C31175	—	—
5/16	.3125	.375	.750	2.500	4	C31176	C31293	—
3/8	.3750	.375	.375	2.156	4	C31177	C31294	C31065
3/8	.3750	.375	.750	2.500	4	C31178	C31295	C31067
3/8	.3750	.375	1.500	3.250	4	C31179	C31296	—
7/16	.4375	.500	1.250	3.250	4	C30710	—	—
1/2	.5000	.500	.500	2.500	4	C31180	C31297	C31069
1/2	.5000	.500	1.250	3.250	4	C31181	C31298	C31070
1/2	.5000	.500	2.000	4.000	4	C31182	C31299	C31109
1/2	.5000	.500	3.000	5.000	4	C30732	—	—
5/8	.6250	.625	.625	2.750	4	C31183	C31300	C31071
5/8	.6250	.625	1.625	3.750	4	C31184	C31301	C31072
5/8	.6250	.625	2.500	4.625	4	C31190	C31302	—
3/4	.7500	.750	.750	2.875	4	C31193	C31303	C31074
3/4	.7500	.750	1.625	3.875	4	C31194	C31304	C31075
3/4	.7500	.750	3.000	5.250	4	C31195	C31305	—
3/4	.7500	3/4	4.000	6.250	4	C75344	C75357	—
7/8	.8750	3/4	1.875	4.125	5	C75345	C75358	—
7/8	.8750	7/8	1.875	4.125	5	C75346	C75359	—
1	1.0000	.750	2.000	4.250	5	C75347	—	—
1	1.0000	1.000	2.000	4.500	5	C31197	C31306	C31076
1	1.0000	1.000	3.000	5.500	5	C31198	C31307	C31111
1	1.0000	1.000	4.000	6.500	5	C31199	C31308	—
1-1/8	1.1250	.750	2.000	4.250	6	C75348	—	—
1-1/4	1.2500	.750	2.000	4.250	6	C75349	—	—
1-1/4	1.2500	1.250	4.000	6.500	6	C31205	—	—

continued on next page

Material Reference	Steel (HRC)				Stainless Steel			Cast Iron (HRC)		Aluminum and Non-Ferrous	Hi-Temp Alloy		Hardened Steel (HRC)
	Low Carbon		Alloy		Austenitic	Martensitic	PH	Gray	Nodular		Ni, Co, Fe Based Super Alloy	Titanium	
	Hardness	13-38	>38	16-38	> 38	300 Series	400 series		18-22	22-32			>45
TiN	◆		◆		◆	◆							
TiAlN	☆	◆	☆	◆	☆	☆	◆						

☆ = Best Performance ◆ = Acceptable

cutting diameter d_1	decimal equiv.	shank dia d_2 (in)	length of cut l_2 (in)	overall length l_1 (in)	no. of flutes	order number		
						RG8 Bright	RG8-TC TiCN	RG8-TA TiAlN
1-1/2	1.5000	1.250	2.000	4.250	6	C75350	—	—
1-1/2	1.5000	1.250	2.000	4.500	6	C75351	C75360	—
1-1/2	1.5000	1.250	4.000	6.500	6	C75352	C75387	—
1-1/2	1.5000	1.250	6.000	8.500	6	C75353	C75388	—
2	2.0000	.750	2.000	4.250	8	C75354	—	—
2	2.0000	1.250	2.000	4.500	8	C75355	C75361	—
2	2.0000	1.250	4.000	6.500	8	C75356	C75362	—
2	2.0000	2.000	4.000	7.750	8	C75389	—	—
2	2.0000	2.000	4.000	7.750	6	C31208	C31313	—
2	2.0000	2.000	6.000	9.750	6	C31209	C31314	—
2	2.0000	2.000	6.000	9.750	8	C75390	—	—
2	2.0000	2.000	8.000	11.750	8	C75391	—	—

Cobalt

Center Cutting

Material Reference	Steel (HRc)				Stainless Steel			Cast Iron (HRc)		Aluminum and Non-Ferrous	Hi-Temp Alloy		Hardened Steel (HRc)
	Low Carbon		Alloy		Austenitic	Martensitic	PH	Gray	Nodular		Ni, Co, Fe Based Super Alloy	Titanium	
Hardness	13-38	>38	16-38	> 38	300 Series	400 series		18-22	22-32			>45	
TiN	◆		◆		◆	◆							
TiAlN	☆	◆	☆	◆	☆	☆	◆						

☆ = Best Performance ◆ = Acceptable

Styles: RG9, RG9-TC

Rougher
Extra Coarse Pitch

ANSI SIZES	M42 Cobalt	3 Flute CC	Helix 30°	Course Pitch	45° Chamfer	Square End	Surface Treatment	Bright	TiCN
------------	------------	------------	-----------	--------------	-------------	------------	-------------------	--------	------

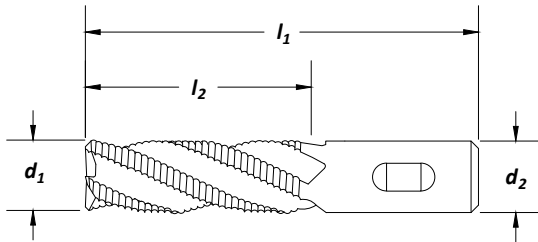

Feature:

Center cutting design for rapid plunge cutting. Heavy cross-section for high rigidity. High red hardness for high heat conditions.

cutting diameter d_1	decimal equiv.	shank dia d_2 (in)	length of cut		no. of flutes	order number	
			l_2 (in)	l_1 (in)		RG9 Bright	RG9-TC TiCN
3/8	.3750	.375	.750	2.500	3	C30780	-
3/8	.3750	.375	1.500	3.250	3	C30720	-
1/2	.5000	.500	1.250	3.250	3	C30781	C31115
1/2	.5000	.500	2.000	4.000	3	C30782	-
1/2	.5000	.500	3.000	5.000	3	C30721	-
5/8	.6250	.625	1.625	3.750	3	C30783	C31117
3/4	.7500	.750	1.625	3.875	3	C30785	C31119
3/4	.7500	.750	2.250	4.500	3	C30786	-
3/4	.7500	.750	3.000	5.250	3	C30722	C31106
3/4	.7500	.750	4.000	6.250	3	C30723	-
7/8	.8750	.750	1.500	3.750	3	C30788	-
7/8	.8750	.875	1.875	4.125	3	C30787	-
1	1.0000	.750	1.500	3.750	3	C30791	-
1	1.0000	1.000	2.000	4.500	3	C30789	C31121
1	1.0000	1.000	3.000	5.500	3	C30790	C31122
1	1.0000	1.000	4.000	6.500	3	C30724	-
1	1.0000	1.000	6.000	8.500	3	C30725	-

Cobalt

Center Cutting

Material Reference	Steel (HRC)		Stainless Steel			Cast Iron (HRC)		Aluminum and Non-Ferrous	Hi-Temp Alloy		Hardened Steel (HRC)
	Low Carbon	Alloy	Austenitic	Martensitic	PH	Gray	Nodular		Ni, Co, Fe Based Super Alloy	Titanium	
Hardness	13-38	>38	16-38	> 38	300 Series	400 series					>45
Bright											☆
TiCN											☆

☆ = Best Performance ◆ = Acceptable

Style: PM-4DE - Double End

Note
Operating parameters begin on page 310.



Surface Treatment

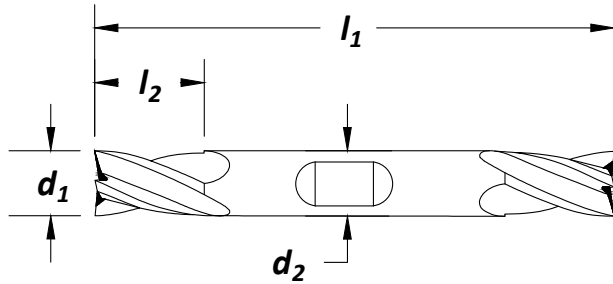

Feature:

Double productivity with double ended end mills.

Powered Metal

Center Cutting

cutting diameter d₁	decimal equiv.	shank dia d₂ (in)	length of cut l₂ (in)	overall length l₁ (in)	no. of flutes	order number PM-4DE	
						Bright	TiCN
1/8	.1250	.375	.375	3.063	4	C52189	C31903
5/32	.1562	.375	.438	3.250	4	C39968	C31904
3/16	.1875	.375	.500	3.250	4	C52190	C31905
7/32	.2188	.375	.563	3.250	4	C39969	C31906
1/4	.2500	.375	.625	3.375	4	C52191	C31907
9/32	.2812	.375	.688	3.375	4	C39970	C31908
5/16	.3125	.375	.750	3.500	4	C52192	C31909
11/32	.3438	.375	.750	3.500	4	C39971	C31910
3/8	.3750	.375	.750	3.500	4	C52193	C31911
13/32	.4062	.500	1.000	4.125	4	C39972	C31912
7/16	.4375	.500	1.000	4.125	4	C52194	C31913
15/32	.4688	.500	1.000	4.125	4	C39973	-
1/2	.5000	.500	1.000	4.125	4	C52195	C31915
9/16	.5625	.625	1.375	5.000	4	C39974	C31916
5/8	.6250	.625	1.375	5.000	4	C52196	C31896
11/16	.6875	.750	1.625	5.625	4	C31879	C31918
3/4	.7500	.750	1.625	5.625	4	C52197	C31919
13/16	.8125	.875	1.875	6.125	4	C31880	-
7/8	.8750	.875	1.875	6.125	4	C52198	C31921
15/16	.9375	1.000	1.875	6.375	4	C31881	-
1	1.0000	1.000	1.875	6.375	4	C52199	C31923

Material Reference	Steel (HRc)				Stainless Steel			Cast Iron (HRc)		Aluminum and Non-Ferrous	Hi-Temp Alloy		Hardened Steel (HRc)
	Low Carbon		Alloy		Austenitic	Martensitic	PH	Gray	Nodular		Ni, Co, Fe Based Super Alloy	Titanium	
	13-38	>38	16-38	>38	300 Series	400 series		18-22	22-32				
Hardness	13-38	>38	16-38	>38	300 Series	400 series	PH	18-22	22-32			>45	
Bright	☆		☆										
TiCN	☆	◆	☆	◆	☆	☆	◆	☆	◆		◆	◆	

☆ = Best Performance ◆ = Acceptable

Note
Operating parameters
begin on page 310.



Surface Treatment

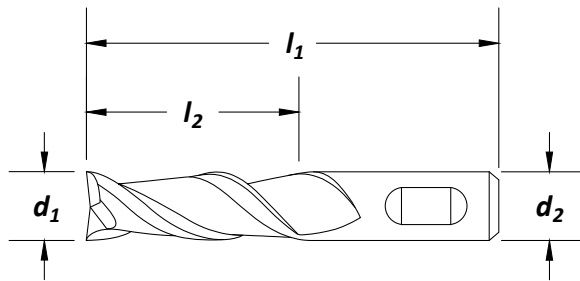

cutting diameter d_1	decimal equiv.	shank dia d_2 (in)	length of cut l_2 (in)	overall length l_1 (in)	no. of flutes	order number		
						Bright	PM-2 TiN	TiCN
1/8	.1250	.375	.375	2.313	2	C40792	C40809	C40826
3/16	.1875	.375	.500	2.375	2	C40793	C40810	C40827
1/4	.2500	.375	.625	2.438	2	C40794	C40811	C40828
5/16	.3125	.375	.750	2.500	2	C40795	C40812	C40829
3/8	.3750	.375	.750	2.500	2	C40796	C40813	C40830
7/16	.4375	.500	1.000	2.688	2	C40797	C40814	C40831
1/2	.5000	.500	1.250	3.250	2	C40798	C40815	C40832
9/16	.5625	.500	1.375	3.375	2	C40799	C40816	C40833
5/8	.6250	.625	1.625	3.750	2	C40800	C40817	C40834
11/16	.6875	.625	1.625	3.750	2	C40801	C40818	C40835
3/4	.7500	.750	1.625	3.875	2	C40802	C40819	C40836
7/8	.8750	.875	1.875	4.125	2	C40803	C40820	C40837
1	1.0000	1.000	2.000	4.500	2	C40804	C40821	C40838

TECH TIP

PM Plus High-Performance End Mills Deliver Superior Performance

- 8% cobalt substrate.
- High vanadium for high red hardness means exceptional toughness and high shock resistance.
- Runs at higher feeds than conventional HSS or cobalt end mills.
- Provide excellent heat and wear resistance.
- Freer cutting minimizes heat build up.
- Gives excellent finish

Material Reference	Steel (HRC)				Stainless Steel			Cast Iron (HRC)		Aluminum and Non-Ferrous	Hi-Temp Alloy		Hardened Steel (HRC)
	Low Carbon		Alloy		Austenitic	Martensitic	PH	Gray	Nodular		Ni, Co, Fe Based Super Alloy	Titanium	
	Hardness	13-38	>38	16-38	> 38	300 Series	400 series		18-22	22-32			>45
Bright	◆		◆							◆			
TiN	☆		☆							◆			
TiCN	☆	◆	☆	◆	◆	◆	◆			☆	◆	◆	

☆ = Best Performance ◆ = Acceptable

Style: PM-3 - Single End

Note
Operating parameters
begin on page 310.



Surface
Treatment

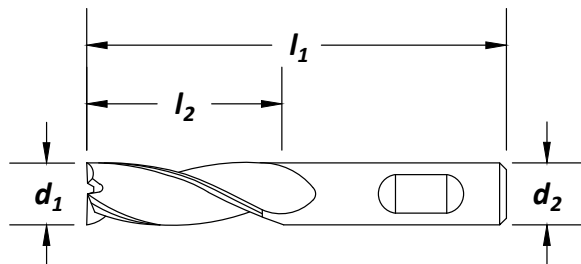

cutting diameter d_1	decimal equiv.	shank dia d_2 (in)	length of cut l_2 (in)	overall length l_1 (in)	no. of flutes	order number	
						Bright	TiCN
1/2	.5000	.500	1.250	3.250	3	C49272	C39950
5/8	.6250	.625	1.625	3.750	3	C49275	C39951
3/4	.7500	.750	1.625	3.875	3	C49277	C39952
3/4	.7500	.750	3.000	5.250	3	C49278	C39962
1	1.0000	1.000	2.000	4.500	3	C49283	C39953
1	1.0000	1.000	3.000	5.500	3	C49284	C39963
1	1.0000	1.000	4.000	6.500	3	C49285	C39964

Powered Metal

Center Cutting

Material Reference	Steel (HRc)				Stainless Steel			Cast Iron (HRc)		Aluminum and Non-Ferrous	Hi-Temp Alloy		Hardened Steel (HRc)
	Low Carbon		Alloy		Austenitic	Martensitic	PH	Gray	Nodular		Ni, Co, Fe Based Super Alloy	Titanium	
Hardness	13-38	>38	16-38	>38	300 Series	400 series		18-22	22-32				>45
Bright	◆		◆							◆			
TiCN	☆	◆	☆	◆	◆	◆	◆			☆	◆	◆	

☆ = Best Performance ◆ = Acceptable

Note
Operating parameters
begin on page 310.

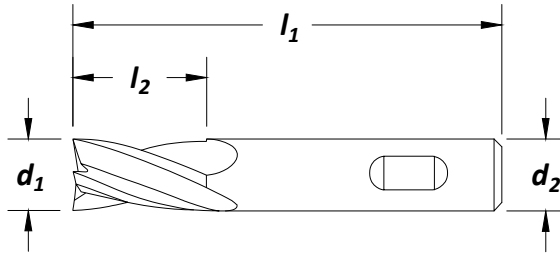

cutting diameter d₁	decimal equiv.	shank dia d₂ (in)	length of cut l₂ (in)	overall length l₁ (in)	no. of flutes	order number		
						Bright	PM-4 TiN	TiCN
1/8	.1250	.375	.250	2.188	4	C43208	C31924	C31939
1/8	.1250	.375	.375	2.313	4	C42500	C31960	C31987
5/32	.1562	.375	.500	2.375	4	C43280	C31961	C31988
3/16	.1875	.375	.250	2.125	4	C43209	C31925	C31940
3/16	.1875	.375	.500	2.375	4	C42502	C31962	C31989
7/32	.2188	.375	.625	2.438	4	C43281	C31963	C31990
1/4	.2500	.375	.250	2.063	4	C43210	C31926	C31941
1/4	.2500	.375	.625	2.438	4	C42504	C31964	C31991
1/4	.2500	.375	1.250	3.063	4	C43290	C32016	C32032
9/32	.2812	.375	.750	2.500	4	C43282	C31965	C31992
5/16	.3125	.375	.375	2.125	4	C43211	C31927	C31942
5/16	.3125	.375	.750	2.500	4	C42506	C31966	C31993
5/16	.3125	.375	1.375	3.125	4	C43291	C32017	C32033
11/32	.3438	.375	.750	2.500	4	C43283	C31967	C31994
3/8	.3750	.375	.375	2.125	4	C43212	C31928	C31943
3/8	.3750	.375	.750	2.500	4	C42508	C31968	C31995
3/8	.3750	.375	1.500	3.250	4	C43292	C32018	C32034
13/32	.4062	.500	1.000	2.688	4	C43284	C31969	C31996
7/16	.4375	.375	1.750	3.750	4	C32014	C32019	C32035
7/16	.4375	.500	.500	2.188	4	C43213	C31929	C31944
7/16	.4375	.500	1.000	2.688	4	C43285	C31970	C31997

continued on next page

TECH TIP

Benefits of Multi Flute End Mills

- Generally, multi flute end mills give smoother finishes than 2 Flute end mills.
- Increased number of flutes mean more cutting edges, providing more cutting action.

Material Reference	Steel (HRC)		Stainless Steel			Cast Iron (HRC)		Aluminum and Non-Ferrous	Hi-Temp Alloy		Hardened Steel (HRC)
	Low Carbon	Alloy	Austenitic	Martensitic	PH	Gray	Nodular		Ni, Co, Fe Based Super Alloy	Titanium	
	Hardness	13-38	>38	16-38	> 38	300 Series	400 series	PH	18-22	22-32	>45
Bright	☆		☆								
TiN	☆		☆								
TiCN	☆	◆	☆	◆	☆	☆	◆	☆	◆	◆	◆

☆ = Best Performance ◆ = Acceptable

cutting diameter d₁	decimal equiv.	shank dia d₂ (in)	length of cut l₂ (in)	overall length l₁ (in)	no. of flutes	order number		
						Bright	PM-4 TiN	TiCN
1/2	.5000	.500	.500	2.500	4	C43214	C31930	C31945
1/2	.5000	.500	1.250	3.250	4	C42510	C31972	C31999
1/2	.5000	.500	2.000	4.000	4	C43293	C32020	C32036
9/16	.5625	.500	1.375	3.375	4	C31955	C31973	C32000
5/8	.6250	.625	.625	2.750	4	C43215	C31931	C31946
5/8	.6250	.625	.625	2.750	6	C43216	C31932	C31947
5/8	.6250	.625	1.625	3.750	4	C42512	C31974	C32001
5/8	.6250	.625	2.500	4.625	4	C43294	C32021	C32037
11/16	.6875	.625	1.625	3.750	4	C31956	C31975	C32002
3/4	.7500	.750	.750	3.000	4	C43217	C31933	C31948
3/4	.7500	.750	.750	3.000	6	C43218	C31934	C31949
3/4	.7500	.750	1.625	3.875	4	C42514	C31976	C32003
3/4	.7500	.750	1.625	3.875	6	C42516	C31977	C32004
3/4	.7500	.750	3.000	5.250	4	C43295	C32022	C32038
13/16	.8125	.875	1.875	4.125	4	C31957	C31978	C32005
7/8	.8750	.875	.875	3.125	4	C43219	C31936	C31951
7/8	.8750	.875	1.250	3.500	4	C43220	C31935	C31950
7/8	.8750	.875	1.875	4.125	4	C31958	C31979	C32006
7/8	.8750	.875	3.500	5.750	4	C32015	C32023	C32039
15/16	.9375	1.000	1.875	4.500	4	C31959	C31980	C32007
1	1.0000	1.000	1.000	3.500	4	C43221	C31938	C31953
1	1.0000	1.000	1.000	3.500	6	C43222	C31937	C31952
1	1.0000	1.000	2.000	4.500	4	C42518	C31981	C32008
1	1.0000	1.000	2.000	4.500	6	C42520	C31982	C32009
1	1.0000	1.000	3.000	5.500	4	C43286	C32024	C32040
1	1.0000	1.000	4.000	6.500	4	C43296	C32025	C32041
1-1/8	1.1250	1.000	2.000	4.500	6	C43223	C31983	C32010
1-1/4	1.2500	1.250	2.000	4.500	6	C43224	C31984	C32011
1-1/4	1.2500	1.250	4.000	6.500	6	C43297	C32027	C32043

Material Reference	Steel (HRc)				Stainless Steel			Cast Iron (HRc)		Aluminum and Non-Ferrous	Hi-Temp Alloy		Hardened Steel (HRc)
	Low Carbon		Alloy		Austenitic	Martensitic	PH	Gray	Nodular		Ni, Co, Fe Based Super Alloy	Titanium	
	13-38	>38	16-38	> 38	300 Series	400 series		18-22	22-32				
Hardness												>45	
Bright	☆		☆										
TiN	☆		☆										
TiCN	☆	◆	☆	◆	☆	☆	◆	☆	◆		◆	◆	

☆ = Best Performance ◆ = Acceptable

Style: PM-4B - Single End
Finisher
PM Plus™
Note

 Operating parameters
 begin on page 310.

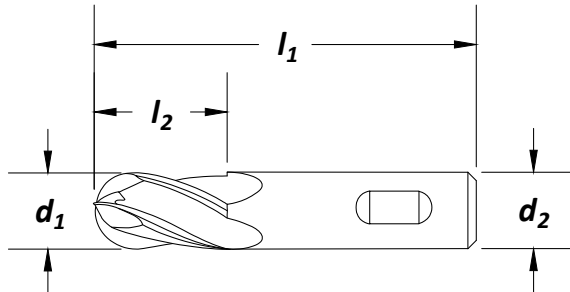
Surface Treatment

cutting diameter d_1	decimal equiv.	shank dia d_2 (in)	length of cut l_2 (in)	overall length l_1 (in)	no. of flutes	order number PM-4B	
						Bright	TiCN
1/8	.1250	.375	.375	2.313	4	C42550	C32057
3/16	.1875	.375	.500	2.375	4	C42552	C32058
1/4	.2500	.375	.625	2.438	4	C42554	C32059
5/16	.3125	.375	.750	2.500	4	C42556	C32060
3/8	.3750	.375	.750	2.500	4	C42558	C32061
1/2	.5000	.500	1.250	3.250	4	C42560	C32062
5/8	.6250	.625	1.625	3.750	4	C42562	C32063
3/4	.7500	.750	1.625	3.875	4	C42564	C32064
1	1.0000	1.000	2.000	4.500	4	C42566	C32065

Powdered Metal
Center Cutting

Material Reference	Steel (HRC)		Stainless Steel			Cast Iron (HRC)		Aluminum and Non-Ferrous	Hi-Temp Alloy		Hardened Steel (HRC)
	Low Carbon	Alloy	Austenitic	Martensitic	PH	Gray	Nodular		Ni, Co, Fe Based Super Alloy	Titanium	
Hardness	13-38	>38	16-38	> 38	300 Series	400 series	PH	18-22	22-32		>45
Bright	☆		☆								
TiCN	☆	◆	☆	◆	☆	☆	◆	☆	◆	◆	◆

☆ = Best Performance ◆ = Acceptable

Style: PM-539R - Single End

Note
Operating parameters begin on page 310.



Surface Treatment

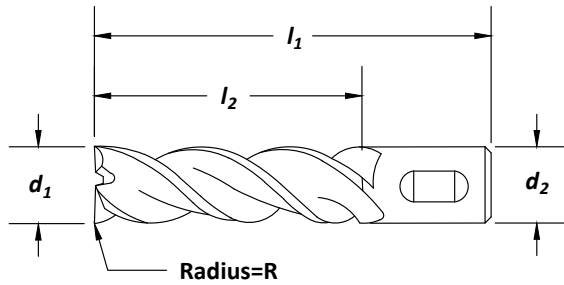

order number

cutting diameter d_1	decimal equiv.	shank dia d_2 (in)	length of cut l_2 (in)	overall length l_1 (in)	no. of flutes	PM-539R				
						Bright R = 0°	TiCN R = 0°	TiCN R = .060°	TiCN R = .090°	TiCN R = .120°
3/8	.3750	.375	.750	2.500	3	C40072	C40073	-	-	-
3/8	.3750	.375	1.500	3.250	3	C40074	C40075	-	-	-
1/2	.5000	.500	1.250	3.250	3	C40076	C40077	-	-	-
1/2	.5000	.500	2.000	4.000	3	C40078	C40079	-	-	-
1/2	.5000	.500	3.000	5.000	3	C40080	C40081	-	-	-
5/8	.6250	.625	1.625	3.750	3	C40082	C40083	-	-	-
5/8	.6250	.625	2.500	4.625	3	C40084	C40085	-	-	-
5/8	.6225	.625	3.000	5.125	3	C40086	C40087	-	-	-
3/4	.7500	.750	1.625	3.875	3	C40345	C40346	C40347	C40348	C40349
3/4	.7500	.750	2.250	4.500	3	C40390	C40391	C40392	C40393	C40394
3/4	.7500	.750	3.000	5.250	3	C40350	C40351	C40352	C40353	C40354
1	1.0000	1.000	2.000	4.500	3	C40355	C40356	C40357	C40358	C40359
1	1.0000	1.000	3.000	5.500	3	C40360	C40361	C40362	C40363	C40364
1	1.0000	1.000	4.000	6.500	3	C40365	C40366	C40367	C40368	C40369
1-1/4	1.2500	1.250	2.000	4.500	3	C40370	-	-	-	C40374
1-1/4	1.2500	1.250	3.000	5.500	3	C40375	-	-	-	C40379
1-1/4	1.2500	1.250	4.000	6.500	3	C40380	-	-	-	C40384
1-1/4	1.2500	1.250	6.000	8.500	3	C40385	-	-	-	-

Powered Metal

Center Cutting

Material Reference	Steel (HRc)		Stainless Steel			Cast Iron (HRc)		Aluminum and Non-Ferrous	Hi-Temp Alloy		Hardened Steel (HRc)
	Low Carbon	Alloy	Austenitic	Martensitic	PH	Gray	Nodular		Ni, Co, Fe Based Super Alloy	Titanium	
Hardness	13-38	>38	16-38	> 38	300 Series	400 series	18-22	22-32			>45
Bright									☆		
TiCN									☆		

☆ = Best Performance ◆ = Acceptable

Style: PM-539L - Single End

Finisher
PM Plus™, Left, High Helix

Note

Left hand spiral.

Left hand cut.

Operating parameters begin on page 310.



Surface Treatment

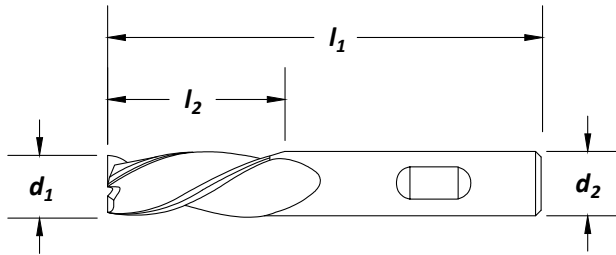

cutting diameter d_1	decimal equiv.	shank dia d_2 (in)	length of cut l_2 (in)	overall length l_1 (in)	no. of flutes	order number PM-539L	
						Bright	TiCN
1/2	.5000	.500	1.250	3.250	3	C40295	–
1/2	.5000	.500	2.000	4.000	3	C40296	–
1/2	.5000	.500	3.000	5.000	3	C40297	–
5/8	.6250	.625	1.625	3.750	3	C40298	–
5/8	.6250	.625	2.500	4.625	3	C40299	–
3/4	.7500	.750	1.625	3.875	3	C40300	C40301
3/4	.7500	.750	3.000	5.250	3	C40305	C40306
1	1.0000	1.000	2.000	4.500	3	C40310	C40311
1	1.0000	1.000	3.000	5.500	3	C40315	C40316
1	1.0000	1.000	4.000	6.500	3	C40320	C40321

TECH TIP

The PM-539 Advantage

- Exceptional speeds in aluminum.
- Quiet, chatter-free machining and high shear cutting.

Powdered Metal

Center Cutting

Material Reference	Steel (HRC)		Stainless Steel			Cast Iron (HRC)		Aluminum and Non-Ferrous	Hi-Temp Alloy		Hardened Steel (HRC)
	Low Carbon	Alloy	Austenitic	Martensitic	PH	Gray	Nodular		Ni, Co, Fe Based Super Alloy	Titanium	
Hardness	13-38	>38	16-38	> 38	300 Series	400 series	PH	18-22	22-32		>45
Bright										☆	
TiCN										☆	

☆ = Best Performance ◆ = Acceptable

Note
Operating parameters begin on page 310.



Surface Treatment

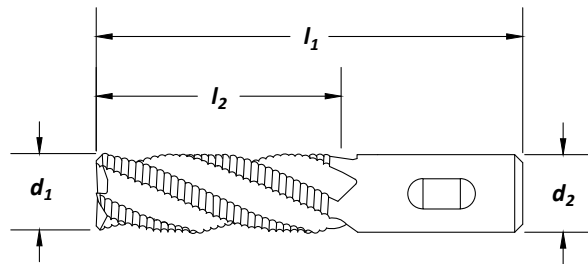

Center Cutting Powered Metal

cutting diameter d_1	decimal equiv.	shank dia d_2 (in)	length of cut		overall length l_1 (in)	no. of flutes	order number		
			l_2 (in)				PMRC-C		
						Bright	TiN	TiCN	
1/4	.2500	.375	.250	2.063	3	C43228	C32213	C32242	
1/4	.2500	.375	.625	2.438	3	C43229	C32214	C32243	
3/8	.3750	.375	.375	2.125	4	C43230	C32215	C32244	
3/8	.3750	.375	.750	2.500	4	C43299	C32216	C32245	
3/8	.3750	.375	1.500	3.250	4	C32210	C32217	C32246	
1/2	.5000	.500	.500	2.500	4	C43231	C32218	C32247	
1/2	.5000	.500	1.250	3.250	4	C43300	C32219	C32248	
1/2	.5000	.500	2.000	4.000	4	C32211	C32220	C32249	
5/8	.6250	.625	.625	2.750	4	C43232	C32221	C32250	
5/8	.6250	.625	1.625	3.750	4	C43301	C32222	C32251	
5/8	.6250	.625	2.500	4.625	4	C32212	C32223	C32252	
3/4	.7500	.750	.750	3.000	4	C43233	C32224	C32253	
3/4	.7500	.750	1.625	3.875	4	C43302	C32225	C32254	
3/4	.7500	.750	3.000	5.250	4	C43303	C32226	C32255	
7/8	.8750	.875	.875	3.125	5	C43234	C32227	C32256	
1	1.0000	1.000	1.000	3.500	5	C43235	C32228	C32257	
1	1.0000	1.000	2.000	4.500	5	C43236	C32229	C32258	
1	1.0000	1.000	3.000	5.500	5	C43304	C32230	C32259	
1	1.0000	1.000	4.000	6.500	5	C43305	C32231	C32260	
1-1/8	1.1250	1.125	2.000	4.500	5	C43237	C32232	C32261	
1-1/4	1.2500	1.250	2.000	4.500	5	C43238	C32233	C32262	
1-1/4	1.2500	1.250	3.000	5.500	5	C43239	C32234	C32263	
1-1/4	1.2500	1.250	4.000	6.500	5	C43306	C32235	C32264	

Material Reference	Steel (HRc)				Stainless Steel			Cast Iron (HRc)		Aluminum and Non-Ferrous	Hi-Temp Alloy		Hardened Steel (HRc)
	Low Carbon		Alloy		Austenitic	Martensitic	PH	Gray	Nodular		Ni, Co, Fe Based Super Alloy	Titanium	
	Hardness	13-38	>38	16-38	> 38	300 Series	400 series		18-22	22-32			>45
Bright	◆									◆			
TiN	◆									☆			
TiCN	◆		◆		◆	◆				☆	◆	◆	

☆ = Best Performance ◆ = Acceptable



Style: PMRF-C - Single End

Note

Operating parameters begin on page 310.



Surface Treatment

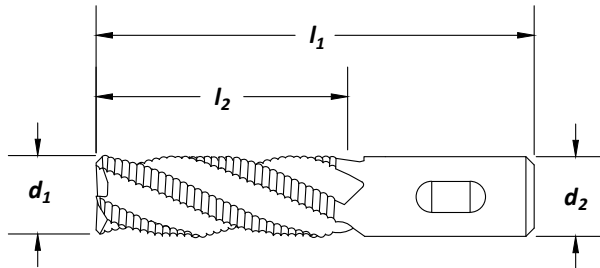

cutting diameter d₁	decimal equiv.	shank dia d₂ (in)	length of cut		no. of flutes	order number		
			l₂ (in)	l₁ (in)		PMRF-C	Bright	TiCN
3/8	.3750	.375	.750	2.500	4	C41122	C41145	C41168
3/8	.3750	.375	1.500	3.250	4	C41134	C41157	C41180
1/2	.5000	.500	1.250	3.250	4	C41123	C41146	C41169
1/2	.5000	.500	2.000	4.000	4	C41135	C41158	C41181
5/8	.6250	.625	1.625	3.750	4	C41124	C41147	C41170
5/8	.6250	.625	2.500	4.625	4	C41136	C41159	C41182
3/4	.7500	.750	1.625	3.875	4	C41125	C41148	C41171
3/4	.7500	.750	2.250	4.500	4	C41130	C41153	C41176
3/4	.7500	.750	3.000	5.250	4	C41137	C41160	C41183
7/8	.8750	.875	1.875	4.125	5	C41126	C41149	C41172
7/8	.8750	.875	3.500	5.750	5	C41138	C41161	C41184
1	1.0000	1.000	2.000	4.500	5	C41127	C41150	C41173
1	1.0000	1.000	3.000	5.500	5	C41131	C41154	C41177
1	1.0000	1.000	4.000	6.500	5	C41139	C41162	C41185
1-1/4	1.2500	1.250	2.000	4.500	6	C41128	C41151	C41174
1-1/4	1.2500	1.250	3.000	5.500	6	C41132	C41155	C41178
1-1/4	1.2500	1.250	4.000	6.500	6	C41140	C41163	C41186
1-1/2	1.5000	1.250	3.000	5.500	6	C41133	C41156	—

Powdered Metal

Center Cutting

Material Reference	Steel (HRC)				Stainless Steel			Cast Iron (HRC)		Aluminum and Non-Ferrous	Hi-Temp Alloy		Hardened Steel (HRC)
	Low Carbon		Alloy		Austenitic	Martensitic	PH	Gray	Nodular		Ni, Co, Fe Based Super Alloy	Titanium	
	Hardness	13-38	>38	16-38	> 38	300 Series	400 series		18-22	22-32			>45
Bright	◆		◆										
TiN	☆		☆										
TiCN	☆	◆	☆	◆	◆	◆					◆	◆	

☆ = Best Performance ◆ = Acceptable

Styles: **PM-538R** - Single End

Note
Operating parameters begin on page 310.



Surface Treatment

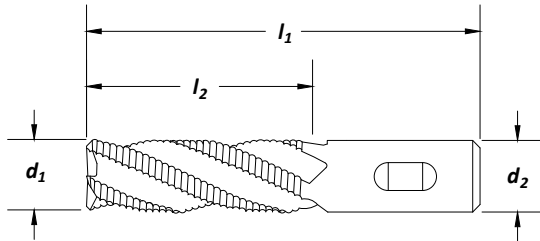

Feature:

For HIGH VOLUME aluminum roughing.

Powered Metal

Center Cutting

cutting diameter d₁	decimal equiv.	shank dia d₂ (in)	length of cut l₂ (in)	overall length l₁ (in)	no. of flutes	order number PM-538R			
						Bright 0° R	TiCN 0° R	TiCN .060° R	TiCN .120°
1/2	.5000	.500	1.250	3.250	3	C40003	C40015	-	-
1/2	.5000	.500	2.000	4.000	3	C40004	C40016	-	-
5/8	.6250	.625	1.625	3.750	3	C40005	C40017	-	-
5/8	.6250	.625	2.500	4.625	3	C40006	C40018	-	-
3/4	.7500	.750	1.625	3.875	3	C40007	C40019	C40033	C40035
3/4	.7500	.750	2.250	4.500	3	C40062	C40063	C40064	C40066
3/4	.7500	.750	3.000	5.250	3	C40008	C40020	C40036	C40038
1	1.0000	1.000	2.000	4.500	3	C40009	C40021	C40039	C40041
1	1.0000	1.000	3.000	5.500	3	C40010	C40022	C40042	C40044
1	1.0000	1.000	4.000	6.500	3	C40011	C40023	C40045	C40047
1-1/4	1.2500	1.250	2.000	4.500	3	C40048	C40049	C40050	C40052
1-1/4	1.2500	1.250	3.000	5.500	3	C40012	C40024	C40053	C40055
1-1/4	1.2500	1.250	4.000	6.500	3	C40013	C40025	C40056	C40058
1-1/4	1.2500	1.250	6.000	8.500	3	C40014	C40026	C40059	C40061
1-1/2	1.5000	1.250	2.000	4.500	3	C43244	C43246	-	-
1-1/2	1.5000	1.250	3.000	5.500	3	C43247	C43249	-	-
1-1/2	1.5000	1.250	4.000	6.500	3	C43250	C43252	-	-
1-1/2	1.5000	1.250	6.000	8.500	3	C43253	C43255	-	-

Material Reference	Steel (HRC)				Stainless Steel			Cast Iron (HRC)		Aluminum and Non-Ferrous	Hi-Temp Alloy		Hardened Steel (HRC)
	Low Carbon		Alloy		Austenitic	Martensitic	PH	Gray	Nodular		Ni, Co, Fe Based Super Alloy	Titanium	
	Hardness	13-38	>38	16-38	> 38	300 Series	400 series		18-22	22-32			>45
Bright										✦			
TiCN										☆			

☆ = Best Performance ✦ = Acceptable

Styles: **PM-538L** - Left, Single End

Rougher - Left
 PM Plus™, Fine Pitch

Note
 Left Hand Spiral.
 Left Hand Cut.



Surface Treatment

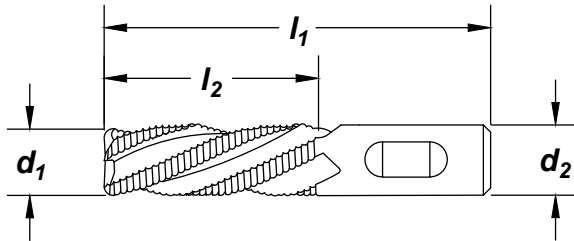

cutting diameter	decimal equiv.	shank dia	length of cut	overall length	no. of flutes	order number
d_1		d_2 (in)	l_2 (in)	l_1 (in)		PM-538L Bright 0° R
3/4	.7500	.750	1.625	3.875	3	C40400
3/4	.7500	.750	3.000	5.250	3	C40405
1	1.0000	1.000	2.000	4.500	3	C40410
1	1.0000	1.000	3.000	5.500	3	C40415
1	1.0000	1.000	4.000	6.500	3	C40420
1-1/4	1.2500	1.250	2.000	4.500	3	C40425
1-1/4	1.2500	1.250	3.000	5.500	3	C40430
1-1/4	1.2500	1.250	4.000	6.500	3	C40435
1-1/4	1.2500	1.250	6.000	8.500	3	C40440

Powdered Metal

Center Cutting

Material Reference	Steel (HRC)		Stainless Steel			Cast Iron (HRC)		Aluminum and Non-Ferrous	Hi-Temp Alloy		Hardened Steel (HRC)
	Low Carbon	Alloy	Austenitic	Martensitic	PH	Gray	Nodular		Ni, Co, Fe Based Super Alloy	Titanium	
Hardness	13-38	>38	16-38	> 38	300 Series	400 series	PH	18-22	22-32		>45
Bright										☆	

☆ = Best Performance ◆ = Acceptable

Note
*Weldon flats available
1/2" and larger.

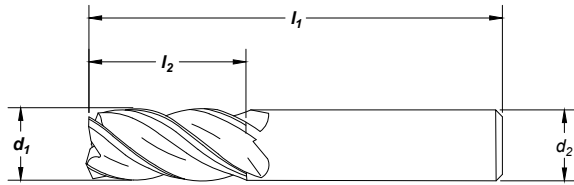

Carbide
Center Cutting

cutting diameter d₁		shank diameter d₂	length of cut l₂ (in)	overall length l₁ (in)	no. of flutes	corner radius	order number CEM-V-4R	
fractional	decimal						bright	AP/MAX
1/8	.1250	1/8	1/4	1-1/2	4	0.000	C60001	C80001
1/8	.1250	1/8	1/4	1-1/2	4	0.010	C60002	C80002
1/8	.1250	1/8	3/8	1-1/2	4	0.000	C60003	C80003
1/8	.1250	1/8	3/8	1-1/2	4	0.010	C60004	C80004
1/8	.1250	1/8	1/2	1-1/2	4	0.000	C60005	C80005
1/8	.1250	1/8	1/2	1-1/2	4	0.010	C60006	C80006
3/16	.1875	3/16	3/8	2	4	0.000	C60007	C80007
3/16	.1875	3/16	3/8	2	4	0.010	C60008	C80008
3/16	.1875	3/16	7/16	2	4	0.000	C60009	C80009
3/16	.1875	3/16	7/16	2	4	0.010	C60010	C80010
3/16	.1875	3/16	3/4	2-1/2	4	0.000	C60011	C80011
3/16	.1875	3/16	3/4	2-1/2	4	0.010	C60012	C80012
1/4	.2500	1/4	1/2	2	4	0.000	C60013	C80013
1/4	.2500	1/4	1/2	2	4	0.020	C60014	C80014
1/4	.2500	1/4	3/4	2-1/2	4	0.000	C60015	C80015
1/4	.2500	1/4	3/4	2-1/2	4	0.020	C60016	C80016
1/4	.2500	1/4	3/4	2-1/2	4	0.045	C60017	C80017
1/4	.2500	1/4	1-1/8	3	4	0.000	C60018	C80018
1/4	.2500	1/4	1-1/8	3	4	0.020	C60019	C80019
1/4	.2500	1/4	1-1/4	3	4	0.000	C60020	C80020
5/16	.3125	5/16	1/2	2	4	0.000	C60021	C80021
5/16	.3125	5/16	1/2	2	4	0.020	C60022	C80022
5/16	.3125	5/16	13/16	2-1/2	4	0.000	C60023	C80023
5/16	.3125	5/16	13/16	2-1/2	4	0.020	C60024	C80024
5/16	.3125	5/16	1-1/4	3	4	0.000	C60025	C80025
5/16	.3125	5/16	1-1/4	3	4	0.020	C60026	C80026
3/8	.3750	3/8	5/8	2	4	0.000	C60027	C80027
3/8	.3750	3/8	5/8	2	4	0.020	C60028	C80028
3/8	.3750	3/8	7/8	2-1/2	4	0.000	C60029	C80029
3/8	.3750	3/8	7/8	2-1/2	4	0.020	C60030	C80030
3/8	.3750	3/8	1-1/8	3	4	0.000	C60031	C80031
3/8	.3750	3/8	1-1/8	3	4	0.020	C60032	C80032
3/8	.3750	3/8	2	4	4	0.000	C60033	C80033
3/8	.3750	3/8	2	4	4	0.020	C60034	C80034

continued on next page

Style: CEM-V-4R (continued)
Variable Index
Ferrous Materials

cutting diameter d₁		shank diameter d₂	length of cut l₂ (in)	overall length l₁ (in)	no. of flutes	corner radius	order number CEM-V-4R	
fractional	decimal						bright	AP/MAX
7/16	.4375	7/16	5/8	2-1/2	4	0.000	C60035	C80035
7/16	.4375	7/16	5/8	2-1/2	4	0.020	C60036	C80036
7/16	.4375	7/16	1	3	4	0.000	C60037	C80037
7/16	.4375	7/16	1	3	4	0.020	C60038	C80038
7/16	.4375	7/16	2	4	4	0.000	C60039	C80039
1/2*	.5000	1/2	5/8	2-1/2	4	0.000	C60040	C80040
1/2*	.5000	1/2	5/8	2-1/2	4	0.020	C60041	C80041
1/2*	.5000	1/2	5/8	2-1/2	4	0.030	C60042	C80042
1/2*	.5000	1/2	1	3	4	0.000	C60043	C80043
1/2*	.5000	1/2	1	3	4	0.030	C60044	C80044
1/2*	.5000	1/2	1	3	4	0.060	C60045	C80045
1/2*	.5000	1/2	1	3	4	0.090	C60046	C80046
1/2*	.5000	1/2	1	3	4	0.125	C60047	C80047
1/2*	.5000	1/2	1-1/4	3	4	0.000	C60048	C80048
1/2*	.5000	1/2	1-1/4	3	4	0.020	C60049	C80049
1/2*	.5000	1/2	1-1/4	3	4	0.030	C60050	C80050
1/2*	.5000	1/2	1-1/4	3	4	0.060	C60051	C80051
1/2*	.5000	1/2	1-1/4	3	4	0.090	C60052	C80052
1/2*	.5000	1/2	1-1/4	3	4	0.125	C60053	C80053
1/2*	.5000	1/2	2	4	4	0.000	C60054	C80054
1/2*	.5000	1/2	2	4	4	0.030	C60055	C80055
1/2*	.5000	1/2	2	4	4	0.060	C60056	C80056
1/2*	.5000	1/2	2	4	4	0.090	C60057	C80057
1/2*	.5000	1/2	2	4	4	0.125	C60058	C80058
5/8*	.6250	5/8	3/4	3	4	0.000	C60059	C80059
5/8*	.6250	5/8	3/4	3	4	0.030	C60060	C80060
5/8*	.6250	5/8	1-1/4	3-1/2	4	0.000	C60061	C80061
5/8*	.6250	5/8	1-1/4	3-1/2	4	0.030	C60062	C80062
5/8*	.6250	5/8	1-1/4	3-1/2	4	0.060	C60063	C80063
5/8*	.6250	5/8	1-1/4	3-1/2	4	0.090	C60064	C80064
5/8*	.6250	5/8	1-1/4	3-1/2	4	0.125	C60065	C80065
5/8*	.6250	5/8	2-1/4	5	4	0.000	C60066	C80066
5/8*	.6250	5/8	2-1/4	5	4	0.030	C60067	C80067
5/8*	.6250	5/8	2-1/4	5	4	0.060	C60068	C80068
5/8*	.6250	5/8	2-1/4	5	4	0.090	C60069	C80069
5/8*	.6250	5/8	2-1/4	5	4	0.125	C60070	C80070

* Weldon flats available on 1/2" and over, please specify when ordering and call customer service for pricing.

continued on next page

Carbide
Center Cutting

Material Reference	Steel (HRC)				Stainless Steel			Cast Iron (HRC)		Aluminum and Non-Ferrous	Hi-Temp Alloy		Hardened Steel (HRC)
	Low Carbon		Alloy		Austenitic	Martensitic	PH	Gray	Nodular		Ni, Co, Fe Based Super Alloy	Titanium	
	13-38	>38	16-38	> 38	300 Series	400 series		18-22	22-32			>45	
Hardness	☆	◆	☆	◆	☆	☆	◆				☆	☆	◆
AP/MAX	☆	◆	☆	◆	☆	☆	◆				☆	☆	◆

☆ = Best Performance ◆ = Acceptable

Style: CEM-V-4R (continued)

cutting diameter d ₁		shank diameter d ₂	length of cut l ₂ (in)	overall length l ₁ (in)	no. of flutes	corner radius	order number CEM-V-4R	
fractional	decimal						bright	AP/MAX
3/4*	.7500	3/4	7/8	3	4	0.030	C60071	C80071
3/4*	.7500	3/4	1	3	4	0.000	C60072	C80072
3/4*	.7500	3/4	1	3	4	0.030	C60073	C80073
3/4*	.7500	3/4	1-1/2	4	4	0.000	C60074	C80074
3/4*	.7500	3/4	1-1/2	4	4	0.030	C60075	C80075
3/4*	.7500	3/4	1-1/2	4	4	0.060	C60076	C80076
3/4*	.7500	3/4	1-1/2	4	4	0.090	C60077	C80077
3/4*	.7500	3/4	1-1/2	4	4	0.125	C60078	C80078
3/4*	.7500	3/4	2-1/4	5	4	0.000	C60079	C80079
3/4*	.7500	3/4	2-1/4	5	4	0.030	C60080	C80080
3/4*	.7500	3/4	2-1/4	5	4	0.060	C60081	C80081
3/4*	.7500	3/4	2-1/4	5	4	0.090	C60082	C80082
3/4*	.7500	3/4	2-1/4	5	4	0.125	C60083	C80083
1*	1.0000	1	1-1/2	4	4	0.000	C60084	C80084
1*	1.0000	1	1-1/2	4	4	0.030	C60085	C80085
1*	1.0000	1	1-1/2	4	4	0.060	C60086	C80086
1*	1.0000	1	1-1/2	4	4	0.090	C60087	C80087
1*	1.0000	1	1-1/2	4	4	0.125	C60088	C80088
1*	1.0000	1	2-1/4	5	4	0.000	C60089	C80089
1*	1.0000	1	2-1/4	5	4	0.030	C60090	C80090
1*	1.0000	1	2-1/4	5	4	0.060	C60091	C80091
1*	1.0000	1	2-1/4	5	4	0.090	C60092	C80092
1*	1.0000	1	2-1/4	5	4	0.125	C60093	C80093
1*	1.0000	1	3	6	4	0.000	C60094	C80094
1*	1.0000	1	3	6	4	0.030	C60095	C80095
1*	1.0000	1	3	6	4	0.060	C60096	C80096
1*	1.0000	1	3	6	4	0.090	C60097	C80097
1*	1.0000	1	3	6	4	0.125	C60098	C80098

* Weldon flats available on 1/2" and over, please specify when ordering and call customer service for pricing.

Carbide

Center Cutting

Material Reference	Steel (HRc)				Stainless Steel			Cast Iron (HRc)		Aluminum and Non-Ferrous	Hi-Temp Alloy		Hardened Steel (HRc)
	Low Carbon		Alloy		Austenitic	Martensitic	PH	Gray	Nodular		Ni, Co, Fe Based Super Alloy	Titanium	
	13-38	>38	16-38	> 38	300 Series	400 series		18-22	22-32				
Hardness													
AP/MAX	☆	◆	☆	◆	☆	☆	◆				☆	☆	◆

☆ = Best Performance ◆ = Acceptable

Styles: CEM-V-4B

Variable Index
Ferrous Materials

Note

*Weldon flats available
1/2" and larger.



Surface Treatment

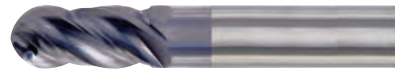
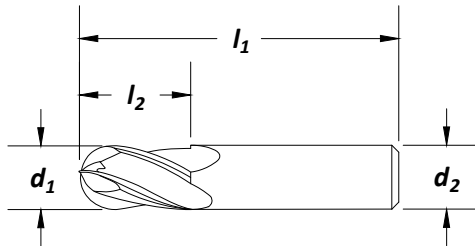

cutting diameter d₁		shank diameter d₂		length of cut l₂ (in)	overall length l₁ (in)	no. of flutes	order number CEM-V-4B	
fractional	decimal						bright	AP/MAX
1/8	.1250	1/8		3/8	1-1/2	4	C60108	C80108
3/16	.1875	3/16		7/16	2	4	C60109	C80109
1/4	.2500	1/4		3/4	2-1/2	4	C60110	C80110
5/16	.3125	5/16		13/16	2-1/2	4	C60111	C80111
3/8	.3750	3/8		7/8	2-1/2	4	C60112	C80112
7/16	.4375	7/16		1	3	4	C60113	C80113
1/2	.5000	1/2		5/8	2-1/2	4	C60114	C60118
1/2*	.5000	1/2		1	3	4	C60115	C80115
5/8*	.6250	5/8		1-1/4	3-1/2	4	C60116	C80116
3/4*	.7500	3/4		1-1/2	4	4	C60117	C80117
1*	1.0000	1		2-1/4	5	4	C60118	C80118

* Weldon flats available on 1/2" and over, please specify when ordering and call customer service for pricing.

Carbide

Center Cutting

Material Reference	Steel (HRC)				Stainless Steel			Cast Iron (HRC)		Aluminum and Non-Ferrous	Hi-Temp Alloy		Hardened Steel (HRC)
	Low Carbon		Alloy		Austenitic	Martensitic	PH	Gray	Nodular		Ni, Co, Fe Based Super Alloy	Titanium	
	Hardness	13-38	>38	16-38	> 38	300 Series	400 series		18-22	22-32			>45
AP/MAX	☆	◆	☆	◆	☆	☆	◆				☆	☆	◆

☆ = Best Performance ◆ = Acceptable

Note

For slotting up to 1 x D.

Minimized chatter from unequal flute spacing.

*Weldon flats available 1/2" and larger.



Surface Treatment

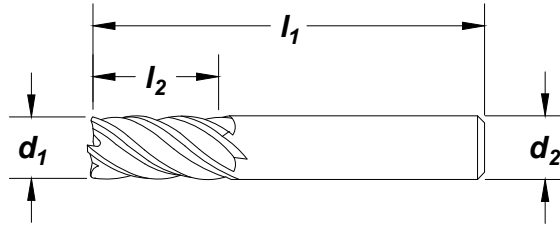

Feature

Use one tool for roughing and finishing operations. **Improved Geometry**

cutting diameter d₁		shank diameter d₂	length of cut l₂ (in)	overall length l₁ (in)	no. of flutes	corner radius	order number CEM-V2-5R	
fractional	decimal						bright	AP/MAX
3/16	.1875	3/16	3/8	2	5	0.000	C60525	C80525
3/16	.1875	3/16	3/8	2	5	0.010	C60526	C80526
3/16	.1875	3/16	7/16	2	5	0.000	C60527	C80527
3/16	.1875	3/16	7/16	2	5	0.010	C60528	C80528
3/16	.1875	3/16	3/4	2-1/2	5	0.000	C60529	C80529
3/16	.1875	3/16	3/4	2-1/2	5	0.010	C60530	C80530
1/4	.2500	1/4	1/2	2	5	0.000	C60531	C80531
1/4	.2500	1/4	1/2	2	5	0.020	C60532	C80532
1/4	.2500	1/4	3/4	2-1/2	5	0.000	C60533	C80533
1/4	.2500	1/4	3/4	2-1/2	5	0.020	C60534	C80534
1/4	.2500	1/4	1-1/8	3	5	0.010	C60535	C80535
1/4	.2500	1/4	1-1/8	3	5	0.020	C60536	C80536
1/4	.2500	1/4	1-1/4	3	5	0.000	C60537	C80537
5/16	.3125	5/16	1/2	2	5	0.000	C60538	C80538
5/16	.3125	5/16	1/2	2	5	0.020	C60539	C80539
5/16	.3125	5/16	13/16	2-1/2	5	0.000	C60540	C80540
5/16	.3125	5/16	13/16	2-1/2	5	0.020	C60541	C80541
5/16	.3125	5/16	1-1/4	3	5	0.000	C60542	C80542
5/16	.3125	5/16	1-1/4	3	5	0.020	C60543	C80543
3/8	.3750	3/8	1/2	2	5	0.030	C60544	C80544
3/8	.3750	3/8	5/8	2	5	0.000	C60545	C80545
3/8	.3750	3/8	5/8	2	5	0.020	C60546	C80546
3/8	.3750	3/8	7/8	2-1/2	5	0.000	C60547	C80547
3/8	.3750	3/8	7/8	2-1/2	5	0.020	C60548	C80548
3/8	.3750	3/8	1-1/8	3	5	0.000	C60549	C80549
3/8	.3750	3/8	1-1/8	3	5	0.020	C60550	C80550
3/8	.3750	3/8	2	4	5	0.000	C60551	C80551
3/8	.3750	3/8	2	4	5	0.020	C60552	C80552
7/16	.4375	7/16	5/8	2-1/2	5	0.000	C60553	C80553
7/16	.4375	7/16	5/8	2-1/2	5	0.020	C60554	C80554
7/16	.4375	7/16	1	3	5	0.000	C60555	C80555
7/16	.4375	7/16	1	3	5	0.020	C60556	C80556
7/16	.4375	7/16	2	4	5	0.000	C60557	C80557
1/2*	.5000	1/2	5/8	2-1/2	5	0.000	C60558	C80558
1/2*	.5000	1/2	5/8	2-1/2	5	0.030	C60559	C80559
1/2*	.5000	1/2	1	3	5	0.000	C60560	C80560
1/2*	.5000	1/2	1	3	5	0.030	C60561	C80561
1/2*	.5000	1/2	1	3	5	0.060	C60562	C80562
1/2*	.5000	1/2	1	3	5	0.090	C60563	C80563
1/2*	.5000	1/2	1	3	5	0.125	C60564	C80564
1/2*	.5000	1/2	1-1/4	3	5	0.000	C60565	C80565
1/2*	.5000	1/2	1-1/4	3	5	0.020	C60566	C80566
1/2*	.5000	1/2	1-1/4	3	5	0.030	C60567	C80567
1/2*	.5000	1/2	1-1/4	3	5	0.060	C60568	C80568
1/2*	.5000	1/2	1-1/4	3	5	0.090	C60569	C80569

* Weldon flats available on 1/2" and over, please specify when ordering and call customer service for pricing.

continued on next page

cutting diameter d₁		shank diameter d₂	length of cut l₂ (in)	overall length l₁ (in)	no. of flutes	corner radius	order number CEM-V2-5R	
fractional	decimal						bright	AP/MAX
1/2*	.5000	1/2	1-1/4	3	5	0.125	C60570	C80570
1/2*	.5000	1/2	2	4	5	0.000	C60571	C80571
1/2*	.5000	1/2	2	4	5	0.030	C60572	C80572
1/2*	.5000	1/2	2	4	5	0.060	C60573	C80573
1/2*	.5000	1/2	2	4	5	0.090	C60574	C80574
1/2*	.5000	1/2	2	4	5	0.125	C60575	C80575
5/8*	.6250	5/8	3/4	3	5	0.000	C60576	C80576
5/8*	.6250	5/8	3/4	3	5	0.030	C60577	C80577
5/8*	.6250	5/8	1-1/4	3-1/2	5	0.000	C60578	C80578
5/8*	.6250	5/8	1-1/4	3-1/2	5	0.030	C60579	C80579
5/8*	.6250	5/8	1-1/4	3-1/2	5	0.060	C60580	C80580
5/8*	.6250	5/8	1-1/4	3-1/2	5	0.090	C60581	C80581
5/8*	.6250	5/8	1-1/4	3-1/2	5	0.125	C60582	C80582
5/8*	.6250	5/8	2-1/4	5	5	0.000	C60583	C80583
5/8*	.6250	5/8	2-1/4	5	5	0.030	C60584	C80584
5/8*	.6250	5/8	2-1/4	5	5	0.060	C60585	C80585
5/8*	.6250	5/8	2-1/4	5	5	0.090	C60586	C80586
5/8*	.6250	5/8	2-1/4	5	5	0.125	C60587	C80587
3/4*	.7500	3/4	1	3	5	0.000	C60588	C80588
3/4*	.7500	3/4	1	3	5	0.015	C60511	C80511
3/4*	.7500	3/4	1	3	5	0.030	C60589	C80589
3/4*	.7500	3/4	1-1/2	4	5	0.000	C60590	C80590
3/4*	.7500	3/4	1-1/2	4	5	0.015	C60512	C80512
3/4*	.7500	3/4	1-1/2	4	5	0.030	C60591	C80591
3/4*	.7500	3/4	1-1/2	4	5	0.060	C60592	C80592
3/4*	.7500	3/4	1-1/2	4	5	0.090	C60593	C80593
3/4*	.7500	3/4	1-1/2	4	5	0.125	C60594	C80594
3/4*	.7500	3/4	2-1/4	5	5	0.000	C60595	C80595
3/4*	.7500	3/4	2-1/4	5	5	0.015	C60513	C80513
3/4*	.7500	3/4	2-1/4	5	5	0.030	C60596	C80596
3/4*	.7500	3/4	2-1/4	5	5	0.060	C60597	C80597
3/4*	.7500	3/4	2-1/4	5	5	0.090	C60598	C80598
3/4*	.7500	3/4	2-1/4	5	5	0.125	C60599	C80599
1*	1.0000	1	1-1/2	4	5	0.000	C60600	C80600
1*	1.0000	1	1-1/2	4	5	0.015	C60514	C80514
1*	1.0000	1	1-1/2	4	5	0.030	C60601	C80601
1*	1.0000	1	1-1/2	4	5	0.060	C60602	C80602
1*	1.0000	1	1-1/2	4	5	0.090	C60603	C80603
1*	1.0000	1	1-1/2	4	5	0.125	C60604	C80604
1*	1.0000	1	2-1/4	5	5	0.000	C60605	C80605
1*	1.0000	1	2-1/4	5	5	0.015	C60515	C80515
1*	1.0000	1	2-1/4	5	5	0.030	C60606	C80606
1*	1.0000	1	2-1/4	5	5	0.060	C60607	C80607
1*	1.0000	1	2-1/4	5	5	0.090	C60608	C80608
1*	1.0000	1	2-1/4	5	5	0.125	C60609	C80609
1*	1.0000	1	3	6	5	0.000	C60610	C80610
1*	1.0000	1	3	6	5	0.015	C60516	C80516
1*	1.0000	1	3	6	5	0.030	C60611	C80611
1*	1.0000	1	3	6	5	0.060	C60612	C80612
1*	1.0000	1	3	6	5	0.090	C60613	C80613
1*	1.0000	1	3	6	5	0.125	C60614	C80614

* Weldon flats available on 1/2" and over, please specify when ordering and call customer service for pricing.

Material Reference	Steel (HRC)				Stainless Steel			Cast Iron (HRC)		Aluminum and Non-Ferrous	Hi-Temp Alloy		Hardened Steel (HRC)
	Low Carbon		Alloy		Austenitic	Martensitic	PH	Gray	Nodular		Ni, Co, Fe Based Super Alloy	Titanium	
	Hardness	13-38	>38	16-38	> 38	300 Series	400 series		18-22	22-32			>45
AP/MAX	☆	◆	☆	◆	☆	☆	◆				☆	☆	◆

☆ = Best Performance ◆ = Acceptable

Carbide
Center Cutting

Styles: **CEM-V3-7R**

Note

Ideal for High Efficiency Machining (HEM)
Minimized chatter from unequal flute spacing.
*Weldon flats available 1/2" and larger.



Surface Treatment

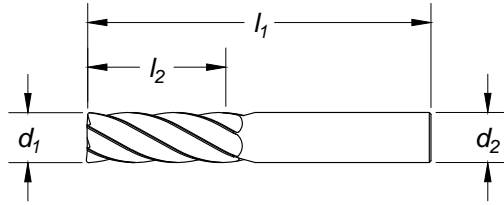

Feature

Use one tool for roughing and finishing operations.

cutting diameter d₁		shank diameter d₂	length of cut l₂ (in)	overall length l₁ (in)	no. of flutes	corner radius	order number
fractional	decimal						CEM-V3-7R
3/8	0.375	3/8	3/4	2-1/2	7	0.000	C76270
3/8	0.375	3/8	3/4	2-1/2	7	0.015	C76271
3/8	0.375	3/8	3/4	2-1/2	7	0.030	C76272
3/8	0.375	3/8	15/16	2-1/2	7	0.000	C76273
3/8	0.375	3/8	15/16	2-1/2	7	0.015	C76274
3/8	0.375	3/8	15/16	2-1/2	7	0.030	C76275
3/8	0.375	3/8	1-1/8	3	7	0.000	C76276
3/8	0.375	3/8	1-1/8	3	7	0.015	C76277
3/8	0.375	3/8	1-1/8	3	7	0.030	C76278
3/8	0.375	3/8	1-1/2	3-1/2	7	0.000	C76279
3/8	0.375	3/8	1-1/2	3-1/2	7	0.015	C76280
3/8	0.375	3/8	1-1/2	3-1/2	7	0.030	C76281
1/2	0.500	1/2	1	3	7	0.000	C76282
1/2	0.500	1/2	1	3	7	0.030	C76283
1/2	0.500	1/2	1	3	7	0.060	C76284
1/2	0.500	1/2	1	3	7	0.090	C76285
1/2	0.500	1/2	1-1/4	3	7	0.000	C76286
1/2	0.500	1/2	1-1/4	3	7	0.030	C76287
1/2	0.500	1/2	1-1/4	3	7	0.060	C76288
1/2	0.500	1/2	1-1/4	3	7	0.090	C76289
1/2	0.500	1/2	1-1/2	3-1/2	7	0.000	C76290
1/2	0.500	1/2	1-1/2	3-1/2	7	0.030	C76291
1/2	0.500	1/2	1-1/2	3-1/2	7	0.060	C76292
1/2	0.500	1/2	1-1/2	3-1/2	7	0.090	C76293
1/2	0.500	1/2	2	4	7	0.000	C76294
1/2	0.500	1/2	2	4	7	0.030	C76295
1/2	0.500	1/2	2	4	7	0.060	C76296
1/2	0.500	1/2	2	4	7	0.090	C76297
1/2	0.500	1/2	2-1/4	4	7	0.000	C76298
1/2	0.500	1/2	2-1/4	4	7	0.030	C76299
1/2	0.500	1/2	2-1/4	4	7	0.060	C76300
1/2	0.500	1/2	2-1/4	4	7	0.090	C76301
5/8	0.625	5/8	1-7/8	4	7	0.000	C76302
5/8	0.625	5/8	1-7/8	4	7	0.030	C76303
5/8	0.625	5/8	1-7/8	4	7	0.060	C76304
5/8	0.625	5/8	1-7/8	4	7	0.090	C76305
5/8	0.625	5/8	2-1/4	4	7	0.000	C76306
5/8	0.625	5/8	2-1/4	4	7	0.030	C76307
5/8	0.625	5/8	2-1/4	4	7	0.060	C76308
5/8	0.625	5/8	2-1/4	4	7	0.090	C76309
5/8	0.625	5/8	3	6	7	0.000	C76310
5/8	0.625	5/8	3	6	7	0.030	C76311
5/8	0.625	5/8	3	6	7	0.060	C76312

continued on next page

cutting diameter d₁		shank diameter d₂	length of cut l₂ (in)	overall length l₁ (in)	no. of flutes	corner radius	order number CEM-V3-7R AP/MAX
fractional	decimal						
3/4	0.750	3/4	1-1/2	4	7	0.000	C76313
3/4	0.750	3/4	1-1/2	4	7	0.030	C76314
3/4	0.750	3/4	1-1/2	4	7	0.060	C76315
3/4	0.750	3/4	1-1/2	4	7	0.125	C76316
3/4	0.750	3/4	1-7/8	4	7	0.000	C76317
3/4	0.750	3/4	1-7/8	4	7	0.030	C76318
3/4	0.750	3/4	1-7/8	4	7	0.060	C76319
3/4	0.750	3/4	1-7/8	4	7	0.090	C76320
3/4	0.750	3/4	1-7/8	4	7	0.125	C76321
3/4	0.750	3/4	2-1/4	5	7	0.000	C76322
3/4	0.750	3/4	2-1/4	5	7	0.030	C76323
3/4	0.750	3/4	2-1/4	5	7	0.060	C76324
3/4	0.750	3/4	2-1/4	5	7	0.090	C76325
3/4	0.750	3/4	2-1/4	5	7	0.125	C76326
3/4	0.750	3/4	2-5/8	5	7	0.000	C76327
3/4	0.750	3/4	2-5/8	5	7	0.030	C76328
3/4	0.750	3/4	2-5/8	5	7	0.060	C76329
3/4	0.750	3/4	2-5/8	5	7	0.090	C76330
3/4	0.750	3/4	2-5/8	5	7	0.125	C76331
3/4	0.750	3/4	3	6	7	0.000	C76332
3/4	0.750	3/4	3	6	7	0.030	C76333
3/4	0.750	3/4	3	6	7	0.060	C76334
3/4	0.750	3/4	3	6	7	0.125	C76335
1	1.000	1	3	6	7	0.000	C76341
1	1.000	1	3	6	7	0.030	C76342
1	1.000	1	3	6	7	0.060	C76343
1	1.000	1	3	6	7	0.125	C76344
1	1.000	1	3-1/2	6	7	0.000	C76345
1	1.000	1	3-1/2	6	7	0.030	C76346
1	0.375	1	3-1/2	6	7	0.060	C76347
1	0.375	1	3-1/2	6	7	0.125	C76348

Carbide
Center Cutting

Material Reference	Steel (HRC)				Stainless Steel			Cast Iron (HRC)		Aluminum and Non-Ferrous	Hi-Temp Alloy		Hardened Steel (HRC)
	Low Carbon		Alloy		Austenitic	Martensitic	PH	Gray	Nodular		Ni, Co, Fe Based Super Alloy	Titanium	
	Hardness	13-38	>38	16-38	> 38	300 Series	400 series		18-22	22-32			>45
AP/MAX	☆	◆	☆	◆	☆	☆	◆	◆	◆		☆	☆	◆

☆ = Best Performance ◆ = Acceptable

Note

Chip breaking geometry for improved High Efficiency Machining (HEM)

For slotting up to 1 x D.

Minimized chatter from unequal flute spacing.

*Weldon flats available 1/2" and larger.



Surface Treatment

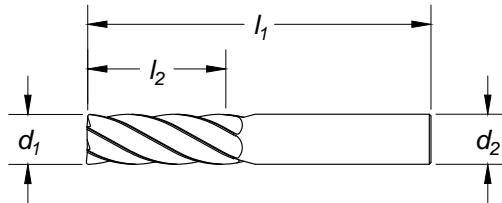

Feature

Use one tool for roughing and finishing operations.

cutting diameter d ₁		shank diameter d ₂	length of cut l ₂ (in)	overall length l ₁ (in)	no. of flutes	corner radius	order number
fractional	decimal						CEM-V3-7RCB AP/MAX
3/8	0.375	3/8	1-1/8	3	7	0.030	C76350
3/8	0.375	3/8	1-1/2	3-1/2	7	0.030	C76351
1/2	0.500	1/2	1-1/2	3-1/2	7	0.030	C76352
1/2	0.500	1/2	1-1/2	3-1/2	7	0.060	C76353
1/2	0.500	1/2	2	4	7	0.030	C76354
1/2	0.500	1/2	2	4	7	0.060	C76355
5/8	0.625	5/8	1-7/8	4	7	0.030	C76356
5/8	0.625	5/8	1-7/8	4	7	0.060	C76357
5/8	0.625	5/8	3	6	7	0.030	C76358
5/8	0.625	5/8	3	6	7	0.060	C76359
3/4	0.750	3/4	1-1/2	4	7	0.030	C76360
3/4	0.750	3/4	1-1/2	4	7	0.060	C76361
3/4	0.750	3/4	2-1/4	5	7	0.030	C76364
3/4	0.750	3/4	2-1/4	5	7	0.060	C76365
3/4	0.750	3/4	2-5/8	5	7	0.030	C76366
3/4	0.750	3/4	2-5/8	5	7	0.060	C76367
3/4	0.750	3/4	3	6	7	0.030	C76368
3/4	0.750	3/4	3	6	7	0.060	C76369
1	1.000	1	3	6	7	0.030	C76370
1	1.000	1	3	6	7	0.060	C76371

Carbide

Center Cutting

Material Reference	Steel (HRc)				Stainless Steel			Cast Iron (HRc)		Aluminum and Non-Ferrous	Hi-Temp Alloy		Hardened Steel (HRc)
	Low Carbon		Alloy		Austenitic	Martensitic	PH	Gray	Nodular		Ni, Co, Fe Based Super Alloy	Titanium	
	Hardness	13-38	>38	16-38	> 38	300 Series	400 series		18-22		22-32		
AP/MAX	☆	◆	☆	◆	☆	☆	◆	◆	◆		☆	☆	◆

☆ = Best Performance ◆ = Acceptable



Styles: **CEM-HPDE-5**

Steel Materials



Surface Treatment

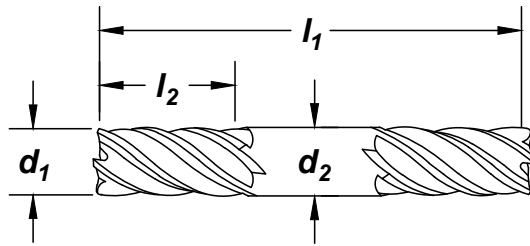

cutting diameter		shank diameter d₂	length of cut l₂ (in)	overall length l₁ (in)	no. of flutes	corner radius	order number	
d₁ fractional	decimal						CEM-HPDE-5 bright	TiAlN
1/8	.1250	1/8	1/4	1-1/2	5	0.000	C60100	C80100
3/16	.1875	3/16	5/16	2	5	0.000	C60101	C80101
1/4	.2500	1/4	3/8	2-1/2	5	0.000	C60102	C80102
5/16	.3125	5/16	7/16	2-1/2	5	0.000	C60103	C80103
3/8	.3750	3/8	1/2	2-1/2	5	0.000	C60104	C80104
7/16	.4375	7/16	9/16	3	5	0.000	C60105	C80105
1/2*	.5000	1/2	5/8	3	5	0.000	C60106	C80106

*Weldon shank; all others plain shank

Carbide

Center Cutting

Material Reference	Steel (HRC)				Stainless Steel			Cast Iron (HRC)		Aluminum and Non-Ferrous	Hi-Temp Alloy		Hardened Steel (HRC)
	Low Carbon		Alloy		Austenitic	Martensitic	PH	Gray	Nodular		Ni, Co, Fe Based Super Alloy	Titanium	
	Hardness	13-38	>38	16-38	> 38	300 Series	400 series		18-22	22-32			>45
Bright	◆	◆	◆	◆	◆	◆	◆				◆	☆	
TiAlN	☆	☆	☆	☆	☆	☆	◆						

☆ = Best Performance ◆ = Acceptable





Surface Treatment

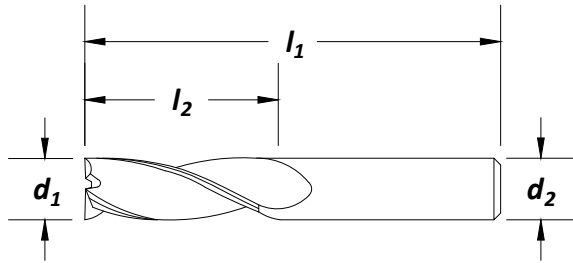

Carbide
Center Cutting

cutting diameter		shank diameter	length of cut	overall length	no. of flutes	corner radius	order number	
d_1	d_2	l_2 (in)	l_1 (in)	CEM-EMS-3				
fractional	decimal					bright	TiAlN	
1/8	.1250	1/8	1/4	1-1/2	3	0.010	C60365	C80365
1/8	.1250	1/8	1/2	1-1/2	3	0.010	C60366	C80366
5/32	.1562	3/16	5/16	1-1/2	3	0.010	C60367	C80367
5/32	.1562	3/16	9/16	2	3	0.010	C60368	C80368
3/16	.1875	3/16	5/16	2	3	0.010	C60369	C80369
3/16	.1875	3/16	5/8	2	3	0.010	C60370	C80370
7/32	.2188	1/4	1/2	2	3	0.020	C60371	C80371
7/32	.2188	1/4	3/4	2-1/2	3	0.020	C60372	C80372
1/4	.2500	1/4	3/8	2	3	0.020	C60373	C80373
1/4	.2500	1/4	3/4	2-1/2	3	0.020	C60374	C80374
9/32	.2812	5/16	7/16	2	3	0.020	C60375	C80375
9/32	.2812	5/16	13/16	2-1/2	3	0.020	C60376	C80376
5/16	.3125	5/16	7/16	2	3	0.020	C60377	C80377
5/16	.3125	5/16	13/16	2-1/2	3	0.020	C60378	C80378
11/32	.3438	3/8	1/2	2	3	0.020	C60379	C80379
11/32	.3438	3/8	7/8	2-1/2	3	0.020	C60380	C80380
3/8	.3750	3/8	1/2	2	3	0.020	C60381	C80381
3/8	.3750	3/8	7/8	2-1/2	3	0.020	C60382	C80382
13/32	.4062	7/16	9/16	2-1/2	3	0.020	C60383	C80383
13/32	.4062	7/16	1	2-1/2	3	0.020	C60384	C80384
7/16	.4375	7/16	9/16	2-1/2	3	0.020	C60385	C80385
7/16	.4375	7/16	1	2-1/2	3	0.020	C60386	C80386
15/32*	.4688	1/2	5/8	2-1/2	3	0.020	C60387	C80387
15/32*	.4688	1/2	1-1/4	3	3	0.020	C60388	C80388
1/2*	.5000	1/2	5/8	2-1/2	3	0.030	C60389	C80389
1/2*	.5000	1/2	1-1/4	3	3	0.030	C60390	C80390
5/8*	.6250	5/8	3/4	3	3	0.030	C60391	C80391
5/8*	.6250	5/8	1-5/8	4	3	0.030	C60392	C80392
3/4*	.7500	3/4	7/8	3	3	0.030	C60393	C80393
3/4*	.7500	3/4	1-5/8	4	3	0.030	C60394	C80394
1*	1.0000	1	1-1/8	3	3	0.030	C60395	C80395
1*	1.0000	1	2	4	3	0.030	C60396	C80396

*Weldon shank; all others plain shank

Material Reference	Steel (HRc)				Stainless Steel			Cast Iron (HRc)		Aluminum and Non-Ferrous	Hi-Temp Alloy		Hardened Steel (HRc)
	Low Carbon		Alloy		Austenitic	Martensitic	PH	Gray	Nodular		Ni, Co, Fe Based Super Alloy	Titanium	
	13-38	>38	16-38	> 38	300 Series	400 series		18-22	22-32				
TiAlN	☆	◆	☆	◆	☆	☆	◆					◆	

☆ = Best Performance ◆ = Acceptable

Solid Carbide

5 Flute CC

Helix 47°

Square End

Surface Treatment

Bright

TiAIN

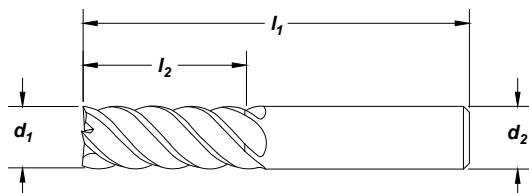

cutting diameter		shank diameter	length of cut	overall length	no. of flutes	corner radius	order number	
fractional	decimal						CEM-EMS-5	TiAIN
1/8	.1250	1/8	1/4	1-1/2	5	0.000	C60417	C80417
1/8	.1250	1/8	1/2	1-1/2	5	0.000	C60418	C80418
1/8	.1250	1/8	1/2	2	5	0.000	C60419	C80419
5/32	.1562	3/16	5/16	2	5	0.000	C60420	C80420
5/32	.1562	3/16	9/16	2	5	0.000	C60421	C80421
3/16	.1875	3/16	5/16	2	5	0.000	C60422	C80422
3/16	.1875	3/16	9/16	2	5	0.000	C60423	C80423
7/32	.2188	1/4	3/8	2	5	0.000	C60424	C80424
7/32	.2188	1/4	3/4	2-1/2	5	0.000	C60425	C80425
1/4	.2500	1/4	3/8	2	5	0.000	C60426	C80426
1/4	.2500	1/4	3/4	2-1/2	5	0.000	C60427	C80427
1/4	.2500	1/4	1-1/4	4	5	0.000	C60428	C80428
9/32	.2812	5/16	7/16	2	5	0.000	C60429	C80429
9/32	.2812	5/16	13/16	2-1/2	5	0.000	C60430	C80430
5/16	.3125	5/16	7/16	2	5	0.000	C60431	C80431
5/16	.3125	5/16	13/16	2-1/2	5	0.000	C60432	C80432
5/16	.3125	5/16	1-1/4	4	5	0.000	C60433	C80433
3/8	.3750	3/8	1/2	2	5	0.000	C60434	C80434
3/8	.3750	3/8	7/8	2-1/2	5	0.000	C60435	C80435
3/8	.3750	3/8	1-1/2	4	5	0.000	C60436	C80436
7/16	.4375	7/16	9/16	2-1/2	5	0.000	C60437	C80437
7/16	.4375	7/16	1	2-1/2	5	0.000	C60438	C80438
7/16	.4375	7/16	2	4	5	0.000	C60439	C80439
1/2*	.5000	1/2	5/8	2-1/2	5	0.000	C60440	C80440
1/2*	.5000	1/2	1-1/4	3	5	0.000	C60441	C80441
1/2*	.5000	1/2	2	4	5	0.000	C60442	C80442
9/16*	.5625	9/16	1-1/2	3 1/2	5	0.000	C60443	C80443
5/8*	.6250	5/8	3/4	3	5	0.000	C60444	C80444
5/8*	.6250	5/8	1-5/8	4	5	0.000	C60445	C80445
5/8*	.6250	5/8	2-1/2	5	5	0.000	C60446	C80446
3/4*	.7500	3/4	7/8	3	5	0.000	C60447	C80447
3/4*	.7500	3/4	1-5/8	4	5	0.000	C60448	C80448
3/4*	.7500	3/4	3 1/4	6	5	0.000	C60449	C80449
7/8*	.8750	7/8	2	4	5	0.000	C60450	C80450
1*	1.0000	1	1-1/8	3	5	0.000	C60451	C80451
1*	1.0000	1	2	4	5	0.000	C60452	C80452
1*	1.0000	1	3 1/4	6	5	0.000	C60453	C80453

*Weldon shank; all others plain shank

Material Reference	Steel (HRC)				Stainless Steel			Cast Iron (HRC)		Aluminum and Non-Ferrous	Hi-Temp Alloy		Hardened Steel (HRC)
	Low Carbon		Alloy		Austenitic	Martensitic	PH	Gray	Nodular		Ni, Co, Fe Based Super Alloy	Titanium	
	Hardness	13-38	>38	16-38	> 38	300 Series	400 series		18-22	22-32			>45
TiAIN	☆	◆	☆	◆	☆	☆	◆						◆

☆ = Best Performance ◆ = Acceptable

Carbide
Center Cutting



Surface Treatment

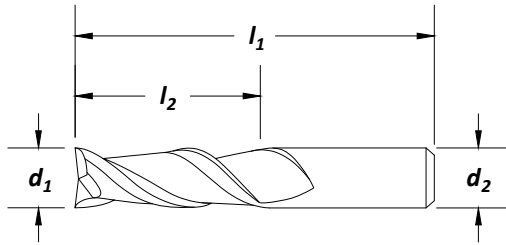

Carbide
Center Cutting

cutting diameter		shank diameter d_2	length of cut l_2 (in)	overall length l_1 (in)	no. of flutes	order number	
fractional	decimal					CEM-AM2	
1/8	.1250	1/8	1/4	1-1/2	2	bright C60477	ZrN C84000
1/8	.1250	1/8	3/8	1-1/2	2	C60478	C84001
3/16	.1875	3/16	5/16	2	2	C60479	C84002
3/16	.1875	3/16	9/16	2	2	C60480	C84003
1/4	.2500	1/4	3/8	2-1/2	2	C60481	C84004
1/4	.2500	1/4	3/4	2-1/2	2	C60482	C84005
1/4	.2500	1/4	1-1/4	3	2	C60483	C84006
5/16	.3125	5/16	7/16	2-1/2	2	C60484	C84007
5/16	.3125	5/16	13/16	2-1/2	2	C60485	C84008
5/16	.3125	5/16	1-1/4	3-3/4	2	C60486	C84009
5/16	.3125	5/16	2-1/8	4	2	C60487	C84010
3/8	.3750	3/8	1/2	2-1/2	2	C60488	C84011
3/8	.3750	3/8	1	2-1/2	2	C60489	C84012
3/8	.3750	3/8	1-1/2	4	2	C60490	C84013
3/8	.3750	3/8	2-1/2	6	2	C60491	C84014
7/16	.4375	7/16	9/16	2-1/2	2	C60492	C84015
7/16	.4375	7/16	1	2-1/2	2	C60493	C84016
7/16	.4375	7/16	2	4	2	C60494	C84017
1/2	.5000	1/2	5/8	3	2	C60495	C84018
1/2	.5000	1/2	1-1/4	3	2	C60496	C84019
1/2	.5000	1/2	2	4	2	C60497	C84020
1/2	.5000	1/2	3-1/8	6	2	C60498	C84021
5/8	.6250	5/8	3/4	3-1/2	2	C60499	C84022
5/8	.6250	5/8	1-5/8	4	2	C60500	C84023
5/8	.6250	5/8	2-1/2	5	2	C60501	C84024
5/8	.6250	5/8	3-3/4	6	2	C60502	C84025
3/4	.7500	3/4	1	4	2	C60503	C84026
3/4	.7500	3/4	1-5/8	4	2	C60504	C84027
3/4	.7500	3/4	3-1/4	6	2	C60505	C84028
1	1.0000	1	1-1/4	5	2	C60507	C84029
1	1.0000	1	2	5	2	C60508	C84030
1	1.0000	1	3-1/4	6	2	C60509	C84031
1	1.0000	1	4-1/8	7	2	C60510	C84032

Material Reference	Steel (HRC)				Stainless Steel			Cast Iron (HRc)		Aluminum and Non-Ferrous	Hi-Temp Alloy		Hardened Steel (HRc)
	Low Carbon		Alloy		Austenitic	Martensitic	PH	Gray	Nodular		Ni, Co, Fe Based Super Alloy	Titanium	
	Hardness	13-38	>38	16-38	> 38	300 Series	400 series		18-22	22-32			>45
Bright										◆			
ZrN										☆			

☆ = Best Performance ◆ = Acceptable



Style: **CEM-AM3**

Aluminum Materials



Surface Treatment

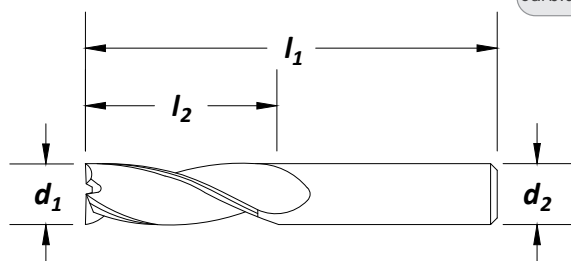

cutting diameter d₁		shank diameter d₂	length of cut l₂ (in)	overall length l₁ (in)	no. of flutes	corner radius	order number CEM-AM3	
fractional	decimal						bright	ZrN
1/8	.1250	1/8	1/4	1-1/2	3	.000	C60616	C72340
1/8	.1250	1/8	3/8	1-1/2	3	.000	C60617	C72341
1/8	.1250	1/8	3/8	1-1/2	3	.015	C72375	C84150
3/16	.1875	3/16	5/16	2	3	.000	C60618	C72342
3/16	.1875	3/16	9/16	2	3	.000	C60619	C72343
3/16	.1875	3/16	9/16	2	3	.015	C72376	C84151
1/4	.2500	1/4	3/8	2	3	.000	C60620	C72344
1/4	.2500	1/4	3/8	2	3	.015	C72377	C84152
1/4	.2500	1/4	3/8	2	3	.030	C72378	C84153
1/4	.2500	1/4	3/4	2-1/2	3	.000	C60621	C72345
1/4	.2500	1/4	3/4	2-1/2	3	.015	C72379	C84154
1/4	.2500	1/4	3/4	2-1/2	3	.030	C72380	C84155
1/4	.2500	1/4	1-1/4	3	3	.000	C60622	C72346
1/4	.2500	1/4	1-1/4	3	3	.015	C72381	C84156
1/4	.2500	1/4	1-1/4	3	3	.030	C72382	C84157
5/16	.3125	5/16	7/16	2	3	.000	C60623	C72347
5/16	.3125	5/16	5/8	2-1/2	3	.000	C60624	C72348
5/16	.3125	5/16	1-1/4	3-3/4	3	.000	C60625	C72349
5/16	.3125	5/16	1-1/4	3-3/4	3	.015	C72383	C84158
5/16	.3125	5/16	1-1/4	3-3/4	3	.030	C72384	C84159
5/16	.3125	5/16	2-1/8	4	3	.000	C60626	C72350
3/8	.3750	3/8	1/2	2	3	.000	C60627	C72351
3/8	.3750	3/8	1/2	2	3	.015	C72385	C84160
3/8	.3750	3/8	1	2-1/2	3	.000	C60628	C72352
3/8	.3750	3/8	1	2-1/2	3	.015	C72386	C84161
3/8	.3750	3/8	1	2-1/2	3	.030	C72387	C84162
3/8	.3750	3/8	1	2-1/2	3	.060	C72388	C84163
3/8	.3750	3/8	1-1/2	3-1/2	3	.000	C60629	C72353
3/8	.3750	3/8	1-1/2	3-1/2	3	.015	C72389	C84164
3/8	.3750	3/8	1-1/2	3-1/2	3	.030	C72390	C84165
3/8	.3750	3/8	1-1/2	3-1/2	3	.060	C72391	C84166
3/8	.3750	3/8	2-1/2	6	3	.000	C60630	C72354
7/16	.4375	7/16	9/16	2-1/2	3	.000	C60631	C72355
7/16	.4375	7/16	9/16	2-1/2	3	.015	C72392	C84167
7/16	.4375	7/16	9/16	2-1/2	3	.030	C72393	C84168
7/16	.4375	7/16	9/16	2-1/2	3	.060	C72394	C84169
7/16	.4375	7/16	1	2-1/2	3	.000	C60632	C72356
7/16	.4375	7/16	2	4	3	.000	C60633	C72357

continued on next page

Material Reference	Steel (HRC)		Stainless Steel			Cast Iron (HRC)		Aluminum and Non-Ferrous	Hi-Temp Alloy		Hardened Steel (HRC)
	Low Carbon	Alloy	Austenitic	Martensitic	PH	Gray	Nodular		Ni, Co, Fe Based Super Alloy	Titanium	
	Hardness	13-38	>38	16-38	> 38	300 Series	400 series				
Bright									◆		
ZrN									☆		

☆ = Best Performance ◆ = Acceptable





cutting diameter		shank diameter d ₂	length of cut l ₂ (in)	overall length l ₁ (in)	no. of flutes	corner radius	order number	
d ₁ fractional	d ₁ decimal						CEM-AM3	
						bright	ZrN	
1/2	.5000	1/2	5/8	2-1/2	3	.000	C60634	C72358
1/2	.5000	1/2	5/8	2-1/2	3	.060	C72395	C84170
1/2	.5000	1/2	1-1/4	3	3	.000	C60635	C72359
1/2	.5000	1/2	1-1/4	3	3	.015	C72396	C84171
1/2	.5000	1/2	1-1/4	3	3	.030	C72397	C84172
1/2	.5000	1/2	1-1/4	3	3	.060	C72398	C84173
1/2	.5000	1/2	1-1/4	3	3	.125	C72399	C84174
1/2	.5000	1/2	2	4	3	.000	C60636	C72360
1/2	.5000	1/2	2	4	3	.015	C72400	C84175
1/2	.5000	1/2	2	4	3	.030	C72401	C84176
1/2	.5000	1/2	2	4	3	.060	C72402	C84177
1/2	.5000	1/2	2	4	3	.125	C72403	C84178
1/2	.5000	1/2	2-1/2	4	3	.000	C72404	C84179
1/2	.5000	1/2	2-1/2	4	3	.015	C72405	C84180
1/2	.5000	1/2	2-1/2	4	3	.030	C72406	C84181
1/2	.5000	1/2	2-1/2	4	3	.060	C72407	C84182
1/2	.5000	1/2	2-1/2	4	3	.125	C72408	C84183
1/2	.5000	1/2	3-1/8	6	3	.000	C60637	C72361
1/2	.5000	1/2	3-1/8	6	3	.030	C72409	C84184
5/8	.6250	5/8	3/4	3	3	.000	C60638	C72362
5/8	.6250	5/8	3/4	3	3	.030	C72410	C84185
5/8	.6250	5/8	1-5/8	4	3	.000	C60639	C72363
5/8	.6250	5/8	1-5/8	4	3	.030	C72411	C84186
5/8	.6250	5/8	1-5/8	4	3	.125	C72412	C84187
5/8	.6250	5/8	2-1/2	5	3	.000	C60640	C72364
5/8	.6250	5/8	2-1/2	5	3	.030	C72413	C84188
5/8	.6250	5/8	2-1/2	5	3	.125	C72414	C84189
5/8	.6250	5/8	3-3/4	6	3	.000	C60641	C72365
5/8	.6250	5/8	3-3/4	6	3	.030	C72415	C84190
3/4	.7500	3/4	1	3	3	.000	C60642	C72366
3/4	.7500	3/4	1	3	3	.030	C72416	C84191
3/4	.7500	3/4	1	3	3	.060	C72417	C84192
3/4	.7500	3/4	1	3	3	.125	C72418	C84193
3/4	.7500	3/4	1-5/8	4	3	.000	C60643	C72367
3/4	.7500	3/4	1-5/8	4	3	.030	C72419	C84194
3/4	.7500	3/4	1-5/8	4	3	.060	C72420	C84195
3/4	.7500	3/4	1-5/8	4	3	.125	C72421	C84196
3/4	.7500	3/4	2-1/2	5	3	.000	C72422	C84197
3/4	.7500	3/4	2-1/2	5	3	.030	C72423	C84198
3/4	.7500	3/4	2-1/2	5	3	.060	C72424	C84199
3/4	.7500	3/4	2-1/2	5	3	.125	C72425	C84200
3/4	.7500	3/4	3-1/4	6	3	.000	C60644	C72368
3/4	.7500	3/4	3-1/4	6	3	.030	C72426	C84201
3/4	.7500	3/4	3-1/4	6	3	.125	C72427	C84202
1	1.0000	1	1-1/2	4	3	.000	C60645	C72369
1	1.0000	1	1-1/2	4	3	.030	C72428	C84203
1	1.0000	1	2	5	3	.000	C60646	C72370
1	1.0000	1	2	5	3	.030	C72429	C84204
1	1.0000	1	2-1/2	5	3	.000	C72430	C84205
1	1.0000	1	2-1/2	5	3	.030	C72431	C84206
1	1.0000	1	3-1/2	6	3	.000	C60647	C72371
1	1.0000	1	3-1/2	6	3	.030	C72432	C84207

Carbide

Center Cutting

Material Reference	Steel (HRc)				Stainless Steel			Cast Iron (HRc)		Aluminum and Non-Ferrous	Hi-Temp Alloy		Hardened Steel (HRc)
	Low Carbon		Alloy		Austenitic	Martensitic	PH	Gray	Nodular		Ni, Co, Fe Based Super Alloy	Titanium	
	Hardness	13-38	>38	16-38	> 38	300 Series	400 series		18-22	22-32			>45
Bright											◆		
ZrN											☆		

☆ = Best Performance ◆ = Acceptable



Note
Has a Weldon shank

Solid Carbide

4 Flute CC

Square End

Surface Treatment

Bright

TiAIN

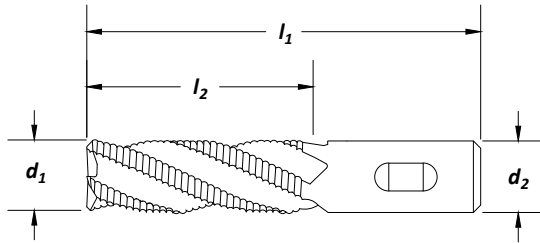

cutting diameter		shank diameter d₂	length of cut l₂ (in)	overall length l₁ (in)	no. of flutes	corner radius	order number	
d₁ fractional	decimal						CEM-RS	
						bright	TiAIN	
1/4	.2500	1/4	1/4	2	4	0.000	C60148	C80148
1/4	.2500	1/4	3/4	2-1/2	4	0.000	C60149	C80149
3/8	.3750	3/8	3/8	2	4	0.000	C60150	C80150
3/8	.3750	3/8	7/8	2-1/2	4	0.000	C60151	C80151
1/2	.5000	1/2	1/2	2-1/2	4	0.000	C60152	C80152
1/2	.5000	1/2	1	3	4	0.000	C60153	C80153
5/8	.6250	5/8	3/4	3	4	0.000	C60154	C80154
5/8	.6250	5/8	1-1/4	3 1/2	4	0.000	C60155	C80155
3/4	.7500	3/4	7/8	3 1/2	4	0.000	C60156	C80156
3/4	.7500	3/4	1-1/2	4	4	0.000	C60157	C80157
1	1.0000	1	1	3 1/2	4	0.000	C60158	C80158
1	1.0000	1	1-1/2	4	4	0.000	C60159	C80159

Carbide

Center Cutting

Material Reference	Steel (HRC)				Stainless Steel			Cast Iron (HRC)		Aluminum and Non-Ferrous	Hi-Temp Alloy		Hardened Steel (HRC)
	Low Carbon		Alloy		Austenitic	Martensitic	PH	Gray	Nodular		Ni, Co, Fe Based Super Alloy	Titanium	
	Hardness	13-38	>38	16-38	> 38	300 Series	400 series		18-22	22-32			>45
TiAIN	◆		◆		☆	☆	◆						☆

☆ = Best Performance ◆ = Acceptable

Note
Has a Weldon shank



Surface Treatment

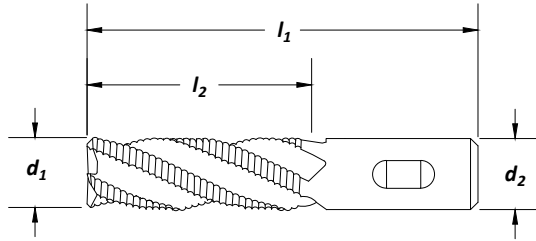

cutting diameter		shank diameter	length of cut	overall length	no. of flutes	order number	
d_1	d_2					CEM-RA	
fractional	decimal		l_2 (in)	l_1 (in)		bright	TiCN
1/4	.2500	1/4	3/8	2	3	C60455	C70455
1/4	.2500	1/4	3/4	2-1/2	3	C60456	C70456
3/8	.3750	3/8	1/2	2	3	C60457	C70457
3/8	.3750	3/8	7/8	2-1/2	3	C60458	C70458
1/2	.5000	1/2	5/8	2-1/2	3	C60459	C70459
1/2	.5000	1/2	1	3	3	C60460	C70460
1/2	.5000	1/2	2	4-1/2	3	C60461	C70461
5/8	.6250	5/8	3/4	3	3	C60462	C70462
5/8	.6250	5/8	1-1/4	3-1/2	3	C60463	C70463
5/8	.6250	5/8	2-1/4	5	3	C60464	C70464
3/4	.7500	3/4	1	3-1/2	3	C60465	C70465
3/4	.7500	3/4	1-1/2	4	3	C60466	C70466
3/4	.7500	3/4	2-1/4	5	3	C60467	C70467
1	1.0000	1	1-1/8	3-1/2	3	C60468	C70468
1	1.0000	1	1-1/2	4	3	C60469	C70469
1	1.0000	1	2-1/4	5	3	C60470	C70470

Carbide

Center Cutting

Material Reference	Steel (HRC)				Stainless Steel			Cast Iron (HRC)		Aluminum and Non-Ferrous	Hi-Temp Alloy		Hardened Steel (HRC)
	Low Carbon		Alloy		Austenitic	Martensitic	PH	Gray	Nodular		Ni, Co, Fe Based Super Alloy	Titanium	
	13-38	>38	16-38	> 38	300 Series	400 series		18-22	22-32				
Hardness	13-38	>38	16-38	> 38	300 Series	400 series	PH	18-22	22-32				
TiCN										☆			

☆ = Best Performance ◆ = Acceptable



Style: **CEM-DE2**

General Purpose



Surface Treatment

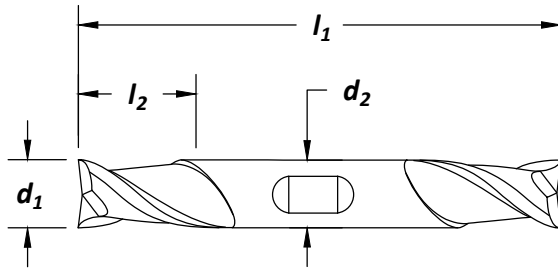

cutting diameter d₁		shank diameter d₂	length of cut l₂ (in)	overall length l₁ (in)	no. of flutes	order number CEM-DE2	
fractional	decimal					bright	TiAlN
1/16	.0625	1/8	1/8	1-1/2	2	C60169	C80169
3/32	.0938	1/8	3/16	1-1/2	2	C60170	C80170
1/8	.1250	1/8	1/4	1-1/2	2	C60171	C80171
1/8*	.1250	3/8	3/8	3	2	C60172	C80172
5/32	.1562	3/16	5/16	2	2	C60173	C80173
5/32*	.1562	3/8	7/16	3	2	C60174	C80174
3/16	.1875	3/16	3/8	2	2	C60175	C80175
3/16*	.1875	3/8	1/2	3	2	C60176	C80176
7/32*	.2188	3/8	9/16	3 1/2	2	C60177	C80177
1/4	.2500	1/4	1/2	2-1/2	2	C60178	C80178
1/4*	.2500	3/8	5/8	3 1/2	2	C60179	C80179
9/32*	.2812	3/8	11/16	3 1/2	2	C60180	C80180
5/16*	.3125	3/8	3/4	3 1/2	2	C60181	C80181
3/8	.3750	3/8	9/16	3	2	C60182	C80182
3/8*	.3750	3/8	3/4	3 1/2	2	C60183	C80183
7/16*	.4375	1/2	7/8	4	2	C60184	C80184
1/2	.5000	1/2	5/8	3	2	C60185	C80185
1/2*	.5000	1/2	1	4	2	C60186	C80186

*Weldon shank; all others plain shank

Carbide

Center Cutting

Material Reference	Steel (HRC)		Stainless Steel			Cast Iron (HRC)		Aluminum and Non-Ferrous	Hi-Temp Alloy		Hardened Steel (HRC)
	Low Carbon	Alloy	Austenitic	Martensitic	PH	Gray	Nodular		Ni, Co, Fe Based Super Alloy	Titanium	
Hardness	13-38	>38	16-38	> 38	300 Series	400 series					>45
Bright	◆		◆				◆	◆	☆		
TiAlN	☆		☆		◆	◆	☆	☆			

☆ = Best Performance ◆ = Acceptable





Surface Treatment

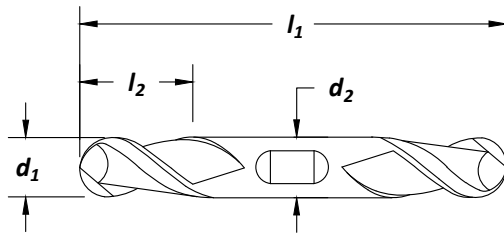

cutting diameter d ₁		shank diameter d ₂	length of cut l ₂ (in)	overall length l ₁ (in)	no. of flutes	order number CEM-DE2B	
fractional	decimal					bright	TiAlN
1/16	.0625	1/8	1/8	1-1/2	2	C60205	C80205
3/32	.0938	1/8	3/16	1-1/2	2	C60206	C80206
1/8*	.1250	3/8	3/8	3	2	C60207	C80207
5/32*	.1562	3/8	7/16	3	2	C60208	C80208
3/16*	.1875	3/8	1/2	3	2	C60209	C80209
7/32*	.2188	3/8	9/16	3 1/2	2	C60210	C80210
1/4*	.2500	3/8	5/8	3 1/2	2	C60211	C80211
9/32*	.2812	3/8	11/16	3 1/2	2	C60212	C80212
5/16*	.3125	3/8	3/4	3 1/2	2	C60213	C80213
3/8*	.3750	3/8	3/4	3 1/2	2	C60214	C80214
7/16*	.4375	1/2	7/8	4	2	C60215	C80215
1/2*	.5000	1/2	1	4	2	C60216	C80216

*Weldon shank; all others plain shank

Carbide

Center Cutting

Material Reference	Steel (HRC)				Stainless Steel			Cast Iron (HRC)		Aluminum and Non-Ferrous	Hi-Temp Alloy		Hardened Steel (HRC)
	Low Carbon		Alloy		Austenitic	Martensitic	PH	Gray	Nodular		Ni, Co, Fe Based Super Alloy	Titanium	
	Hardness	13-38	>38	16-38	> 38	300 Series	400 series		18-22	22-32			>45
Bright	◆		◆					◆	◆	☆			
TiAlN	☆		☆		◆	◆		☆	☆				

☆ = Best Performance ◆ = Acceptable



Style: CEM-DE4

General Purpose



Surface Treatment

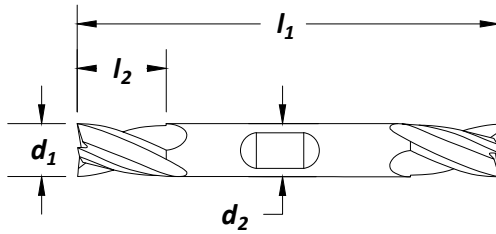

cutting diameter		shank diameter	length of cut	overall length	no. of flutes	order number	
d ₁		d ₂	l ₂ (in)	l ₁ (in)		CEM-DE4	
fractional	decimal					bright	TiAlN
1/16	.0625	1/8	1/8	1-1/2	4	C60269	C80269
3/32	.0938	1/8	3/16	1-1/2	4	C60270	C80270
1/8	.1250	1/8	1/4	1-1/2	4	C60271	C80271
1/8	.1250	3/16	1/4	2	4	C60272	C80272
1/8*	.1250	3/8	7/16	3	4	C60273	C80273
5/32	.1562	3/16	5/16	2	4	C60274	C80274
5/32*	.1562	3/8	7/16	3	4	C60275	C80275
3/16	.1875	3/16	3/8	2	4	C60276	C80276
3/16*	.1875	3/8	1/2	3	4	C60277	C80277
7/32*	.2188	3/8	9/16	3 1/2	4	C60278	C80278
1/4	.2500	1/4	1/2	2-1/2	4	C60279	C80279
1/4*	.2500	3/8	5/8	3 1/2	4	C60280	C80280
9/32*	.2812	3/8	11/16	3 1/2	4	C60281	C80281
5/16	.3125	5/16	1/2	2-1/2	4	C60282	C80282
5/16*	.3125	3/8	3/4	3 1/2	4	C60283	C80283
3/8	.3750	3/8	9/16	3	4	C60284	C80284
3/8*	.3750	3/8	3/4	3 1/2	4	C60285	C80285
7/16*	.4375	1/2	7/8	4	4	C60286	C80286
1/2	.5000	1/2	5/8	3	4	C60287	C80287
1/2*	.5000	1/2	1	4	4	C60288	C80288

*Weldon shank; all others plain shank

Carbide

Center Cutting

Material Reference	Steel (HRC)		Stainless Steel			Cast Iron (HRC)		Aluminum and Non-Ferrous	Hi-Temp Alloy		Hardened Steel (HRC)	
	Low Carbon	Alloy	Austenitic	Martensitic	PH	Gray	Nodular		Ni, Co, Fe Based Super Alloy	Titanium		
	Hardness	13-38	>38	16-38	> 38	300 Series	400 series					>45
Bright	◆		◆					◆	◆	☆		
TiAlN	☆		☆		◆	◆		☆	☆			◆

☆ = Best Performance ◆ = Acceptable



General Purpose

Style: **CEM-DE4B**



Surface Treatment

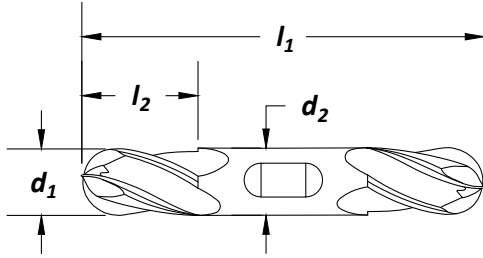

cutting diameter		shank diameter d₂	length of cut l₂ (in)	overall length l₁ (in)	no. of flutes	order number	
d₁ fractional	decimal					CEM-DE4B bright TiAlN	
1/16	.0625	1/8	1/8	1-1/2	4	C60305	C80305
3/32	.0938	1/8	3/16	1-1/2	4	C60306	C80306
1/8*	.1250	3/8	3/8	3	4	C60307	C80307
5/32*	.1562	3/8	7/16	3	4	C60308	C80308
3/16*	.1875	3/8	1/2	3	4	C60309	C80309
7/32*	.2188	3/8	9/16	3 1/2	4	C60310	C80310
1/4*	.2500	3/8	5/8	3 1/2	4	C60311	C80311
9/32*	.2812	3/8	11/16	3 1/2	4	C60312	C80312
5/16*	.3125	3/8	3/4	3 1/2	4	C60313	C80313
3/8*	.3750	3/8	3/4	3 1/2	4	C60314	C80314
7/16*	.4375	1/2	7/8	4	4	C60315	C80315
1/2*	.5000	1/2	1	4	4	C60316	C80316

*Weldon shank; all others plain shank

Carbide

Center Cutting

Material Reference	Steel (HRC)		Stainless Steel			Cast Iron (HRC)		Aluminum and Non-Ferrous	Hi-Temp Alloy		Hardened Steel (HRC)
	Low Carbon	Alloy	Austenitic	Martensitic	PH	Gray	Nodular		Ni, Co, Fe Based Super Alloy	Titanium	
Hardness	13-38	>38	16-38	> 38		300 Series	400 series				>45
Bright	◆		◆					◆	◆	☆	
TiAlN	☆		☆			◆	◆	☆	☆		

☆ = Best Performance ◆ = Acceptable

Note

General purpose applications.
30° right hand spiral-right hand cut
Diameter tolerance: $\pm 0.0005''$

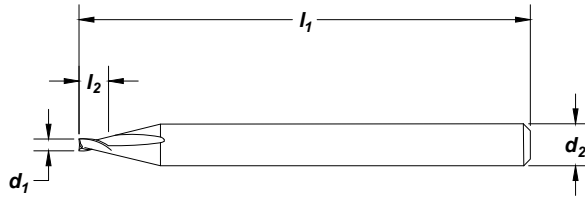
Surface Treatment

cutting diameter d₁	shank diameter d₂	length of cut l₂ (in)	overall length l₁ (in)	description	order number	
					CMCE-2 Bright	CMCE-2AL AlCrN
0.005	1/8	0.0150	1-1/2	0.005 x 1/8 x 1-1/2	C76001	—
0.006	1/8	0.0180	1-1/2	0.006 x 1/8 x 1-1/2	C76002	—
0.007	1/8	0.0210	1-1/2	0.007 x 1/8 x 1-1/2	C76003	—
0.008	1/8	0.0240	1-1/2	0.008 x 1/8 x 1-1/2	C76004	—
0.009	1/8	0.0270	1-1/2	0.009 x 1/8 x 1-1/2	C76005	—
0.010	1/8	0.0300	1-1/2	0.010 x 1/8 x 1-1/2	C76006	—
0.011	1/8	0.0330	1-1/2	0.011 x 1/8 x 1-1/2	C76007	—
0.012	1/8	0.0360	1-1/2	0.012 x 1/8 x 1-1/2	C76008	—
0.013	1/8	0.0390	1-1/2	0.013 x 1/8 x 1-1/2	C76009	—
0.014	1/8	0.0420	1-1/2	0.014 x 1/8 x 1-1/2	C76010	—
0.015	1/8	0.0450	1-1/2	0.015 x 1/8 x 1-1/2	C76011	—
0.0156	1/8	0.0468	1-1/2	0.0156 x 1/8 x 1-1/2	C76012	—
0.018	1/8	0.0540	1-1/2	0.018 x 1/8 x 1-1/2	C76013	—
0.020	1/8	0.0600	1-1/2	0.020 x 1/8 x 1-1/2	C76014	—
0.023	1/8	0.0690	1-1/2	0.023 x 1/8 x 1-1/2	C76015	—
0.024	1/8	0.0720	1-1/2	0.024 x 1/8 x 1-1/2	C76016	—
0.025	1/8	0.0750	1-1/2	0.025 x 1/8 x 1-1/2	C76017	—
0.026	1/8	0.0780	1-1/2	0.026 x 1/8 x 1-1/2	C76018	—
0.029	1/8	0.0870	1-1/2	0.029 x 1/8 x 1-1/2	C76019	—
0.030	1/8	0.0900	1-1/2	0.030 x 1/8 x 1-1/2	C76020	—
0.031	1/8	0.0930	1-1/2	0.031 x 1/8 x 1-1/2	C76021	C76200
0.033	1/8	0.0990	1-1/2	0.033 x 1/8 x 1-1/2	C76022	C76201
0.035	1/8	0.1050	1-1/2	0.035 x 1/8 x 1-1/2	C76023	C76202
0.040	1/8	0.1200	1-1/2	0.040 x 1/8 x 1-1/2	C76024	C76203
0.045	1/8	0.1350	1-1/2	0.045 x 1/8 x 1-1/2	C76025	C76204
0.047	1/8	0.1410	1-1/2	0.047 x 1/8 x 1-1/2	C76026	C76205
0.050	1/8	0.1500	1-1/2	0.050 x 1/8 x 1-1/2	C76027	C76206
0.055	1/8	0.1650	1-1/2	0.055 x 1/8 x 1-1/2	C76028	C76207
0.060	1/8	0.1800	1-1/2	0.060 x 1/8 x 1-1/2	C76029	C76208
0.062	1/8	0.1875	1-1/2	0.062 x 1/8 x 1-1/2	C76030	C76209
0.064	1/8	0.1920	1-1/2	0.064 x 1/8 x 1-1/2	C76031	C76210
0.065	1/8	0.1950	1-1/2	0.065 x 1/8 x 1-1/2	C76032	C76211
0.070	1/8	0.2100	1-1/2	0.070 x 1/8 x 1-1/2	C76033	C76212

continued on next page

Material Reference	Steel (HRC)		Stainless Steel			Cast Iron (HRC)		Aluminum and Non-Ferrous	Hi-Temp Alloy		Hardened Steel (HRC)
	Low Carbon	Alloy	Austenitic	Martensitic	PH	Gray	Nodular		Ni, Co, Fe Based Super Alloy	Titanium	
	Hardness	13-38	>38	16-38	> 38	300 Series	400 series		18-22	22-32	
Bright	◆		◆		◆	◆		◆	◆		
AlCrN	☆	◆	☆	◆	☆	☆	◆	☆	☆	◆	◆

☆ = Best Performance ◆ = Acceptable

Style: **CMCE-2 / CMCE-2AL** (continued)

cutting diameter d₁	shank diameter d₂	length of cut l₂ (in)	overall length l₁ (in)	description	order number	
					CMCE-2 Bright	CMCE-2AL AlCrN
0.075	1/8	0.2250	1-1/2	0.075 x 1/8 x 1-1/2	C76034	C76213
0.078	1/8	0.2243	1-1/2	0.078 x 1/8 x 1-1/2	C76035	C76214
0.080	1/8	0.2400	1-1/2	0.080 x 1/8 x 1-1/2	C76036	C76215
0.085	1/8	0.2550	1-1/2	0.085 x 1/8 x 1-1/2	C76037	C76216
0.090	1/8	0.2700	1-1/2	0.090 x 1/8 x 1-1/2	C76038	C76217
0.093	1/8	0.2814	1-1/2	0.093 x 1/8 x 1-1/2	C76039	C76218
0.095	1/8	0.2850	1-1/2	0.095 x 1/8 x 1-1/2	C76040	C76219
0.100	1/8	0.3000	1-1/2	0.100 x 1/8 x 1-1/2	C76041	C76220
0.103	1/8	0.3090	1-1/2	0.103 x 1/8 x 1-1/2	C76042	C76221
0.120	1/8	0.3600	1-1/2	0.120 x 1/8 x 1-1/2	C76043	C76222

Miniature Metric

Style: **CMCE-2 / CMCE-2AL**

cutting diameter d₁		shank diameter d₂	length of cut l₂ (in)	overall length l₁ (in)	description	order number	
(mm)	(in)					CMCE-2 Bright	CMCE-2AL AlCrN
.5mm	0.0197	1/8	0.0591	1-1/2	.5mm x 1/8 x 1-1/2	C76044	—
1.0mm	0.0394	1/8	0.1182	1-1/2	1.0mm x 1/8 x 1-1/2	C76045	C76223
1.25mm	0.0492	1/8	0.1476	1-1/2	1.25mm x 1/8 x 1-1/2	C76046	C76224
1.5mm	0.0591	1/8	0.1773	1-1/2	1.5mm x 1/8 x 1-1/2	C76047	C76225
1.6mm	0.0630	1/8	0.1890	1-1/2	1.6mm x 1/8 x 1-1/2	C76048	C76226
1.8mm	0.0709	1/8	0.2127	1-1/2	1.8mm x 1/8 x 1-1/2	C76049	C76227
2.0mm	0.0787	1/8	0.2361	1-1/2	2.0mm x 1/8 x 1-1/2	C76050	C76228
2.2mm	0.0866	1/8	0.2598	1-1/2	2.2mm x 1/8 x 1-1/2	C76051	C76229
2.5mm	0.0984	1/8	0.2952	1-1/2	2.5mm x 1/8 x 1-1/2	C76052	C76230
2.8mm	0.1102	1/8	0.3306	1-1/2	2.8mm x 1/8 x 1-1/2	C76053	C76231
3.0mm	0.1181	1/8	0.3543	1-1/2	3.0mm x 1/8 x 1-1/2	C76054	C76232
3.5mm	0.1378	3/16	0.4134	2	3.5mm x 3/16 x 2	C76055	C76233
4.5mm	0.1772	3/16	0.5316	2	4.5mm x 3/16 x 2	C76056	C76234

Carbide

Center Cutting

Material Reference	Steel (HRC)				Stainless Steel			Cast Iron (HRc)		Aluminum and Non-Ferrous	Hi-Temp Alloy		Hardened Steel (HRC)
	Low Carbon		Alloy		Austenitic	Martensitic	PH	Gray	Nodular		Ni, Co, Fe Based Super Alloy	Titanium	
Hardness	13-38	>38	16-38	> 38	300 Series	400 series		18-22	22-32				>45
Bright	◆		◆		◆	◆		◆	◆				
AlCrN	☆	◆	☆	◆	☆	☆	◆	☆	☆	☆	◆	◆	◆

☆ = Best Performance ◆ = Acceptable



Style: **CEM-SE2**

General Purpose

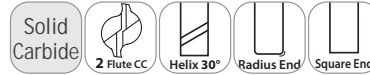

Surface Treatment

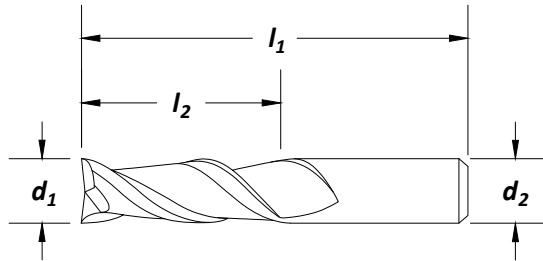

cutting diameter		shank diameter	length of cut	overall length	no. of flutes	corner radius	order number	
d₁		d₂	l₂ (in)	l₁ (in)			CEM-SE2	
fractional	decimal						bright	TiAlN
1/32	.0312	1/8	1/8	1-1/2	2	0.000	C61001	C81001
3/64	.0469	1/8	1/8	1-1/2	2	0.000	C61002	C81002
1/16	.0625	1/8	1/8	1-1/2	2	0.000	C61003	C81003
1/16	.0625	1/8	3/16	1-1/2	2	0.000	C61004	C81004
5/64	.0781	1/8	3/16	1-1/2	2	0.000	C61005	C81005
3/32	.0938	1/8	3/16	1-1/2	2	0.000	C61006	C81006
3/32	.0938	1/8	3/8	1-1/2	2	0.000	C61007	C81007
7/64	.1094	1/8	3/8	1-1/2	2	0.000	C61008	C81008
1/8	.1250	1/8	1/4	1-1/2	2	0.000	C61009	C81009
1/8	.1250	1/8	1/2	1-1/2	2	0.000	C61010	C81010
1/8	.1250	1/8	1/2	1-1/2	2	0.010	C61011	C81011
1/8	.1250	1/8	3/4	2-1/4	2	0.000	C61012	C81012
1/8	.1250	1/8	1	3	2	0.000	C61013	C81013
9/64	.1406	3/16	9/16	2	2	0.000	C61014	C81014
5/32	.1562	3/16	9/16	2	2	0.000	C61015	C81015
11/64	.1719	3/16	5/8	2	2	0.000	C61016	C81016
3/16	.1875	3/16	5/16	2	2	0.000	C61017	C81017
3/16	.1875	3/16	5/8	2	2	0.000	C61018	C81018
3/16	.1875	3/16	5/8	2	2	0.010	C61019	C81019
3/16	.1875	3/16	3/4	2-1/2	2	0.000	C61020	C81020
3/16	.1875	3/16	1-1/8	3	2	0.000	C61021	C81021
13/64	.2031	1/4	5/8	2-1/2	2	0.000	C61022	C81022
7/32	.2188	1/4	5/8	2-1/2	2	0.000	C61023	C81023
15/64	.2344	1/4	3/4	2-1/2	2	0.000	C61024	C81024
1/4	.2500	1/4	1/2	2	2	0.000	C61025	C81025
1/4	.2500	1/4	3/4	2-1/2	2	0.000	C61026	C81026
1/4	.2500	1/4	3/4	2-1/2	2	0.020	C61027	C81027
1/4	.2500	1/4	3/4	2-1/2	2	0.030	C61028	C81028
1/4	.2500	1/4	1-1/8	3	2	0.000	C61029	C81029
1/4	.2500	1/4	1-1/2	4	2	0.000	C61030	C81030
1/4	.2500	1/4	1-1/2	6	2	0.000	C61031	C81031
17/64	.2656	5/16	7/8	2-1/2	2	0.000	C61032	C81032
9/32	.2812	5/16	7/8	2-1/2	2	0.000	C61033	C81033
5/16	.3125	5/16	1/2	2	2	0.000	C61034	C81034
5/16	.3125	5/16	7/8	2-1/2	2	0.000	C61035	C81035

continued on next page

Material Reference	Steel (HRC)		Stainless Steel			Cast Iron (HRC)		Aluminum and Non-Ferrous	Hi-Temp Alloy		Hardened Steel (HRC)	
	Low Carbon	Alloy	Austenitic	Martensitic	PH	Gray	Nodular		Ni, Co, Fe Based Super Alloy	Titanium		
	Hardness	13-38	>38	16-38	> 38	300 Series	400 series		18-22	22-32		>45
Bright	◆		◆					◆	◆	☆		
TiAlN	☆		☆		◆	◆		☆	☆			

☆ = Best Performance ◆ = Acceptable



CUSTOMER SERVICE: telephone 800.348.2885 • fax 800.892.4290

General Purpose

Style: CEM-SE2 (continued)

cutting diameter d ₁		shank diameter d ₂	length of cut l ₂ (in)	overall length l ₁ (in)	no. of flutes	corner radius	order number CEM-SE2	
fractional	decimal						bright	TiAlN
5/16	.3125	5/16	13/16	2-1/2	2	0.020	C61036	C81036
5/16	.3125	5/16	13/16	2-1/2	2	0.030	C61037	C81037
5/16	.3125	5/16	1-1/8	3	2	0.000	C61038	C81038
5/16	.3125	5/16	1-5/8	4	2	0.000	C61039	C81039
3/8	.3750	3/8	5/8	2	2	0.000	C61040	C81040
3/8	.3750	3/8	1	2-1/2	2	0.000	C61041	C81041
3/8	.3750	3/8	1	2-1/2	2	0.020	C61042	C81042
3/8	.3750	3/8	1	2-1/2	2	0.030	C61043	C81043
3/8	.3750	3/8	1	2-1/2	2	0.045	C61044	C81044
3/8	.3750	3/8	1-1/8	3	2	0.000	C61045	C81045
3/8	.3750	3/8	1 3/4	4	2	0.000	C61046	C81046
3/8	.3750	3/8	1-1/2	6	2	0.000	C61047	C81047
7/16	.4375	7/16	5/8	2-1/2	2	0.000	C61048	C81048
7/16	.4375	7/16	1	2-1/2	2	0.000	C61049	C81049
7/16	.4375	7/16	2	4	2	0.000	C61050	C81050
7/16	.4375	7/16	3	6	2	0.000	C61051	C81051
1/2	.5000	1/2	5/8	2-1/2	2	0.000	C61052	C81052
1/2	.5000	1/2	1	3	2	0.000	C61053	C81053
1/2	.5000	1/2	1	3	2	0.030	C61054	C81054
1/2	.5000	1/2	1	3	2	0.060	C61055	C81055
1/2	.5000	1/2	1	3	2	0.090	C61056	C81056
1/2	.5000	1/2	2	4	2	0.000	C61057	C81057
1/2	.5000	1/2	1-1/2	6	2	0.000	C61058	C81058
1/2	.5000	1/2	3	6	2	0.000	C61059	C81059
9/16	.5625	9/16	1-1/4	3 1/2	2	0.000	C61060	C81060
5/8	.6250	5/8	3/4	3	2	0.000	C61061	C81061
5/8	.6250	5/8	1-1/4	3 1/2	2	0.000	C61062	C81062
5/8	.6250	5/8	1-1/4	3 1/2	2	0.030	C61063	C81063
5/8	.6250	5/8	1-1/4	3 1/2	2	0.060	C61064	C81064
5/8	.6250	5/8	1-1/4	3 1/2	2	0.090	C61065	C81065
5/8	.6250	5/8	2-1/4	5	2	0.000	C61066	C81066
5/8	.6250	5/8	3	6	2	0.000	C61067	C81067
3/4	.7500	3/4	1	3	2	0.000	C61068	C81068
3/4	.7500	3/4	1-1/2	4	2	0.000	C61069	C81069
3/4	.7500	3/4	1-1/2	4	2	0.030	C61070	C81070
3/4	.7500	3/4	1-1/2	4	2	0.060	C61071	C81071
3/4	.7500	3/4	1-1/2	4	2	0.090	C61072	C81072
3/4	.7500	3/4	2-1/4	5	2	0.000	C61073	C81073
3/4	.7500	3/4	3	6	2	0.000	C61074	C81074
7/8	.8750	7/8	1-1/2	4	2	0.000	C61075	C81075
7/8	.8750	7/8	2-1/4	5	2	0.000	C61076	C81076
7/8	.8750	7/8	3	6	2	0.000	C61077	C81077
1	1.0000	1	1-1/2	4	2	0.000	C61078	C81078
1	1.0000	1	1-1/2	4	2	0.030	C61079	C81079
1	1.0000	1	1-1/2	4	2	0.060	C61080	C81080
1	1.0000	1	1-1/2	4	2	0.090	C61081	C81081
1	1.0000	1	2-1/4	5	2	0.000	C61082	C81082
1	1.0000	1	3	6	2	0.000	C61083	C81083

Carbide

Center Cutting

Material Reference	Steel (HRC)				Stainless Steel			Cast Iron (HRC)		Aluminum and Non-Ferrous	Hi-Temp Alloy		Hardened Steel (HRC)
	Low Carbon		Alloy		Austenitic	Martensitic	PH	Gray	Nodular		Ni, Co, Fe Based Super Alloy	Titanium	
	Hardness	13-38	>38	16-38	> 38	300 Series	400 series		18-22	22-32			>45
Bright	◆		◆		◆	◆		◆	◆	☆			
TiAlN	☆		☆		◆	◆		☆	☆				

☆ = Best Performance ◆ = Acceptable



Style: **CEM-SE2B**

General Purpose



Surface Treatment

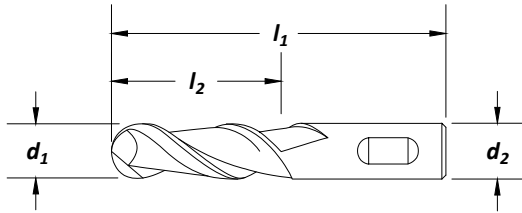

cutting diameter		shank diameter	length of cut	overall length	no. of flutes	order number	
d_1	d_1					d_2	l_2 (in)
fractional	decimal					bright	TiAlN
1/32	.0312	1/8	1/8	1-1/2	2	C60914	C80914
3/64	.0469	1/8	1/8	1-1/2	2	C60915	C80915
1/16	.0625	1/8	1/8	1-1/2	2	C60916	C80916
1/16	.0625	1/8	3/16	1-1/2	2	C60917	C80917
5/64	.0781	1/8	3/16	1-1/2	2	C60918	C80918
3/32	.0938	1/8	3/8	1-1/2	2	C60919	C80919
7/64	.1094	1/8	3/8	1-1/2	2	C60920	C80920
1/8	.1250	1/8	1/4	1-1/2	2	C60921	C80921
1/8	.1250	1/8	1/2	1-1/2	2	C60922	C80922
1/8	.1250	1/8	3/4	2-1/4	2	C60923	C80923
1/8	.1250	1/8	1	3	2	C60924	C80924
9/64	.1406	3/16	9/16	2	2	C60925	C80925
5/32	.1562	3/16	9/16	2	2	C60926	C80926
11/64	.1719	3/16	5/8	2	2	C60927	C80927
3/16	.1875	3/16	5/16	2	2	C60928	C80928
3/16	.1875	3/16	5/8	2	2	C60929	C80929
3/16	.1875	3/16	3/4	2-1/2	2	C60930	C80930
3/16	.1875	3/16	1-1/8	3	2	C60931	C80931
13/64	.2031	1/4	5/8	2-1/2	2	C60932	C80932
7/32	.2188	1/4	5/8	2-1/2	2	C60933	C80933
15/64	.2344	1/4	3/4	2-1/2	2	C60934	C80934
1/4	.2500	1/4	1/2	2	2	C60935	C80935
1/4	.2500	1/4	3/4	2-1/2	2	C60936	C80936
1/4	.2500	1/4	1-1/8	3	2	C60937	C80937
1/4	.2500	1/4	1-1/2	4	2	C60938	C80938
1/4	.2500	1/4	1-1/2	6	2	C60939	C80939
17/64	.2656	5/16	7/8	2-1/2	2	C60940	C80940
9/32	.2812	5/16	7/8	2-1/2	2	C60941	C80941
5/16	.3125	5/16	1/2	2	2	C60942	C80942
5/16	.3125	5/16	7/8	2-1/2	2	C60943	C80943
5/16	.3125	5/16	1-1/8	3	2	C60944	C80944
5/16	.3125	5/16	1-5/8	4	2	C60945	C80945
3/8	.3750	3/8	5/8	2	2	C60946	C80946
3/8	.3750	3/8	1	2-1/2	2	C60947	C80947
3/8	.3750	3/8	1-1/8	3	2	C60948	C80948
3/8	.3750	3/8	1 3/4	4	2	C60949	C80949
3/8	.3750	3/8	1-1/2	6	2	C60950	C80950

continued on next page

Material Reference	Steel (HRC)				Stainless Steel			Cast Iron (HRC)		Aluminum and Non-Ferrous	Hi-Temp Alloy		Hardened Steel (HRC)
	Low Carbon		Alloy		Austenitic	Martensitic	PH	Gray	Nodular		Ni, Co, Fe Based Super Alloy	Titanium	
	Hardness	13-38	>38	16-38	> 38	300 Series	400 series		18-22	22-32			>45
Bright	◆		◆					◆	◆	☆			
TiAlN	☆		☆		◆	◆		☆	☆				

☆ = Best Performance ◆ = Acceptable



CUSTOMER SERVICE: telephone 800.348.2885 • fax 800.892.4290

General Purpose

Style: CEM-SE2B (continued)

cutting diameter d ₁		shank diameter d ₂	length of cut l ₂ (in)	overall length l ₁ (in)	no. of flutes	order number CEM-SE2B	
fractional	decimal					bright	TiAlN
7/16	.4375	7/16	5/8	2-1/2	2	C60951	C80951
7/16	.4375	7/16	1	2-1/2	2	C60952	C80952
7/16	.4375	7/16	2	4	2	C60953	C80953
7/16	.4375	7/16	3	6	2	C60954	C80954
1/2	.5000	1/2	5/8	2-1/2	2	C60955	C80955
1/2	.5000	1/2	1	3	2	C60956	C80956
1/2	.5000	1/2	2	4	2	C60957	C80957
1/2	.5000	1/2	3	6	2	C60958	C80958
1/2	.5000	1/2	1-1/2	6	2	C60959	C80959
9/16	.5625	9/16	1-1/4	3 1/2	2	C60960	C80960
5/8	.6250	5/8	3/4	3	2	C60961	C80961
5/8	.6250	5/8	1-1/4	3 1/2	2	C60962	C80962
5/8	.6250	5/8	2-1/4	5	2	C60963	C80963
5/8	.6250	5/8	3	6	2	C60964	C80964
3/4	.7500	3/4	1	3	2	C60965	C80965
3/4	.7500	3/4	1-1/2	4	2	C60966	C80966
3/4	.7500	3/4	2-1/4	5	2	C60967	C80967
3/4	.7500	3/4	3	6	2	C60968	C80968
7/8	.8750	7/8	1-1/2	4	2	C60969	C80969
7/8	.8750	7/8	2-1/4	5	2	C60970	C80970
7/8	.8750	7/8	3	6	2	C60971	C80971
1	1.0000	1	1-1/2	4	2	C60972	C80972
1	1.0000	1	2-1/4	5	2	C60973	C80973
1	1.0000	1	3	6	2	C60974	C80974

Carbide

Center Cutting

Material Reference	Steel (HRc)				Stainless Steel			Cast Iron (HRc)		Aluminum and Non-Ferrous	Hi-Temp Alloy		Hardened Steel (HRc)
	Low Carbon		Alloy		Austenitic	Martensitic	PH	Gray	Nodular		Ni, Co, Fe Based Super Alloy	Titanium	
	Hardness	13-38	>38	16-38	> 38	300 Series	400 series		18-22	22-32			>45
Bright	◆		◆					◆	◆	☆			
TiAlN	☆		☆		◆	◆		☆	☆				

☆ = Best Performance ◆ = Acceptable



Style: CEM-SE3

General Purpose



Surface Treatment

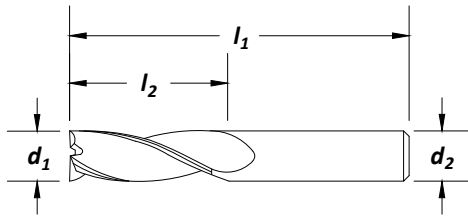

cutting diameter d_1		shank diameter d_2	length of cut l_2 (in)	overall length l_1 (in)	no. of flutes	corner radius	order number CEM-SE3	
fractional	decimal						bright	TiAlN
1/16	.0625	1/8	3/16	1-1/2	3	0.000	C61657	C81657
5/64	.0781	1/8	3/16	1-1/2	3	0.000	C61658	C81658
3/32	.0938	1/8	3/8	1-1/2	3	0.000	C61659	C81659
7/64	.1094	1/8	3/8	1-1/2	3	0.000	C61660	C81660
1/8	.1250	1/8	1/2	1-1/2	3	0.000	C61661	C81661
1/8	.1250	1/8	1/2	1-1/2	3	0.010	C61662	C81662
9/64	.1406	3/16	9/16	2	3	0.000	C61663	C81663
5/32	.1562	3/16	9/16	2	3	0.000	C61664	C81664
11/64	.1719	3/16	5/8	2	3	0.000	C61665	C81665
3/16	.1875	3/16	5/8	2	3	0.000	C61666	C81666
3/16	.1875	3/16	5/8	2	3	0.010	C61667	C81667
13/64	.2031	1/4	5/8	2-1/2	3	0.000	C61668	C81668
7/32	.2188	1/4	5/8	2-1/2	3	0.000	C61669	C81669
15/64	.2344	1/4	3/4	2-1/2	3	0.000	C61670	C81670
1/4	.2500	1/4	3/4	2-1/2	3	0.000	C61671	C81671
1/4	.2500	1/4	3/4	2-1/2	3	0.020	C61672	C81672
1/4	.2500	1/4	3/4	2-1/2	3	0.030	C61673	C81673
17/64	.2656	5/16	7/8	2-1/2	3	0.000	C61674	C81674
9/32	.2812	5/16	7/8	2-1/2	3	0.000	C61675	C81675
5/16	.3125	5/16	13/16	2-1/2	3	0.000	C61676	C81676
5/16	.3125	5/16	13/16	2-1/2	3	0.020	C61677	C81677
5/16	.3125	5/16	13/16	2-1/2	3	0.030	C61678	C81678
3/8	.3750	3/8	7/8	2-1/2	3	0.000	C61679	C81679
3/8	.3750	3/8	7/8	2-1/2	3	0.020	C61680	C81680
3/8	.3750	3/8	7/8	2-1/2	3	0.030	C61681	C81681
3/8	.3750	3/8	7/8	2-1/2	3	0.045	C61682	C81682
7/16	.4375	7/16	7/8	2-1/2	3	0.000	C61683	C81683
1/2	.5000	1/2	1	3	3	0.000	C61684	C81684
1/2	.5000	1/2	1	3	3	0.030	C61685	C81685
1/2	.5000	1/2	1	3	3	0.060	C61686	C81686
1/2	.5000	1/2	1	3	3	0.090	C61687	C81687
9/16	.5625	9/16	1-1/4	3 1/2	3	0.000	C61688	C81688
5/8	.6250	5/8	1-1/4	3 1/2	3	0.000	C61689	C81689
5/8	.6250	5/8	1-1/4	3 1/2	3	0.030	C61690	C81690
5/8	.6250	5/8	1-1/4	3 1/2	3	0.060	C61691	C81691
5/8	.6250	5/8	1-1/4	3 1/2	3	0.090	C61692	C81692
3/4	.7500	3/4	1-1/2	4	3	0.000	C61693	C81693
3/4	.7500	3/4	1-1/2	4	3	0.030	C61694	C81694
3/4	.7500	3/4	1-1/2	4	3	0.060	C61695	C81695
3/4	.7500	3/4	1-1/2	4	3	0.090	C61696	C81696
7/8	.8750	7/8	1-1/2	4	3	0.000	C61697	C81697
1	1.0000	1	1-1/2	4	3	0.000	C61698	C81698
1	1.0000	1	1-1/2	4	3	0.030	C61699	C81699
1	1.0000	1	1-1/2	4	3	0.060	C61700	C81700
1	1.0000	1	1-1/2	4	3	0.090	C61701	C81701

Carbide

Center Cutting

Material Reference	Steel (HRc)		Stainless Steel			Cast Iron (HRc)		Aluminum and Non-Ferrous	Hi-Temp Alloy		Hardened Steel (HRc)	
	Low Carbon		Alloy	Austenitic	Martensitic	PH	Gray		Nodular	Ni, Co, Fe Based Super Alloy		Titanium
	Hardness	13-38	>38	16-38	> 38	300 Series	400 series					>45
Bright	◆		◆					◆	◆	☆		
TiAlN	☆		☆		◆	◆		☆	☆			

☆ = Best Performance ◆ = Acceptable



CUSTOMER SERVICE: telephone 800.348.2885 • fax 800.892.4290

Note
 General purpose applications.
 30° right hand spiral-right hand cut
 Diameter tolerance: ±0.0005"



Surface
Treatment

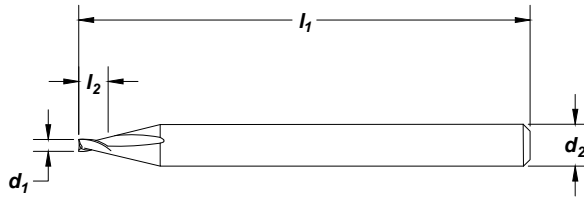

cutting diameter d₁	shank diameter d₂	length of cut l₂ (in)	overall length l₁ (in)	description	order number	
					CMCE-4 Bright	CMCE-4AL AlCrN
0.0100	1/8	0.0300	1-1/2	0.0100x1/8x1-1/2	C76057	—
0.0110	1/8	0.0330	1-1/2	0.0110x1/8x1-1/2	C76058	—
0.0120	1/8	0.0360	1-1/2	0.0120x1/8x1-1/2	C76059	—
0.0130	1/8	0.0390	1-1/2	0.0130x1/8x1-1/2	C76060	—
0.0140	1/8	0.0420	1-1/2	0.0140x1/8x1-1/2	C76061	—
0.0150	1/8	0.0450	1-1/2	0.0150x1/8x1-1/2	C76062	—
0.0200	1/8	0.0600	1-1/2	0.0200x1/8x1-1/2	C76063	—
0.0250	1/8	0.0750	1-1/2	0.0250x1/8x1-1/2	C76064	—
0.0260	1/8	0.0780	1-1/2	0.0260x1/8x1-1/2	C76065	—
0.0300	1/8	0.0900	1-1/2	0.0300x1/8x1-1/2	C76066	—
0.0312	1/8	0.0930	1-1/2	0.0312x1/8x1-1/2	C76067	C76235
0.0330	1/8	0.0990	1-1/2	0.0330x1/8x1-1/2	C76068	C76236
0.0350	1/8	0.1050	1-1/2	0.0350x1/8x1-1/2	C76069	C76237
0.0400	1/8	0.1200	1-1/2	0.0400x1/8x1-1/2	C76070	C76238
0.0450	1/8	0.1350	1-1/2	0.0450x1/8x1-1/2	C76071	C76239
0.0470	1/8	0.1410	1-1/2	0.0470x1/8x1-1/2	C76072	C76240
0.0500	1/8	0.1500	1-1/2	0.0500x1/8x1-1/2	C76073	C76241
0.0550	1/8	0.1650	1-1/2	0.0550x1/8x1-1/2	C76074	C76242
0.0600	1/8	0.180	1-1/2	0.0600x1/8x1-1/2	C76075	C76243
0.0625	1/8	0.1875	1-1/2	0.0625x1/8x1-1/2	C76076	C76244
0.0640	1/8	0.1920	1-1/2	0.0640x1/8x1-1/2	C76077	C76245
0.0650	1/8	0.1950	1-1/2	0.0650x1/8x1-1/2	C76078	C76246
0.0700	1/8	0.2100	1-1/2	0.0700x1/8x1-1/2	C76079	C76247
0.0750	1/8	0.2250	1-1/2	0.0750x1/8x1-1/2	C76080	C76248
0.0780	1/8	0.2343	1-1/2	0.0780x1/8x1-1/2	C76081	C76249
0.0800	1/8	0.2400	1-1/2	0.0800x1/8x1-1/2	C76082	C76250
0.0850	1/8	0.2550	1-1/2	0.0850x1/8x1-1/2	C76083	C76251
0.0900	1/8	0.2700	1-1/2	0.0900x1/8x1-1/2	C76084	C76252
0.0938	1/8	0.2814	1-1/2	0.0938x1/8x1-1/2	C76085	C76253
0.0950	1/8	0.2850	1-1/2	0.0950x1/8x1-1/2	C76086	C76254
0.1000	1/8	0.3000	1-1/2	0.1000x1/8x1-1/2	C76087	C76255
0.1030	1/8	0.3090	1-1/2	0.1030x1/8x1-1/2	C76088	C76256
0.1200	1/8	0.3600	1-1/2	0.1200x1/8x1-1/2	C76089	C76257

continued on next page

cutting diameter		shank diameter	length of cut	overall length	description	order number	
d ₁	d ₂					CMCE-4	CMCE-4AL
(mm)	(in)		l ₂ (in)	l ₁ (in)		Bright	AlCrN
.5mm	0.0197	1/8	0.0591	1-1/2	.5mmx1/8x1-1/2	C76090	—
1.0mm	0.0394	1/8	0.1182	1-1/2	1.0mmx1/8x1-1/2	C76091	C76258
1.25mm	0.0492	1/8	0.1476	1-1/2	1.25mmx1/8x1-1/2	C76092	C76259
1.5mm	0.0591	1/8	0.1773	1-1/2	1.5mmx1/8x1-1/2	C76093	C76260
1.6mm	0.0630	1/8	0.1890	1-1/2	1.6mmx1/8x1-1/2	C76094	C76261
1.8mm	0.0709	1/8	0.2127	1-1/2	1.8mmx1/8x1-1/2	C76095	C76262
2.0mm	0.0787	1/8	0.2361	1-1/2	2.0mmx1/8x1-1/2	C76096	C76263
2.2mm	0.0866	1/8	0.2598	1-1/2	2.2mmx1/8x1-1/2	C76097	C76264
2.5mm	0.0984	1/8	0.2952	1-1/2	2.5mmx1/8x1-1/2	C76098	C76265
2.8mm	0.1102	1/8	0.3306	1-1/2	2.8mmx1/8x1-1/2	C76099	C76266
3.0mm	0.1181	1/8	0.3543	1-1/2	3.0mmx1/8x1-1/2	C76100	C76267
3.5mm	0.1378	3/16	0.1875	2	3.5mmx3/16x2	C76101	C76268
4.5mm	0.1772	3/16	0.5316	2	4.5mmx3/16x2	C76102	C76269

Material Reference	Steel (HRc)				Stainless Steel			Cast Iron (HRc)		Aluminum and Non-Ferrous	Hi-Temp Alloy		Hardened Steel (HRc)
	Low Carbon		Alloy		Austenitic	Martensitic	PH	Gray	Nodular		Ni, Co, Fe Based Super Alloy	Titanium	
	Hardness	13-38	>38	16-38	> 38	300 Series	400 series		18-22	22-32			>45
Bright	◆		◆		◆	◆		◆	◆				
AlCrN	☆	◆	☆	◆	☆	☆	◆	☆	☆	☆	◆	◆	◆

☆ = Best Performance ◆ = Acceptable

General Purpose

Style: **CEM-SE4**

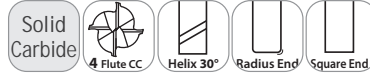

Surface Treatment

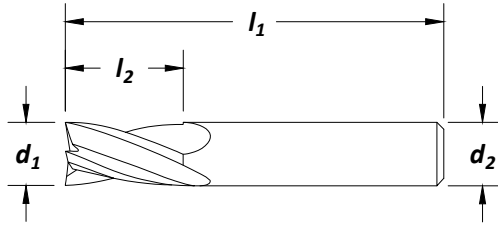

cutting diameter		mm	shank diameter	length of cut	overall length	no. of flutes	corner radius	order number	
fractional	decimal		d ₂	l ₂ (in)	l ₁ (in)			CEM-SE4 bright	TiAlN
1/32	.0312		1/8	1/16	1-1/2	4	0.000	C61805	C81805
1/32	.0312		1/8	1/8	1-1/2	4	0.000	C61806	C81806
	.0394	1.00	3	3.0	38	4	0.000	C98215	C98240
3/64	.0469		1/8	1/8	1-1/2	4	0.000	C61807	C81807
	.0591	1.50	3	5.0	38	4	0.000	C98216	C98241
1/16	.0625		1/8	1/8	1-1/2	4	0.000	C61808	C81808
1/16	.0625		1/8	3/16	1-1/2	4	0.000	C61809	C81809
1/16	.0625		1/8	1/4	1-1/2	4	0.010	C61810	C81810
5/64	.0781		1/8	3/16	1-1/2	4	0.000	C61811	C81811
	.0788	2.00	3	6.0	38	4	0.000	C98217	C98242
3/32	.0938		1/8	3/16	1-1/2	4	0.000	C61812	C81812
3/32	.0938		1/8	3/8	1-1/2	4	0.000	C61813	C81813
3/32	.0938		1/8	3/8	1-1/2	4	0.010	C61814	C81814
3/32	.0938		1/8	3/8	1-1/2	4	0.020	C61815	C81815
	.0985	2.50	3	7.0	38	4	0.000	C98218	C98243
7/64	.1094		1/8	1/4	1-1/2	4	0.000	C61816	C81816
7/64	.1094		1/8	3/8	1-1/2	4	0.000	C61817	C81817
	.1182	3.00	3	12.0	38	4	0.000	C98219	C98244
1/8	.1250		1/8	1/4	1-1/2	4	0.000	C61818	C81818
1/8	.1250		1/8	1/2	1-1/2	4	0.000	C61819	C81819
1/8	.1250		1/8	1/2	1-1/2	4	0.010	C61820	C81820
1/8	.1250		1/8	1/2	1-1/2	4	0.015	C61821	C81821
1/8	.1250		1/8	1/2	1-1/2	4	0.020	C61822	C81822
1/8	.1250		1/8	3/4	2-1/4	4	0.000	C61824	C81824
1/8	.1250		1/8	1	3	4	0.000	C61825	C81825
	.1378	3.50	4	12.0	50	4	0.000	C98220	C98245
9/64	.1406		3/16	9/16	2	4	0.000	C61827	C81827
5/32	.1562		3/16	5/16	2	4	0.000	C61828	C81828
5/32	.1562		3/16	9/16	2	4	0.000	C61829	C81829
	.1575	4.00	4	14.0	50	4	0.000	C98221	C98246
11/64	.1719		3/16	5/8	2	4	0.000	C61830	C81830
	.1772	4.50	5	14.0	50	4	0.000	C98222	C98247
3/16	.1875		3/16	5/16	2	4	0.000	C61831	C81831
3/16	.1875		3/16	5/8	2	4	0.000	C61832	C81832
3/16	.1875		3/16	5/8	2	4	0.010	C61833	C81833
3/16	.1875		3/16	5/8	2	4	0.015	C61834	C81834
3/16	.1875		3/16	5/8	2	4	0.020	C61835	C81835
3/16	.1875		3/16	5/8	2	4	0.030	C61836	C81836
3/16	.1875		3/16	3/4	2-1/2	4	0.000	C61837	C81837
3/16	.1875		3/16	1	3	4	0.000	C61838	C81838
3/16	.1875		3/16	1	3	4	0.045	C61839	C81839
3/16	.1875		3/16	1-1/8	3	4	0.000	C61840	C81840
3/16	.1875		3/16	1	4	4	0.000	C61841	C81841
3/16	.1875		3/16	1	4	4	0.045	C61842	C81842
	.1969	5.00	5	16.0	50	4	0.000	C98223	C98248
13/64	.2031		1/4	5/8	2-1/2	4	0.000	C61843	C81843
	.2166	5.50	6	16.0	50	4	0.000	C98224	C98249

Carbide

Center Cutting

continued on next page



Style: **CEM-SE4** (continued)

General Purpose

cutting diameter		shank diameter	length of cut	overall length	no. of flutes	corner radius	order number		
d₁	d₂						CEM-SE4		
fractional	decimal	mm	d₂	l₂ (in)	l₁ (in)		bright	TiAIN	
7/32	.2188		1/4	5/8	2-1/2	4	0.000	C61844	C81844
15/64	.2344		1/4	3/4	2-1/2	4	0.000	C61845	C81845
	.2363	6.00	6	19.0	50	4	0.000	C98225	C98250
1/4	.2500		1/4	1/2	2	4	0.000	C61846	C81846
1/4	.2500		1/4	3/4	2-1/2	4	0.000	C61847	C81847
1/4	.2500		1/4	3/4	2-1/2	4	0.010	C61848	C81848
1/4	.2500		1/4	3/4	2-1/2	4	0.015	C61849	C81849
1/4	.2500		1/4	3/4	2-1/2	4	0.020	C61850	C81850
1/4	.2500		1/4	3/4	2-1/2	4	0.030	C61851	C81851
1/4	.2500		1/4	3/4	2-1/2	4	0.045	C61852	C81852
1/4	.2500		1/4	3/4	2-1/2	4	0.060	C61853	C81853
1/4	.2500		1/4	1-1/8	3	4	0.000	C61854	C81854
1/4	.2500		1/4	1-1/2	4	4	0.000	C61855	C81855
1/4	.2500		1/4	1-1/2	6	4	0.000	C61856	C81856
	.2560	6.50	8	19.0	63	4	0.000	C98226	C98251
17/64	.2656		5/16	7/8	2-1/2	4	0.000	C61857	C81857
	.2756	7.00	8	19.0	63	4	0.000	C98227	C98252
9/32	.2812		5/16	7/8	2-1/2	4	0.000	C61858	C81858
	.2953	7.50	8	19.0	63	4	0.000	C98228	C98253
19/64	.2969		5/16	7/8	2-1/2	4	0.000	C61859	C81859
5/16	.3125		5/16	1/2	2	4	0.000	C61860	C81860
5/16	.3125		5/16	7/8	2-1/2	4	0.000	C61861	C81861
5/16	.3125		5/16	13/16	2-1/2	4	0.020	C61862	C81862
5/16	.3125		5/16	13/16	2-1/2	4	0.030	C61863	C81863
5/16	.3125		5/16	1	4	4	0.000	C61864	C81864
5/16	.3125		5/16	1-1/8	3	4	0.000	C61865	C81865
5/16	.3125		5/16	1-5/8	4	4	0.000	C61866	C81866
	.3150	8.00	8	19.0	63	4	0.000	C98229	C98254
21/64	.3281		3/8	7/8	2-1/2	4	0.000	C61867	C81867
11/32	.3438		3/8	7/8	2-1/2	4	0.000	C61868	C81868
	.3544	9.00	10	22.0	70	4	0.000	C98230	C98255
23/64	.3594		3/8	7/8	2-1/2	4	0.000	C61869	C81869
3/8	.3750		3/8	5/8	2	4	0.000	C61870	C81870
3/8	.3750		3/8	1	2-1/2	4	0.000	C61871	C81871
3/8	.3750		3/8	1	2-1/2	4	0.010	C61872	C81872
3/8	.3750		3/8	1	2-1/2	4	0.015	C61873	C81873
3/8	.3750		3/8	1	2-1/2	4	0.020	C61874	C81874
3/8	.3750		3/8	1	2-1/2	4	0.030	C61875	C81875
3/8	.3750		3/8	1	2-1/2	4	0.045	C61876	C81876
3/8	.3750		3/8	1	2-1/2	4	0.060	C61877	C81877
3/8	.3750		3/8	1	4	4	0.000	C61879	C81879
3/8	.3750		3/8	1	4	4	0.020	C61880	C81880
3/8	.3750		3/8	1-1/8	3	4	0.000	C61878	C81878
3/8	.3750		3/8	1 3/4	4	4	0.000	C61881	C81881
3/8	.3750		3/8	1-1/2	6	4	0.000	C61882	C81882
25/64	.3906		7/16	7/8	2-1/2	4	0.000	C61883	C81883
	.3938	10.00	10	22.0	70	4	0.000	C98231	C98256
13/32	.4062		7/16	7/8	2-1/2	4	0.000	C61884	C81884
27/64	.4218		7/16	7/8	2-1/2	4	0.000	C61885	C81885

continued on next page

Material Reference	Steel (HRc)		Stainless Steel			Cast Iron (HRc)		Aluminum and Non-Ferrous	Hi-Temp Alloy		Hardened Steel (HRc)	
	Low Carbon		Alloy	Austenitic	Martensitic	PH	Gray		Nodular	Ni, Co, Fe Based Super Alloy		Titanium
	Hardness	13-38	>38	16-38	> 38	300 Series	400 series					>45
Bright	◆		◆					◆	◆	☆		
TiAIN	☆		☆		◆	◆		☆	☆			

☆ = Best Performance ◆ = Acceptable



General Purpose

Style: CEM-SE4 (continued)

cutting diameter		shank diameter d ₂	length of cut l ₂ (in)	overall length l ₁ (in)	no. of flutes	corner radius	order number		
d ₁	d ₁						CEM-SE4		
fractional	decimal	mm					bright	TiAlN	
	.4331	11.00	11	25.0	70	4	0.000	C98232	C98257
7/16	.4375		7/16	5/8	2-1/2	4	0.000	C61886	C81886
7/16	.4375		7/16	1	2-1/2	4	0.000	C61887	C81887
7/16	.4375		7/16	2	4	4	0.000	C61888	C81888
7/16	.4375		7/16	3	6	4	0.000	C61889	C81889
29/64	.4531		1/2	1	3	4	0.000	C61890	C81890
15/32	.4688		1/2	1	3	4	0.000	C61891	C81891
	.4725	12.00	12	25.0	75	4	0.000	C98233	C98258
31/64	.4844		1/2	1	3	4	0.000	C61892	C81892
1/2	.5000		1/2	5/8	2-1/2	4	0.000	C61893	C81893
1/2	.5000		1/2	1	3	4	0.000	C61894	C81894
1/2	.5000		1/2	1	3	4	0.015	C61895	C81895
1/2	.5000		1/2	1	3	4	0.020	C61896	C81896
1/2	.5000		1/2	1	3	4	0.030	C61897	C81897
1/2	.5000		1/2	1	3	4	0.045	C61898	C81898
1/2	.5000		1/2	1	3	4	0.060	C61899	C81899
1/2	.5000		1/2	1	3	4	0.090	C61900	C81900
1/2	.5000		1/2	1	3	4	0.125	C61901	C81901
1/2	.5000		1/2	2	4	4	0.000	C61902	C81902
1/2	.5000		1/2	3	6	4	0.000	C61903	C81903
1/2	.5000		1/2	1-1/2	6	4	0.000	C61904	C81904
	.5512	14.00	14	30.0	88	4	0.000	C98234	C98259
9/16	.5625		9/16	1-1/4	3 1/2	4	0.000	C61905	C81905
5/8	.6250		5/8	3/4	3	4	0.000	C61906	C81906
5/8	.6250		5/8	1-1/4	3 1/2	4	0.000	C61907	C81907
5/8	.6250		5/8	1-1/4	3 1/2	4	0.030	C61908	C81908
5/8	.6250		5/8	1-1/4	3 1/2	4	0.060	C61909	C81909
5/8	.6250		5/8	1-1/4	3 1/2	4	0.090	C61910	C81910
5/8	.6250		5/8	2-1/4	5	4	0.000	C61911	C81911
5/8	.6250		5/8	3	6	4	0.000	C61912	C81912
	.6300	16.00	16	32.0	88	4	0.000	C98235	C98260
	.7087	18.00	18	36.0	100	4	0.000	C98236	C98261
3/4	.7500		3/4	1	3	4	0.000	C61913	C81913
3/4	.7500		3/4	1-1/2	4	4	0.000	C61914	C81914
3/4	.7500		3/4	1-1/2	4	4	0.030	C61915	C81915
3/4	.7500		3/4	1-1/2	4	4	0.060	C61916	C81916
3/4	.7500		3/4	1-1/2	4	4	0.090	C61917	C81917
3/4	.7500		3/4	2-1/4	5	4	0.000	C61918	C81918
3/4	.7500		3/4	3	6	4	0.000	C61919	C81919
	.7875	20.00	20	38.0	100	4	0.000	C98237	C98262
7/8	.8750		7/8	1-1/2	4	4	0.000	C61920	C81920
7/8	.8750		7/8	2-1/4	5	4	0.000	C61921	C81921
7/8	.8750		7/8	3	6	4	0.000	C61922	C81922
	.9843	25.00	25	38.0	100	4	0.000	C98238	C98263
1	1.0000		1	1-1/2	4	4	0.000	C61923	C81923
1	1.0000		1	1-1/2	4	4	0.030	C61924	C81924
1	1.0000		1	1-1/2	4	4	0.060	C61925	C81925
1	1.0000		1	1-1/2	4	4	0.090	C61926	C81926
1	1.0000		1	2-1/4	5	4	0.000	C61927	C81927
1	1.0000		1	3	6	4	0.000	C61928	C81928

Carbide
Center Cutting

Material Reference	Steel (HRC)				Stainless Steel			Cast Iron (HRC)		Aluminum and Non-Ferrous	Hi-Temp Alloy		Hardened Steel (HRC)
	Low Carbon		Alloy		Austenitic	Martensitic	PH	Gray	Nodular		Ni, Co, Fe Based Super Alloy	Titanium	
	Hardness	13-38	>38	16-38	> 38	300 Series	400 series		18-22	22-32			>45
Bright	◆		◆					◆	◆	☆			
TiAlN	☆		☆		◆	◆		☆	☆				

☆ = Best Performance ◆ = Acceptable



Style: **CEM-SE4B**

General Purpose



Surface Treatment

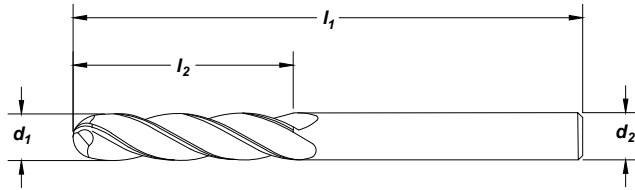

cutting diameter d₁		shank diameter d₂	length of cut l₂ (in)	overall length l₁ (in)	no. of flutes	order number CEM-SE4B	
fractional	decimal					bright	TiAlN
1/32	.0312	1/8	1/16	1-1/2	4	C63509	C83509
1/32	.0312	1/8	1/8	1-1/2	4	C63510	C83510
1/32	.0312	1/8	3/32	1-1/2	4	C63511	C83511
3/64	.0469	1/8	1/8	1-1/2	4	C63512	C83512
1/16	.0625	1/8	1/8	1-1/2	4	C63513	C83513
1/16	.0625	1/8	3/16	1-1/2	4	C63514	C83514
5/64	.0781	1/8	3/16	1-1/2	4	C63515	C83515
3/32	.0938	1/8	3/8	1-1/2	4	C63516	C83516
3/32	.0938	1/8	3/16	1-1/2	4	C63517	C83517
7/64	.1094	1/8	3/8	1-1/2	4	C63518	C83518
1/8	.1250	1/8	1/4	1-1/2	4	C63519	C83519
1/8	.1250	1/8	1/2	1-1/2	4	C63520	C83520
1/8	.1250	1/8	5/8	2	4	C63521	C83521
1/8	.1250	1/8	3/4	2-1/4	4	C63522	C83522
1/8	.1250	1/8	1	3	4	C63523	C83523
9/64	.1406	3/16	9/16	2	4	C63524	C83524
5/32	.1562	3/16	5/16	2	4	C63525	C83525
5/32	.1562	3/16	9/16	2	4	C63526	C83526
11/64	.1719	3/16	5/8	2	4	C63527	C83527
3/16	.1875	3/16	5/16	2	4	C63528	C83528
3/16	.1875	3/16	5/8	2	4	C63529	C83529
3/16	.1875	3/16	3/4	2-1/2	4	C63530	C83530
3/16	.1875	3/16	1-1/8	3	4	C63531	C83531
13/64	.2031	1/4	5/8	2-1/2	4	C63532	C83532
7/32	.2188	1/4	5/8	2-1/2	4	C63533	C83533
15/64	.2344	1/4	3/4	2-1/2	4	C63534	C83534
1/4	.2500	1/4	1/2	2	4	C63535	C83535
1/4	.2500	1/4	3/4	2-1/2	4	C63536	C83536
1/4	.2500	1/4	1	4	4	C63537	C83537
1/4	.2500	1/4	1-1/8	3	4	C63538	C83538
1/4	.2500	1/4	1-1/2	4	4	C63539	C83539
1/4	.2500	1/4	1-1/2	6	4	C63540	C83540

continued on next page

Material Reference	Steel (HRC)				Stainless Steel			Cast Iron (HRC)		Aluminum and Non-Ferrous	Hi-Temp Alloy		Hardened Steel (HRC)
	Low Carbon		Alloy		Austenitic	Martensitic	PH	Gray	Nodular		Ni, Co, Fe Based Super Alloy	Titanium	
	Hardness	13-38	>38	16-38	> 38	300 Series	400 series		18-22	22-32			>45
Bright	◆		◆					◆	◆	☆			
TiAlN	☆		☆		◆	◆		☆	☆				

☆ = Best Performance ◆ = Acceptable



CUSTOMER SERVICE: telephone 800.348.2885 • fax 800.892.4290

General Purpose

Style: CEM-SE4B (continued)

cutting diameter d ₁		shank diameter d ₂	length of cut l ₂ (in)	overall length l ₁ (in)	no. of flutes	order number CEM-SE4B	
fractional	decimal					bright	TiAIN
17/64	.2656	5/16	7/8	2-1/2	4	C63541	C83541
9/32	.2812	5/16	7/8	2-1/2	4	C63542	C83542
5/16	.3125	5/16	1/2	2	4	C63543	C83543
5/16	.3125	5/16	7/8	2-1/2	4	C63544	C83544
5/16	.3125	5/16	1-1/8	3	4	C63545	C83545
5/16	.3125	5/16	1-5/8	4	4	C63546	C83546
23/64	.3594	3/8	7/8	2-1/2	4	C63547	C83547
3/8	.3750	3/8	5/8	2	4	C63548	C83548
3/8	.3750	3/8	1	2-1/2	4	C63549	C83549
3/8	.3750	3/8	1-1/8	3	4	C63550	C83550
3/8	.3750	3/8	1-1/2	6	4	C63551	C83551
3/8	.3750	3/8	1 3/4	4	4	C63552	C83552
25/64	.3906	7/16	7/8	2-1/2	4	C63553	C83553
27/64	.4219	7/16	7/8	2-1/2	4	C63554	C83554
7/16	.4375	7/16	5/8	2-1/2	4	C63555	C83555
7/16	.4375	7/16	1	2-1/2	4	C63556	C83556
7/16	.4375	7/16	2	4	4	C63557	C83557
7/16	.4375	7/16	3	6	4	C63558	C83558
31/64	.4844	1/2	1	3	4	C63559	C83559
1/2	.5000	1/2	5/8	2-1/2	4	C63560	C83560
1/2	.5000	1/2	1	3	4	C63561	C83561
1/2	.5000	1/2	2	4	4	C63562	C83562
1/2	.5000	1/2	1-1/2	6	4	C63563	C83563
1/2	.5000	1/2	3	6	4	C63564	C83564
9/16	.5625	9/16	1-1/4	3 1/2	4	C63565	C83565
5/8	.6250	5/8	3/4	3	4	C63566	C83566
5/8	.6250	5/8	1-1/4	3 1/2	4	C63567	C83567
5/8	.6250	5/8	2-1/4	5	4	C63568	C83568
5/8	.6250	5/8	3	6	4	C63569	C83569
3/4	.7500	3/4	1	3	4	C63570	C83570
3/4	.7500	3/4	1-1/2	4	4	C63571	C83571
3/4	.7500	3/4	2-1/4	5	4	C63572	C83572
3/4	.7500	3/4	3	6	4	C63573	C83573
7/8	.8750	7/8	1-1/2	4	4	C63574	C83574
7/8	.8750	7/8	2-1/4	5	4	C63575	C83575
7/8	.8750	7/8	3	6	4	C63576	C83576
1	1.0000	1	1-1/2	4	4	C63577	C83577
1	1.0000	1	2-1/4	5	4	C63578	C83578
1	1.0000	1	3	6	4	C63579	C83579

Carbide

Center Cutting

Material Reference	Steel (HRc)				Stainless Steel			Cast Iron (HRc)		Aluminum and Non-Ferrous	Hi-Temp Alloy		Hardened Steel (HRc)
	Low Carbon		Alloy		Austenitic	Martensitic	PH	Gray	Nodular		Ni, Co, Fe Based Super Alloy	Titanium	
	Hardness	13-38	>38	16-38	> 38	300 Series	400 series		18-22	22-32			>45
Bright	◆		◆					◆	◆	☆			
TiAIN	☆		☆		◆	◆		☆	☆				

☆ = Best Performance ◆ = Acceptable

Style: CEM-SEST2

Solid Carbide
 2 Flute CC
 Straight Flute
 Surface Treatment
 Bright
 TiAlN

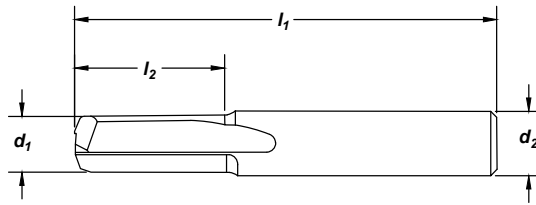

cutting diameter d₁		shank diameter d₂	length of cut l₂ (i n)	overall length l₁ (in)	no. of flutes	order number CEM-SEST2	
fractional	decimal					bright	TiAlN
1/16	.0625	1/8	3/16	1-1/2	2	C60649	C80649
1/8	.1250	1/8	1/2	1-1/2	2	C60650	C80650
3/16	.1875	3/16	5/8	2	2	C60651	C80651
1/4	.2500	1/4	3/4	2-1/2	2	C60652	C80652
5/16	.3125	5/16	13/16	2-1/2	2	C60653	C80653
3/8	.3750	3/8	7/8	2-1/2	2	C60654	C80654
1/2	.5000	1/2	1	3	2	C60655	C80655

Material Reference	Steel (HRc)		Stainless Steel			Cast Iron (HRc)		Aluminum and Non-Ferrous	Hi-Temp Alloy		Hardened Steel (HRc)	
	Low Carbon		Austenitic	Martensitic	PH	Gray	Nodular		Ni, Co, Fe Based Super Alloy	Titanium		
	Hardness	13-38	>38	16-38	> 38	300 Series	400 series		18-22	22-32		>45
Bright	◆		◆					◆	◆	☆		
TiAlN	☆		☆		◆	◆		☆	☆			◆

☆ = Best Performance ◆ = Acceptable

Style: CEM-EG2

Engraving Tool

Solid Carbide
 2 Flute CC
 Ball End
 Surface Treatment
 TiCN

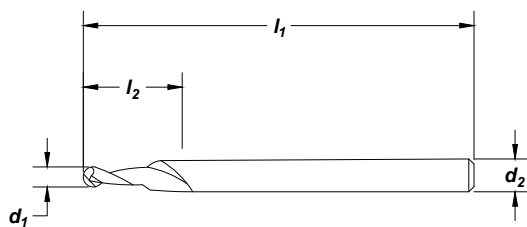

cutting diameter d₁		shank diameter d₂	length of cut l₂ (in)	overall length l₁ (in)	no. of flutes	order number CEM-EG2	
decimal	metric					TiCN	
.021	0.53	1/8	.040	1-1/2	2	C70374	
.025	0.64	1/8	.040	1-1/2	2	C70375	
.030	0.76	1/8	.040	1-1/2	2	C70376	

Material Reference	Steel (HRc)		Stainless Steel			Cast Iron (HRc)		Aluminum and Non-Ferrous	Hi-Temp Alloy		Hardened Steel (HRc)	
	Low Carbon		Austenitic	Martensitic	PH	Gray	Nodular		Ni, Co, Fe Based Super Alloy	Titanium		
	Hardness	13-38	>38	16-38	> 38	300 Series	400 series		18-22	22-32		>45
TiCN	☆		☆					☆	☆	☆		

☆ = Best Performance ◆ = Acceptable

Note
60°, 82°, 90°, & 120° Point

Solid Carbide

2 Flute CC

Surface Treatment

Bright

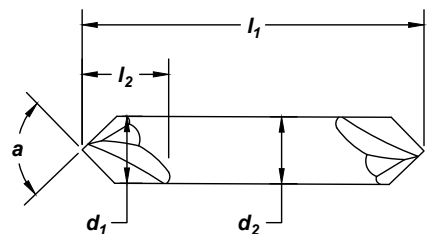
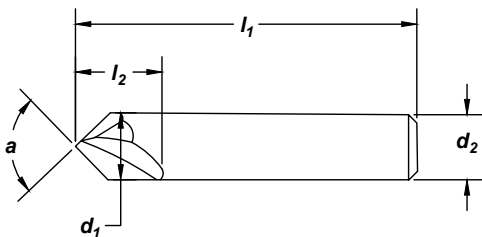

cutting diameter d₁		shank diameter d₂	length of cut l₂ (in)	overall length l₁ (in)	profile angle (°) a	order number	
fractional	decimal					CEM-CH2 single end	CEM-CH2D double end
1/8	.1250	1/8	1-1/2	2	60	C61112	-
1/8	.1250	1/8	1-1/2	2	82	C61113	-
1/8	.1250	1/8	1-1/2	2	90	C61114	C61226
3/16	.1875	3/16	2	2	90	C61115	C61227
1/4	.2500	1/4	2-1/2	2	60	C61116	-
1/4	.2500	1/4	2-1/2	2	82	C61117	-
1/4	.2500	1/4	2-1/2	2	90	C61118	C61228
3/8	.3750	3/8	2-1/2	2	60	C61119	-
3/8	.3750	3/8	2-1/2	2	82	C61120	-
3/8	.3750	3/8	2-1/2	2	90	C61121	C61229
3/8	.3750	3/8	2-1/2	2	120	C61127	-
1/2	.5000	1/2	3	2	60	C61122	-
1/2	.5000	1/2	3	2	82	C61123	-
1/2	.5000	1/2	3	2	90	C61124	C61230
1/2	.5000	1/2	3	2	120	C61125	-
3/4	.7500	3/4	4	2	90	C61126	C61231

Carbide
Center Cutting

Material Reference	Steel (HRC)				Stainless Steel			Cast Iron (HRC)		Aluminum and Non-Ferrous	Hi-Temp Alloy		Hardened Steel (HRC)
	Low Carbon		Alloy		Austenitic	Martensitic	PH	Gray	Nodular		Ni, Co, Fe Based Super Alloy	Titanium	
Hardness	13-38	>38	16-38	> 38	300 Series	400 series		18-22	22-32				>45
Bright	☆	◆	☆	◆						◆			

☆ = Best Performance ◆ = Acceptable

Styles: CEM-CH4 Single End CEM-CH4D Double End
Note
 60°, 82°, 90°, & 120° Point

Solid Carbide



Surface Treatment

Bright

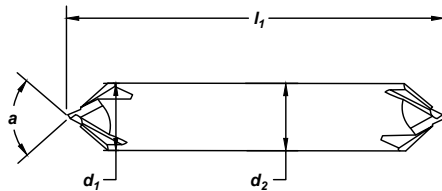
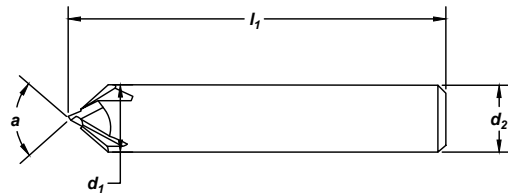

cutting diameter d₁		shank diameter d₂	length of cut l₂ (in)	overall length l₁ (in)	profile angle (°) a	order number	
fractional	decimal					CEM-CH4 single end	CEM-CH4D double end
1/4	.2500	1/4	2-1/2	4	60	C66219	-
1/4	.2500	1/4	2-1/2	4	82	C66220	-
1/4	.2500	1/4	2-1/2	4	90	C66221	C60228
3/8	.3750	3/8	2-1/2	4	60	C66222	-
3/8	.3750	3/8	2-1/2	4	82	C66223	-
3/8	.3750	3/8	2-1/2	4	90	C66224	C60229
3/8	.3750	3/8	2-1/2	4	120	C66218	-
1/2	.5000	1/2	3	4	60	C66225	-
1/2	.5000	1/2	3	4	82	C66226	-
1/2	.5000	1/2	3	4	90	C66227	C60230
1/2	.5000	1/2	3	4	120	C66228	-
3/4	.7500	3/4	4	4	90	C66229	C60231

Carbide
Center Cutting

Material Reference	Steel (HRC)		Stainless Steel			Cast Iron (HRC)		Aluminum and Non-Ferrous	Hi-Temp Alloy		Hardened Steel (HRC)
	Low Carbon	Alloy	Austenitic	Martensitic	PH	Gray	Nodular		Ni, Co, Fe Based Super Alloy	Titanium	
Hardness	13-38	>38	16-38	> 38	300 Series	400 series					>45
Bright	☆	◆	☆	◆							◆

☆ = Best Performance ◆ = Acceptable



Technical Information

Nomenclature	324	Carbide	
End Mill Finishes and Their Applications	326	Operating Parameters, Variable Index	
Speeds and Feeds	327	Style CEM-V-4 (R and B), CEM-V2-5R	333
Operating Parameters, HSS and Cobalt	329	Style CEM-HPDE-5, CEM-EMS (-3 and -5)	334
Operating Parameters, PM Plus™, HSS & Cobalt	331	Style CEM-AM (2 and 3)	335
End Mill Selection and Use	332	Style CEM-R (S and A)	336
		Style CEM-V3-7R	336
		Cutting Data	338
		Regrinding End Mills	339

End Mill Nomenclature

An end mill is a straight or tapered shank milling cutter which extends or projects, unobstructed, from the milling machine spindle. It is one of the most versatile of cutting tools, capable of milling, drilling, reaming, planing, shaping, contour cutting, and more. Improvements in cutting efficiency, through both design and material changes, have increased the usage of this style tool over time.

Axial Relief

The relief measured in the axial direction between a plane perpendicular to the axis at the cutting edge and the relieved surface.

Clearance (Secondary Relief)

The additional space provided behind the relieved land to eliminate undesirable contact between the mill and work piece.

Cutting Edge

The leading edge of the cutter tooth.

Flute

The chip space between the back of one tooth and the face of the following tooth.

Gash

Secondary cuts on a mill to provide chip room.

Hand of Cut

Right Hand, RH: When viewed from the cutting end of the mill, a counterclockwise rotation of the end mill is required in order to cut. Most end mills are right hand.

Left Hand, LH: When viewed from the cutting end of mill, a clockwise rotation of mill is required to cut.

Heel

The back edge of the relieved land.

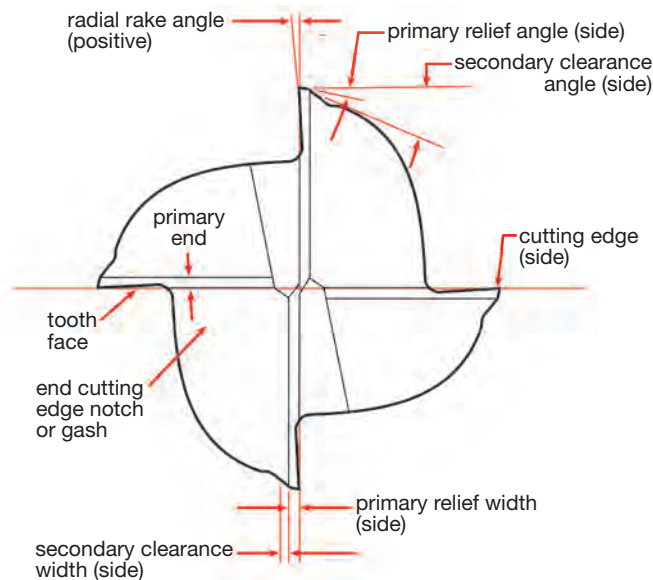

TECHNICAL High Speed Steel

Helix Angle

The cutting edge angle which a helical cutting edge makes with a plane containing the axis of a cylindrical mill. When viewed from the cutter end of the mill, the flute will move clockwise for a right hand helix.

Helical Rake

The helical rake at a given point on the flute face is the angle between the tool axis and a tangent plane at the given point.

Hook

A concave condition of a tooth face. The rake of a hooked tooth face must be determined at a given point.

Land

Used to define the width of a specified surface.

Length of Cut

The effective axial length of the peripheral cutting edge which has been relieved to cut

Primary Relief

The relief measured in the axial direction between a plane perpendicular to the axis at the cutting edge and the relieved surface.

Primary Relief

The relief immediately behind the cutting edge.

Rake

The angular relationship between the tooth face or a tangent to the tooth face at a given point and a reference plane or line.

Radial Rake

The angle between the tooth face and a radial line passing through the cutting edge in a plane perpendicular to the cutting axis.

Relief

The result of the removal of tool material behind or adjacent to the cutting edge to provide clearance and prevent rubbing.

Relief Angle

The angle formed between a relieved surface and a given plane tangent to the axis at the cutting edge or to a point on the cutting edge.

Shank

The projecting portion of a cutter which locates and drives the cutter from the machine spindle.

Tooth Face

The surface of the tooth on which the chip impinges.

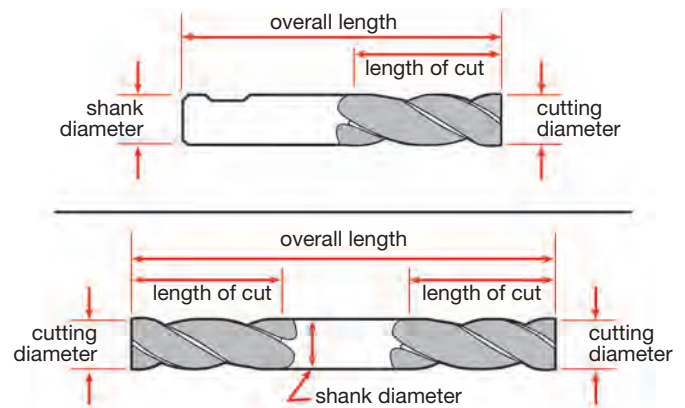
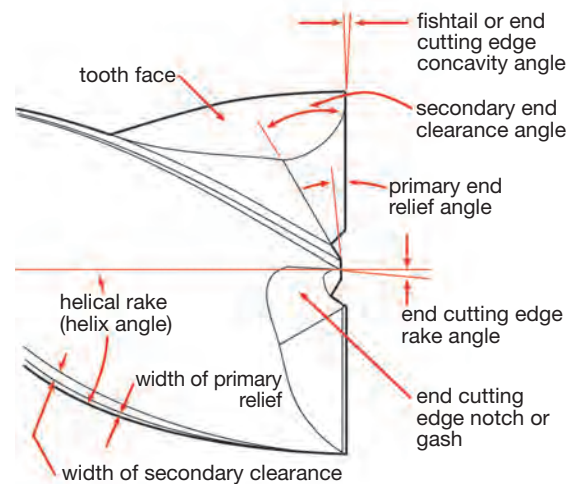

Center Cutting End View

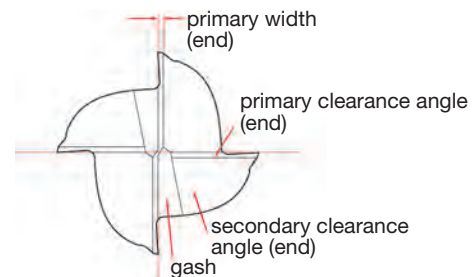

End Mill Finishes and Their Applications

Cleveland's cutting tools with TiN or TiCN coatings provide exceptional performance benefits. Coatings are matched with designs which are intended for aggressive material removal with significant increases in tool life and machining rates.

- Coatings reduce heat and abrasion to increase tool life.
 - The increased lubricity of the coating surface reduces material adhesion and built-up edge, enabling even higher feed rates.
 - Coatings reduce the amount of torque required for machining to allow more efficient use of equipment.
 - Increase machining speeds to achieve optimum performance when using Cleveland coatings.
- **Straw finish**
 - bronze color
 - for general machining
 - operate at conventional cobalt speeds and heavier feed rates.
 - **TiN (titanium nitride) coating**
 - gold color
 - intended for aggressive machining
 - increase machining speed 25% to 30% versus bright speeds
 - **TiCN (titanium carboni tride) coating**
 - blue-gray color
 - for very aggressive machining of stainless steels and non-ferrous materials
 - extremely hard, wear resistant
 - increase machining speeds 35% to 50% versus bright speeds
 - **TiAlN (titanium aluminum nitride) coating**
 - violet/blue-gray color
 - for aggressive machining of stainless steels, high alloy carbon steels, nickel-based high-temperature alloys, and titanium alloys
 - increase machining speeds 75% to 100% versus bright speeds.



Reducing Vibration & Chatter: When chatter arises it tends to be self-sustaining until the problem is corrected. This condition causes poor finish on the part and will damage and significantly reduce the life of end mills. Carbide end mills are peculiarly susceptible to damage.

A common source of chatter is the machining of corners. As the end mills enters the corner the percentage of engagement increases the number of teeth in the cut. This drastically increases the cutting forces, causing chatter. Using circular interpolation and producing a bigger corner radius than the part print calls for and then going back and removing the remaining stock with a smaller end mill using circular interpolation will reduce the tendency to chatter.

When experiencing chatter problems, the basic reflex action is the reduction of cutting forces. This can be done by:

- (1) Reducing the number of flutes.
 - (2) Decreasing the chip load per tooth by reducing the feed or increasing the speed or RPM.
 - (3) Reducing the axial or radial depth of cut.
- Even though these steps can and will reduce chatter, slowing down the cutting process is not always the best course of action and reducing the chip load can be detrimental to the cutter.

Better first steps are to improve rigidity and stability:

- (1) Use a larger end mill with a larger core diameter.
- (2) Use end mills with reduced clearance or a small circular margin.
- (3) Use the shortest overhang from spindle nose to tip of tool.
- (4) Use stub length end mills where possible.
- (5) Use balanced tool holders.
- (6) Rework fixture to hold the work piece more securely.
- (7) Reprogram the cutter path shifting cutting forces into stiffer portions of the work piece.
- (8) Look for sweet spots in spindle speeds then adjust feed accordingly.

Speeds and Feeds

Speeds and feeds are the most important factors to consider for best results in milling. Improper feeds and speeds often cause low production, poor work quality, and unnecessary damage to the cutter. Too high a speed or too light a feed leads to rapid wear and dulling of the cutter, reducing tool life.

In milling, **speed** is measured in peripheral feet per minute. Oftentimes, speed is referred to as cutting speed, surface speed, or peripheral speed. The relationship of peripheral speed to the diameter of the end mill and the rotational speed of the machine spindle are indicated in the table on page 201.

Feed is normally measured and stated in inches per minute (IPM). It is, as shown on page 201, the product of the number of cutting teeth in the end mill x the feed per tooth x the revolutions per minute. In establishing operating conditions, all feed rates should be calculated from the chip load or feed per tooth. The individual cutting tooth must be able to sustain the load or feed applied to it without fracturing, regardless of the number of teeth in the mill. Because feed per tooth affects thickness, it is a very important factor in tool life.

The highest possible feed per tooth will usually give longer tool life between grinds and greater production per grind. Excessive feeds may overload the mill teeth and cause breakage or chipping of the cutting edge. Reasonable safe starting feeds for end mills under 0.5000" diameter will range from 0.0002 to 0.002 inches per tooth. For end mills equal to or greater than 0.5000" diameter, starting feeds will range from 0.002 to 0.003 inches per tooth.

Milling Corrective Actions

Trouble	Corrective Action
lack of rigidity	increase speed, decrease feed
excessive abrasion of the tool	decrease speed, increase feed
chipping of the cutting edge	decrease feed per tooth
burning of the cutting edge	decrease speed
chatter	use other combinations of speed and feed

Starting Points

All recommended speeds and feeds are suggested starting points. These may be increased or decreased depending upon variables, such as finish desired, condition of the milling machine, magnitude of the cut, rigidity of the part, use of coolant, power available, etc. Consider these points when choosing starting speeds and feeds.

Adjusting Starting Speeds and Feeds

Speed Adjustments

Use lower speeds for:	Use higher speeds for:
hard materials	softer materials
tough materials	better finishes
abrasive materials	small diameter mills
heavy cuts	light cuts
minimum tool wear	frail work piece or set-ups
maximum mill life	maximum production rates
	non metallic

Feed Adjustments

Use higher feeds for:	Use lighter feeds for:
heavy roughing cuts	light and finishing cuts
rigid set-ups	frail set-ups
easy to machine work materials	hard to machine work materials
rugged heavy duty mills	deep slots
high tensile strength materials	frail and small diameter mills
coarse tooth mills	low tensile strength materials
abrasive materials	

Technical Information

To Find...	Known Values	Formulae
peripheral cutting speed – SFM	mill diameter, D rotational speed RPM	$SFM = 0.262 \times RPM \times D$ $SFM \text{ estimated} = (RPM \times D) / 4$
rotational speed – RPM	peripheral cutting speed, SFM mill diameter, D	$RPM = SFM / (0.262 \times D)$ $RPM \text{ estimated} = (4 \times SFM) / D$
machine feed rate - IPM	rotational speed, RPM number of flutes (Teeth), T feed per tooth, IPT	$IPM = T \times IPT \times RPM$
feed per tooth - IPT	machine feed rate, IPM rotational speed, RPM number of teeth, T	$IPT = IPM / (RPM \times T)$
feed per revolution - IPR	machine feed rate, IPM	$IPR = IPM / RPM$
cutting power input - HP	width of cut, WOC depth of cut, DOC machine feed rate, IPM workpiece material power constant, K	$HP = WOC \times DOC \times IPM \times K$

Power Constants* for Use in Power Calculations

Work Material	K (Constant)	Work Material	K (Constant)	Work Material	K (Constant)
Aluminum	.03	High Temp. Alloys		High Tensile Alloys	
Magnesium	.03	Ferritic	.17	180,000 - 220,000 psi	.20
Copper	.05	Austenitic	.20	220,000 - 260,000 psi	.25
Brass	.04	Nickel Base	.25	260,000 - 300,000 psi	.33
Bronze	.05	Cobalt Base	.25	Titanium	
Cast Irons		Steel		under 100,000 psi	.13
Ferritic	.07	up to 150 Brinell	.14	100,000 - 135,000 psi	.17
Pearlitic	.10	up to 300 Brinell	.17	135,000 psi & over	.25
Chilled	.17	up to 400 Brinell	.20	Stainless Steel	
Malleable Iron	.10	up to 500 Brinell	.25	Free Machining	.10
				Others	.17

*Horsepower required to remove one cubic inch of material per minute assuming a 60% power efficiency at the spindle nose and a 25% allowance for dulling of the end mill.

Definition of Symbols and Measurement Units

Attribute	Symbol	Measurement Unit
cutting speed	SFM	surface feet per minute
rotational speed	RPM	revolutions per minute
end mill diameter	D	inches
feed per tooth	IPT	inches per tooth
machine feed rate	IPM	inches per minute
feed per revolution	IPR	inches per revolution
cutting power input	HP	horsepower
power constant	K	horsepower/cubic inch/ minute
width of cut	WOC	inches
depth of cut	DOC	inches
number of teeth	T	—



Technical Information

Speed and Feed Data in Selected Materials – Regular HSS and Cobalt HSS End Mills

Material	Heat-Resistant Cobalt Base Alloys, High Tensile Steels (50-55C)	Heat-Resistant Austenitic Alloys, High Tensile Steels (46-50C)	Heat-Resistant Nickel Base Alloys, High Strength Stainless Steels, High Strength Titanium Alloys	High Strength Stainless Steels, High Tensile Steels (40-46C) Medium Strength Titanium Alloys	Heat-Resistant Ferritic Base Alloys, Medium Strength Stainless Steels, Unalloyed Titanium Tool Steels (30-40C)
End Mill Style	Cobalt HSS HSS 2 or more flute	Cobalt HSS HSS 2 or more flute	Cobalt HSS HSS 2 or more flute	Cobalt HSS HSS 2 or more flute	HSS 2 or more flute
Speed <i>all diameters</i>	5-10 SFM	10-15 SFM	15-20 SFM	20-40 SFM	40-60 SFM (all diameters)

mill diameter	Speed	Feed	Speed	Feed	Speed	Feed	Speed	Feed	Speed	Feed
	RPM	Chip Load per tooth	RPM	Chip Load per tooth	RPM	Chip Load per tooth	RPM	Chip Load per tooth	RPM	Chip Load per tooth
1/16	*	*	*	*	*	*	1222-2444	.0002-.0005	2444-3667	.0002-.0005
3/32	*	*	*	*	611-815	.0002-.0005	815-1629	.0002-.0005	1629-2750	.0002-.0005
1/8	*	*	*	*	456-611	.0002-.0005	611-1222	.0002-.0005	1222-1833	.0002-.0005
3/16	*	*	204-306	.0002-.0005	306-407	.0002-.0005	407-815	.0002-.0005	815-1222	.0002-.0005
1/4	76-153	.0002-.0010	153-230	.0002-.0010	229-306	.0002-.0010	306-611	.0002-.0010	611-917	.0002-.0010
5/16	61-122	.0002-.0010	122-183	.0002-.0010	183-244	.0002-.0010	244-489	.0002-.0010	489-733	.0002-.0010
3/8	51-102	.0002-.0010	102-153	.0002-.0010	153-203	.0002-.0010	203-407	.0005-.0020	407-611	.0005-.0020
7/16	44-88	.0005-.0010	88-132	.0005-.0010	131-175	.0005-.0020	175-349	.0005-.0020	349-524	.0005-.0020
1/2	38-76	.0005-.0010	76-115	.0005-.0010	115-153	.0005-.0020	153-306	.0005-.0030	306-458	.0010-.0030
9/16	34-68	.0005-.0020	68-104	.0005-.0020	104-136	.0005-.0020	136-272	.0005-.0030	272-412	.0010-.0030
3/8	31-61	.0005-.0020	61-92	.0005-.0020	92-122	.0005-.0020	122-244	.0010-.0040	244-367	.0010-.0040
11/16	28-56	.0005-.0020	56-84	.0005-.0020	84-111	.0005-.0020	111-222	.0010-.0040	222-337	.0010-.0040
3/4	26-51	.0005-.0020	51-76	.0005-.0020	76-102	.0010-.0040	102-203	.0010-.0040	203-306	.0010-.0040
13/16	24-47	.0010-.0030	47-71	.0010-.0030	71-94	.0010-.0040	94-189	.0010-.0040	189-284	.0010-.0040
7/8	22-44	.0010-.0030	44-65	.0010-.0030	65-87	.0010-.0040	87-175	.0010-.0040	175-262	.0020-.0060
15/16	20-40	.0010-.0030	40-62	.0010-.0030	62-81	.0010-.0040	81-163	.0010-.0040	163-246	.0020-.0060
1	19-38	.0010-.0030	38-58	.0010-.0030	58-76	.0010-.0040	76-153	.0020-.0060	153-229	.0020-.0060
1-1/8	34	.0015-.0040	34-51	.0015-.0040	51-68	.0015-.0050	68-136	.0020-.0060	136-204	.0020-.0060
1-1/4	31	.0015-.0040	31-46	.0015-.0040	46-61	.0015-.0050	61-122	.0020-.0060	122-183	.0020-.0060
1-3/8	28	.0015-.0040	28-42	.0015-.0040	42-55	.0015-.0050	55-111	.0020-.0060	111-167	.0030 +
1-1/2	26	.0015-.0040	26-38	.0015-.0040	38-51	.0020 +	51-102	.0030 +	102-153	.0030 +
1-5/8	24	.0020 +	35	.0020 +	35-47	.0020 +	47-94	.0030 +	94-141	.0030 +
1-3/4	22	.0020 +	32	.0020 +	32-43	.0020 +	43-87	.0030 +	87-131	.0030 +
1-7/8	20	.0020 +	30	.0020 +	30-40	.0030 +	40-81	.0030 +	81-122	.0030 +
2	19	.0020 +	29	.0030 +	29-38	.0030 +	38-76	.0030 +	76-115	.0030 +
2-1/8	18	.0030 +	28	.0030 +	36	.0030 +	36-72	.0030 +	72-108	.0030 +
2-1/4	17	.0030 +	26	.0030 +	34	.0030 +	34-68	.0030 +	68-102	.0030 +
2-3/8	16	.0030 +	25	.0030 +	32	.0030 +	32-64	.0030 +	64-97	.0030 +
2-1/2	15	.0030 +	23	.0030 +	30	.0030 +	30-61	.0030 +	61-92	.0030 +
2-5/8	15	.0030 +	22	.0030 +	29	.0030 +	29-58	.0030 +	58-88	.0030 +
2-3/4	14	.0030 +	21	.0030 +	28	.0030 +	28-56	.0030 +	56-83	.0030 +
2-7/8	14	.0030 +	20	.0030 +	27	.0030 +	27-53	.0030 +	53-80	.0030 +
3	13	.0030 +	19	.0030 +	26	.0030 +	26-51	.0030 +	51-76	.0030 +

* For small diameter applications in materials harder than 46C consult Cleveland Technical Support.

TECHNICAL
High Speed Steel and Cobalt



Technical Information

Speed and Feed Data in Selected Materials – Regular HSS and Cobalt HSS End Mills (continued)

Material	Machine Steel Hard Brass & Bronze Electrolytic Copper Mild Steel Forming	Cast Iron Mild Steel Half-Hard Brass and Bronze	Brass and Bronze Alloyed Aluminum Abrasive Plastics	Aluminum Plastics Wood
End Mill Style	HSS 2 or more flute	HSS surface treatment helpful in cast iron 2 or more flute	High Helix HSS 1 to 6 flutes	High Helix HSS 1 to 6 flutes
Speed <i>all diameters</i>	60-80 SFM	80-100 SFM	100-200 SFM	200-600 SFM

mill diameter	Speed	Feed	Speed	Feed	Speed	Feed	Speed	Feed
	RPM	Chip Load per tooth	RPM	Chip Load per tooth	RPM	Chip Load per tooth	RPM	Chip Load per tooth
1/16	3667-4888	.0002-.0005	4888-6111	.0002-.0005	6111-12222	.0002-.0005	12222 +	.0002-.0005
3/32	2750-3259	.0002-.0005	3259-4073	.0002-.0005	4073-8146	.0002-.0005	8146 +	.0002-.0005
1/8	1833-2440	.0002-.0010	2440-3056	.0002-.0010	3056-6112	.0002-.0010	6112 +	.0002-.0010
3/16	1222-1625	.0002-.0010	1625-2037	.0002-.0010	2037-4074	.0002-.0010	4074-12222	.0002-.0010
1/4	917-1222	.0005-.0020	1222-1528	.0005-.0020	1528-3056	.0005-.0020	3056-9168	.0005-.0020
5/16	733-978	.0005-.0020	978-1222	.0005-.0020	1222-2444	.0005-.0020	2444-7332	.0005-.0020
3/8	611-815	.0010-.0030	815-1019	.0010-.0030	1019-2038	.0005-.0030	2038-6114	.0005-.0020
7/16	524-698	.0010-.0030	698-873	.0010-.0030	873-1746	.0005-.0030	1746-5238	.0005-.0020
1/2	458-611	.0010-.0030	611-764	.0010-.0030	764-1528	.0005-.0030	1528-4584	.0005-.0020
9/16	412-543	.0010-.0040	543-678	.0010-.0040	678-1356	.0005-.0040	1356-4071	.0005-.0030
3/8	367-489	.0010-.0040	489-611	.0010-.0040	611-1222	.0005-.0040	1222-3666	.0005-.0030
11/16	337-444	.0010-.0040	444-555	.0010-.0040	555-1110	.0005-.0040	1110-3330	.0005-.0030
3/4	306-407	.0010-.0040	407-509	.0020-.0060	509-1018	.0010-.0060	1018-3054	.0010-.0040
13/16	284-379	.0020-.0060	379-469	.0020-.0060	469-938	.0010-.0060	938-2814	.0010-.0040
7/8	262-349	.0020-.0060	349-436	.0020-.0060	436-872	.0010-.0060	872-2616	.0010-.0040
15/16	246-326	.0020-.0060	326-407	.0020-.0060	407-814	.0010-.0060	814-2442	.0010-.0040
1	229-306	.0020-.0060	306-382	.0020-.0060	382-764	.0020 +	764-2292	.0020 +
1-1/8	204-272	.0020-.0060	272-340	.0030 +	340-680	.0020 +	680-2040	.0020 +
1-1/4	183-244	.0030 +	244-306	.0030 +	306-612	.0020 +	612-1836	.0020 +
1-3/8	167-222	.0030 +	222-278	.0030 +	278-556	.0020 +	556-1668	.0020 +
1-1/2	153-204	.0030 +	204-255	.0030 +	255-510	.0030 +	510-1530	.0020 +
1-5/8	141-188	.0030 +	188-235	.0030 +	235-470	.0030 +	470-1410	.0020 +
1-3/4	131-175	.0030 +	175-218	.0030 +	218-436	.0030 +	436-1308	.0020 +
1-7/8	122-163	.0030 +	163-204	.0030 +	201-408	.0030 +	408-1224	.0030 +
2	115-153	.0030 +	153-191	.0030 +	191-382	.0030 +	382-1146	.0030 +
2-1/8	108-144	.0030 +	144-179	.0030 +	179-358	.0030 +	358-1074	.0030 +
2-1/4	102-136	.0030 +	136-170	.0030 +	170-340	.0030 +	340-1020	.0030 +
2-3/8	97-128	.0030 +	128-161	.0030 +	161-322	.0030 +	322-966	.0030 +
2-1/2	92-122	.0030 +	122-153	.0030 +	153-306	.0030 +	306-918	.0030 +
2-5/8	88-116	.0030 +	116-145	.0030 +	145-290	.0030 +	290-870	.0030 +
2-3/4	83-111	.0030 +	111-139	.0030 +	139-278	.0030 +	278-834	.0030 +
2-7/8	80-106	.0030 +	106-132	.0030 +	132-264	.0030 +	264-792	.0030 +
3	76-102	.0030 +	102-127	.0030 +	127-254	.0030 +	254-762	.0030 +

TECHNICAL

Speed and Feed Data in Selected Materials – PM Plus™ Powder End Mills

Material	Hardness BHN	Surface Feet per Minute SFM				Chip Load Per Tooth by Cutting Diameter			
		Bright	TiN	TiCN	TiAlN	1/8"	1/4"	1/2"	1"
Titanium	300	60-75	75-94	90-113	120-150	.0015	.0025	.0050	.0070
Annealed Alloys	340	30-45	38-56	45-68	60-90	.0010	.0020	.0040	.0060
Sol. Trtd. & Aged	400	15-30	19-38	23-45	30-60	.0007	.0015	.0020	.0040
High Temp. Alloys	300	30-45	38-56	45-68	60-90	.0020	.0025	.0040	.0060
Inconel, Monel, Hastelloy	400	10-24	13-30	15-36	20-48	.0015	.0020	.0030	.0050
Tool Steels	370	40-55	50-69	60-83	80-110	.0005	.0007	.0012	.0020
Tool Steels	450	20-30	25-38	30-45	40-60	.0003	.0005	.0007	.0010
Free Machining Steel	200	90-120	113-150	135-180	180-240	.0010	.0020	.0040	.0060
Alloyed & UnAlloyed	275	75-90	94-113	90-135	150-180	.0007	.0012	.0030	.0050
Alloy Steels - Med. to Hard	400	40-50	50-63	60-75	80-100	.0010	.0015	.0020	.0040
Stainless Steel									
Work Hardening	Various	55-75	69-94	83-113	110-150	.0005	.0007	.0012	.0020
Precipitation Hardening	Various	35-50	44-63	53-75	70-100	.0005	.0007	.0012	.0020
Copper Alloys									
Long Chip	Various	250-500	313-625	375-750	500-1000	.0050	.0025	.0050	.0080
Short Chip	250	180-240	225-300	270-360	360-480	.0010	.0020	.0040	.0060
Aluminum, Soft Gummy		750	938	1125	1500	.0020	.0030	.0060	.0100
Heat Treated Aluminum Alloys Aircraft Alloys	Various	1000	1250	1500	2000	.0020	.0030	.0060	.0100

Speed and Feed Data in Selected Materials – PM Plus and Cobalt HSS Roughing End Mills

	Surface Feet per Minute SFM			Chip Load Per Tooth by Cutting Diameter			
	Bright	TiCN	TiAlN	1/4"	1/2"	3/4"	1"
Coarse Profile Cobalt Roughers							
Steel < 20 HRc	98	230	262	.0006	.0022	.0033	.0039
Steels 20-30 HRc	82	180	197	.0005	.0019	.0032	.0039
Cast iron	82	180	197	.0005	.0019	.0032	.0039
Fine Profile Cobalt Roughers							
Steel < 20 HRc	96	230	295	.0006	.0021	.0031	.0043
Steels 20-30 HRc	82	131	246	.0005	.0019	.0028	.0038
Steels 32-40 HRc	49	131	147	.0005	.0016	.0024	.0031
Stainless Steels	33	82	115	.0004	.0016	.0024	.0031
Titanium > 40 HRc	33	82	82	.0004	.0016	.0024	.0031
PM Roughers							
Steels < 32 HRc	59	157	180	.0005	.0019	.0032	.0033
Steels 32-42 HRc	49	98	157	.0006	.0017	.0029	.0034
Cast Iron < 180 HR	59	157	180	.0005	.0019	.0032	.0033
Cast Iron > 180 HR	49	98	157	.0006	.0017	.0029	.0034
Stainless Steels	39	72	98	.0005	.0016	.0028	.0031
Titanium > 40 HRc	32	59	82	.0004	.0016	.0028	.0030
High-Temp Alloys	22	36	49	.0006	.0017	.0029	.0034
	Surface Feet per Minute SFM		Chip Load Per Tooth by Cutting Diameter				
	Bright	TiCN	1/8"	1/4"	1/2"	1"	2"
Aluminum, soft/gummy	250-500	400-2500	.005"	.007"	.010"	.012"	.015"
Aluminum alloys < 10% silicon	250-750	500-3250	.005"	.007"	.010"	.012"	.015"
Aluminum alloys > 10% silicon	N/R	N/R	N/R	N/R	N/R	N/R	N/R
Copper alloys, long chipping	250-500	350-1500	.005"	.007"	.009"*	.012"	.015"
Copper alloys, short chipping	150-250	200-1250	.003"	.006"	.008"	.010"	.013"

*for Style 538, .010" is recommended.

Note: All the speeds and feeds shown are suggested starting points. They may be increased or decreased, dependent upon such variables as finish desired, condition of milling machine, magnitude of cut, coolant, etc. In many cases they may be increased slightly. The above speeds and feeds are applicable for slotting cuts, one (1) diameter deep. For deeper slotting cuts or cavity applications, feeds should be decreased.

Choosing the correct tool material

Cleveland end mills are available in a variety of tool materials: regular high speed steel, premium cobalt high speed steel, and PM/Plus powder metal cobalt high speed steel for higher production rates. The choice of tool material will depend on the following factors:

- Machinability of the workpiece
- Hardness and structure of the workpiece
- Shape and conditions of the workpiece
- Number of work pieces to be processed.

High speed steel end mills have low initial cost and general purpose versatility. End mills of high speed steel with cobalt have proven most effective in titanium alloys, alloy steels, Rc-40-50, high strength stainless steels, and thermal and heat resistant materials such as nickel or cobalt base alloys. PM/Plus end mills which use a special cobalt high speed steel coupled with a heat treatment and special mechanical designs, are capable of greater than normal feed rates and longer tool life in these same material groups.

Consider the number of flutes

To determine selection of either a two flute or a multiple flute end mill, several basics need to be considered.

- Type of cut
- Chip space required
- Production rate desired
- Surface finish required

Two fluted end mills have greater chip handling capacity than multiple fluted end mills. In order for an end mill to axially plunge-cut (drill), it must be manufactured as a center cutting tool. All two flute and multiple flute tools are available as center cutting end mills.

When two flute end mills and multiple flute end mills are run at the same feed rate (inches per minute), multiple flute end mills may produce finer finishes and longer tool life than two flute end mills, owing to a lighter chip load per tooth. Some caution must be exercised to insure that the chip load does not become so light as to cause excessive wear. Generally for production runs where either a two flute or multiple flute end mill would be applicable, it is more economical to use the multiple flute end mill.

Roughing versus finishing end mills

Roughing end mills are designed to be used in a variety of materials and to remove more cubic inches of material in the same period of time than conventional end mills. In order to achieve these rates of material removal, as well as to obtain full tool life, the feed rates employed must be heavier than with conventional end mills.

Selection of cutting fluids

Coolants control the temperatures of the end mill and the work, and provide a lubricant between the end mill, the chip and the workpiece. The proper type and application of coolant will protect the end mill cutting edges from damage, prevent deformation of the work piece through overheating, and improve finish by allowing cool, clean chip formation and efficient chip disposal.

The theory that a copious flow of coolant (or even total immersion of the workpiece in the coolant) is the surest way to provide proper cooling and lubrication, is not necessarily true. Recent tests have shown that multiple streams or jets of coolant, directed at strategic locations of the end mill rotating in or against the work, have greater cooling effects than a slow-moving copious flow.

The optimum application of coolant is achieved by the use of coolant feeding end mills. These end mills are designed and manufactured to meet your specific need.

When using coolant, care should always be taken to insure that coolant lines are clean and free of obstructions, and that the coolant is both clean and free of fines.

No matter how well the cutting fluid is directed between the end mill and the work, a dull end mill will generate more heat than can be dissipated by adequate cooling. Proper cutting fluid application will protect a sharp cutting edge to insure maximum tool life per grind. An interrupted flow of cutting fluid can cause rapid damage to the cutting edges in a few revolutions of the end mill.

It is always wise to consult a cutting fluid supplier when experiencing problems of an unusual nature.

A cutting fluid or coolant is required when using high speed steel end mills for milling steel. For milling with high speed end mills, water emulsified cutting oil generally is considered the least expensive and most applicable coolant for nearly all materials except those that are milled dry. Some of the harder steel forgings and die steels may be milled with somewhat better results when mineral or lard oils, or sulfurized oils are used. Plastics and cast iron should be milled dry or with a jet of air, while aluminum and aluminum alloys are best milled with water emulsified cutting oil, either in a properly directed jet stream, or in a mist.

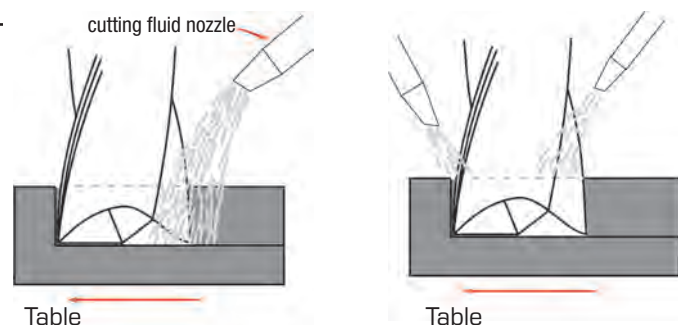

Technical Information

Operating Parameters

Variable Index Style: **CEM-V-4***

*4R or 4B

Tolerances for Solid Carbide End Mills

Cutting Diameter: 1/32" through 1": +0.000 -0.002

Shank Diameter: h6

Formula: Regular and Stub Length

Side milling axial = 1.5 x D Side milling radial = 0.5 x D Slotting axial = 1 x D

Material	Speed sfm	feed per tooth (inches)								
		5/32	3/16	1/4	5/16	3/8	1/2	5/8	3/4	1
easy to cut stainless steel (303)	340	0.0010	0.0012	0.0016	0.0020	0.0024	0.0026	0.0028	0.0028	0.0030
moderately difficult to cut stainless (304)	290	0.0008	0.0010	0.0014	0.0018	0.0020	0.0022	0.0024	0.0026	0.0028
difficult to cut stainless steels (316L)	240	0.0006	0.0010	0.0012	0.0016	0.0018	0.0020	0.0022	0.0024	0.0024
soft steels (1020)	600	0.0010	0.0012	0.0016	0.0024	0.0024	0.0028	0.0030	0.0031	0.0039
titanium alpha beta alloys (Ti6Al4V)	200	0.0005	0.0006	0.0008	0.0012	0.0012	0.0016	0.0018	0.0020	0.0028
gray cast iron (GG)	600	0.0010	0.0012	0.0016	0.0024	0.0024	0.0028	0.0030	0.0031	0.0039

Formula: Long Length

Side milling axial = 1.3 x D Side milling radial = 0.2 - 0.3 x D Slotting axial = 0.3 - 0.5 x D

Material	Speed sfm	feed per tooth (inches)								
		5/32	3/16	1/4	5/16	3/8	1/2	5/8	3/4	1
easy to cut stainless steel (303)	340	0.0009	0.0011	0.0014	0.0018	0.0022	0.0023	0.0025	0.0025	0.0027
moderately difficult to cut stainless (304)	290	0.0007	0.0009	0.0013	0.0016	0.0018	0.0020	0.0022	0.0023	0.0025
difficult to cut stainless steels (316L)	240	0.0005	0.0009	0.0011	0.0014	0.0016	0.0018	0.0020	0.0022	0.0022
soft steels (1020)	600	0.0009	0.0011	0.0014	0.0022	0.0022	0.0025	0.0027	0.0028	0.0035
titanium alpha beta alloys (Ti6Al4V)	200	0.0005	0.0005	0.0007	0.0011	0.0011	0.0014	0.0016	0.0018	0.0025
gray cast iron (GG)	600	0.0009	0.0011	0.0014	0.0022	0.0022	0.0025	0.0027	0.0028	0.0035

Technical Information

Operating Parameters

Variable Index Style: **CEM-V2-5R**

ENHANCED GEOMETRY

Formula:

Side milling axial = 1.5 x D Side milling radial = 0.5 x D Slotting axial = 1 x D

Material	Speed sfm	chip load per tooth (inches)							
		3/16	1/4	5/16	3/8	1/2	5/8	3/4	1
medium and high carbon steels >0.3% C	600-750	0.0015	0.0021	0.0023	0.0026	0.0028	0.0030	0.0031	0.0039
alloy steels and tool steels <330HB, <35HRc	600-700	0.0011	0.0017	0.0020	0.0023	0.0028	0.0030	0.0031	0.0039
alloy steels and tool steels 340-450 HB, 36-48 HRc	525-625	0.0010	0.0015	0.0016	0.0020	0.0028	0.0030	0.0031	0.0039
austenitic stainless steel 302, 303, 304	350-445	0.0011	0.0017	0.0020	0.0023	0.0022	0.0024	0.0026	0.0028
austenitic stainless steel 316, 316L	225-315	0.0009	0.0013	0.0016	0.0019	0.0020	0.0024	0.0024	0.0024
austenitic stainless steel duplex	190-230	0.0008	0.0010	0.0014	0.0015	0.0020	0.0024	0.0024	0.0024
cast iron, gray GG	520-660	0.0014	0.0022	0.0025	0.0030	0.0028	0.0030	0.0031	0.0039
ductile and maleable cast iron CGI < 80 KSI	430-660	0.0009	0.0013	0.0018	0.0019	0.0028	0.0030	0.0031	0.0039
nickel-based heat-resistant alloys	100-160	0.0004	0.0007	0.0011	0.0015	0.0016	0.0019	0.0023	0.0028
alpha-beta titanium alloys Ti6Al4V	195-240	0.0008	0.0010	0.0014	0.0015	0.0016	0.0018	0.0020	0.0028

Technical Information

Material	Hardness		Speed		Chip Load per Tooth		
	Brinell	HRC	Range	SFM	1/32" - 1/4"	1/4" - 1/2"	1/2" - 1"
low alloy steels	<220 HB	<19	Low High	600 750	.0005 .0010	.0010 .0020	.0020 .0030
medium alloy steels 01 to 07, W1 to W3, M1 to M3, T1 to T5, A2 to A3, S1 to S7, P2 to P3	225-286	20-30	Low High	600 750	.0003 .0005	.0005 .0010	.0010 .0015
high alloy steels M4 to M7, T6 to T15, D2 to D7, A4 to A7, P4	294-371	31-40	Low High	525 625	.0003 .0005	.0005 .0010	.0008 .0015
stainless steels 200/300 series	135-275	<28	Low High	250 350	.0005 .0010	.0010 .0020	.0020 .0030
stainless steels 400/500 series	135-330	<35	Low High	340 400	.0003 .0005	.0008 .0010	.0010 .0015
nickel-based alloys	140-475	<32-50	Low High	100 160	.0005 .0010	.0010 .0015	.0015 .0040
titanium alloys	110-450	<48	Low High	195 240	.0005 .0010	.0010 .0030	.0025 .0050
inconel	140-475	<48	Low High	100 160	.0005 .0010	.0010 .0015	.0015 .0030
aluminum, low silicon	—	—	Low High	800 1600	.0030 .0040	.0040 .0060	.0060 .0080

Higher values for surface speed should be used for radial depths of cut less than 25% of the diameter. Lower values for surface speed should be used for radial depths of cut greater than 25% of the diameter. The above recommendations are for axial lengths of cut not to exceed 1 times the cutter diameter for profiling and .5 times the diameter for slotting. Recommended speeds above are for uncoated tools only and should be adjusted when using

coated tools. Generally, speeds can be increased by the following factors: TiCN-coated tools – 20-25% increase; TiAlN-coated tools – 40-50% increase. The above speeds are a recommended starting point only. If the tool is working well, without vibrations or significant noise, increase the SFM in 5-10% increments. Ultimate speeds will depend upon setup conditions. Higher or lower parameters may be required to achieve optimum conditions.

Stainless Steel / Exotic Material

Applications:

- Designed for cutting applications involving excessive mechanical stress.
- Ideally suited for use in stainless steel and exotics such as hastalloy, waspalloy, and inconel.
- 3 flute square end for pocketing, slotting, or roughing.
- 3 flute ball nose gives enhanced surface finish in contour cutting and rapid chip removal in plunge cutting.
- 5 flute design for profiling and finishing applications.

Features and Benefits:

- Maximized strength due to increased cross-sectional area in the core and flute body.
- Combination of micro grain carbide substrate with high-performance coatings.
- Achieve 50% greater chip loads and 20% to 40% higher speeds than conventional end mills.

Technical Information
Formula:

$$\text{RPM} = (\text{SFM} \times 3.82) / \text{tool diameter}$$

$$\text{IPM} = \text{number of flutes} \times \text{RPM} \times \text{chip load per tooth}$$

Type of Cut	Aluminum Alloys 6061-T6, 7075-T6, 440, 356, 380, 61300	Depth of Cut % of Tool diameter	Speed sfm	End Mills Diameter Chip Load per Tooth					
				1/4"	3/8"	1/2"	5/8"	3/4"	1"
medium radial 1.0 x dia depth	< 32 HRC > 32 HRC	30% x dia. radial	1200 + 600 +	.0045 .0036	.0071 .0057	.0100 .0080	.0123 .0098	.0149 .0119	.0200 .0160
heavy radial 1.0 x dia depth	< 32 HRC	50% x dia. radial	1200 +	.0036	.0057	.0080	.0098	.0119	.0160
medium radial 2.0 x dia depth	< 32 HRC > 32 HRC	30% x dia. radial	1200 + 600+	.0045 .0036	.0071 .0057	.0100 .0080	.0123 .0098	.0149 .0119	.0200 .0160
heavy radial 2.0 x dia depth	< 32 HRC	50% x dia. radial	1200 +	.0036	.0057	.0080	.0098	.0119	.0160
finishing medium radial	< 32 HRC > 32 HRC	< 25% of dia.	1200 + 600 +	.0045 .0036	.0071 .0057	.0100 .0080	.0123 .0098	.0149 .0119	.0200 .0160
finishing light radial	< 32HRC	< 10% of dia.	1200 +	.0045	.0071	.0100	.0123	.0149	.0200
finishing	< 32 HRC > 32 HRC	< .010 radial depth	1200 + 600+	.0054 .0045	.0086 .0071	.0120 .0100	.0147 .0123	.0178 .0149	.0240 .0200

This chart represents starting points based on a coated tool. Reduce rates up to 50% when using an uncoated tool.

These speed and feed rates are suggested as general guidelines. Machine type, horsepower, spindle speed limitations, toolholding and workholding devices all may

impact a cutting tool's ability to perform properly. Greenfield Industries is not responsible for tool failure, part damage, or injury that may be caused by following these general recommendations.

Aluminum and nonferrous material

Applications:

- Delivers superior performance, providing increased tool life and improved part finish.
- Concentric margins stabilize the tool in the cut and reduce chatter at elevated speeds.
- Greater resistance to chipping with increased feed and speed rates over conventional carbide tools.
- Design incorporates rake enhancements in the flute for improved chip flow and higher feed rates at high and low spindle speeds.
- Tool design eliminates excess pressure that causes chip packing.

Features and Benefits:

- 2 flute square end offers excellent performance in roughing and finishing, in ramp cutting and in plunging.
- 2 flute ball nose designed for contouring aluminum, copper, and other non-ferrous materials.
- 3 flute square end gives superior surface finishes without sacrificing metal removal rates in high-speed slotting, profiling, and ramping.

Material	Hardness		SFM			Chip Load per Tooth	
	Brinell	HRc	Bright	TiCN	TiAlN	1/4" to 1/2"	1/2" - 1"
low and plain carbon, alloy, and tool steels	<220 HB	<19	-	325 - 500	430 - 575	.0015 - .0030	.0030 - .0045
plain carbon, alloy and tool steels	225 - 286 294 - 371	20 - 30 31-40	-	215 - 375 180 - 280	350 - 430	.0015 - .0030 .0011 - .0021	.0030 - .0045 .0021 - .0032
austenitic stainless steels 200 and 300 series	135 - 275	<28	-	215 - 440	250 - 500	.0010 - .0025	.0025 - .0040
ferritic, martensitic, 400/500 series and PH stainless steels	135 - 330	<35	-	190 - 375	225 - 430	.0015 - .0030	.0030 - .0045
aluminum, low silicon and other non-ferrous alloys	50 -150	600	2000	2400 - 2500	-	.0020 - .0038	.0038 - .0077
aluminum, high silicon			600 - 2000	720 - 2500	-	.0018 - .0035	.0035 - .0071

Operating Parameters

Style: **CEM-V3-7R**

The new Cleveland CEM-V3-7R High Performance 7 Flute Variable Index End Mills were specifically designed to excel at HEM Trochoidal Milling. High Efficiency Milling (HEM) is a style of machining that features high axial depths of cut and low radial depths of cut. One common type of HEM is Trochoidal Milling. The modified cutting depths in Trochoidal Milling allow the CNC Machine to implement a spiral machining pattern that reduces tool load and wear in a part. This is accomplished by allowing the end mill to alternate between repeated short cutting times within a part and longer spiral rotations outside of the part. Trochoidal Milling uses a much smaller tool diameter than one would typically use in slotting applications. By implementing this smaller tool, a wider slot in the part is created, allowing additional space for the chips produced and the spiral tool path of the end mill.

The process of Trochoidal Milling developed as a result of the theory of chip thinning. This theory holds that tools have an ideal chip load that creates chips with the perfect size and width. To prevent chips from thinning in the cut outside of this ideal range, it is best to maintain a higher chip load in the milling operation to maintain this ideal chip thickness. This need to maintain a higher and ever changing chip load while milling a part requires that HEM Trochoidal Milling only be attempted on CNC Machines with Trochoidal Milling capabilities.

Benefits:

- Lower heat and cycle times for machining applications.
- Better end mill tool life and accuracy.
- The ability to use one tool for multiple applications and different slots.

Challenges:

Trochoidal Milling must be used on a CNC Machine capable of running the changing feed rates necessary in this process with software adept at generating HEM Tool Paths.

continued on next page

Technical Information

Material	Peripheral/Roughing HEM		Speed (SFM)	Feed (IPT)						
	Axial DOC	Radial DOC		3/16	1/4	3/8	1/2	5/8	3/4	1
Gray Cast Iron	≤ 3 x D	.1 x D	400	0.002	0.003	0.005	0.007	0.009	0.010	0.014
	3 x D - 4 x D	.08 x D		0.002	0.003	0.004	0.006	0.007	0.009	0.012
Malleable Cast Iron	≤ 3 x D	.08 x D	400	0.002	0.002	0.004	0.005	0.007	0.008	0.011
	3 x D - 4 x D			0.001	0.002	0.003	0.004	0.006	0.007	0.009
Low Carbon Steels	≤ 3 x D	.08 x D	500	0.002	0.003	0.005	0.007	0.009	0.011	0.015
	3 x D - 4 x D		450	0.002	0.003	0.004	0.006	0.007	0.010	0.012
Medium Carbon Steels	≤ 3 x D	.08 x D	450	0.002	0.003	0.005	0.007	0.008	0.010	0.014
	3 x D - 4 x D			0.002	0.003	0.004	0.006	0.007	0.009	0.012
Tool and Die Steels	≤ 3 x D	.08 x D	400	0.002	0.003	0.004	0.006	0.008	0.009	0.012
	3 x D - 4 x D			0.002	0.002	0.004	0.005	0.006	0.008	0.01
Austenitic Stainless Steels, FeNi Alloys, 300 Series Stainless Steels	≤ 3 x D	.08 x D	400	0.002	0.003	0.004	0.006	0.008	0.009	0.012
	3 x D - 4 x D	.07 x D	450	0.002	0.002	0.004	0.005	0.006	0.008	0.01
Martensitic and Ferritic Stainless Steels	≤ 3 x D	.08 x D	450	0.002	0.003	0.005	0.007	0.009	0.011	0.015
	3 x D - 4 x D			0.002	0.003	0.004	0.006	0.007	0.009	0.012
Precipitation Hardening Stainless Steels	≤ 3 x D	.08 x D	450	0.002	0.003	0.004	0.006	0.007	0.009	0.012
	3 x D - 4 x D	.07 x D	400	0.002	0.002	0.003	0.005	0.006	0.007	0.01
Titanium Alloys	≤ 3 x D	.1 x D	400	0.001	0.002	0.003	0.004	0.005	0.006	0.008
	3 x D - 4 x D	.08 x D		0.001	0.001	0.002	0.003	0.004	0.005	0.007
Difficult to Machine Titanium Alloys	≤ 2.5 x D	.08 x D	350	0.001	0.002	0.003	0.004	0.005	0.006	0.008
	2.5 x D - 4 x D	.06 x D	300	0.001	0.001	0.002	0.003	0.004	0.005	0.006
Hi Temp Alloys	≤ 1.5 x D	.07 x D	100	0.003	0.004	0.007	0.009	0.011	0.014	0.018
	1.5 x D - 3 x D	.06 x D		0.002	0.003	0.005	0.007	0.009	0.011	0.015

Material	Finishing		Speed (SFM)	Feed (IPT)						
	Axial DOC	Radial DOC		3/16	1/4	3/8	1/2	5/8	3/4	1
Gray Cast Iron	3 x D	.015 x D	450	0.001	0.001	0.002	0.002	0.003	0.003	0.005
Malleable Cast Iron			350	0.001	0.001	0.001	0.002	0.002	0.003	0.004
Low Carbon Steels			400	0.001	0.001	0.002	0.002	0.003	0.004	0.005
Medium Carbon Steels			400	0.001	0.001	0.001	0.002	0.003	0.003	0.005
Tool and Die Steels			350	0.001	0.001	0.001	0.002	0.002	0.003	0.004
Austenitic Stainless Steels, FeNi Alloys, 300 Series Stainless Steels			400	0.001	0.001	0.002	0.002	0.003	0.004	0.005
Martensitic and Ferritic Stainless Steels			400	0.001	0.001	0.001	0.002	0.003	0.003	0.005
Precipitation Hardening Stainless Steels			350	0.001	0.001	0.001	0.002	0.002	0.003	0.004
Titanium Alloys			350	0.001	0.001	0.001	0.001	0.002	0.002	0.003
Difficult to Machine Titanium Alloys			2 x D	.01 x D	300	0.001	0.001	0.001	0.001	0.001
Hi Temp Alloys	100	0.001			0.002	0.003	0.004	0.006	0.007	0.009

TECHNICAL
High Speed Steel

Technical Information

Material	Hardness		Surface feet per minute	Chip Load per Tooth									
	Brinell	HRC		1/16"	1/8"	3/16"	1/4"	5/16"	3/8"	1/2"	5/8"	3/4"	1"
low and plain carbon, alloy and tool steels	<220 HB	<19	Low 270	.0004	.0006	.0010	.0015	.0020	.0025	.0030	.0035	.0040	.0045
			High 360										
plain carbon, alloy, and tool steels	225-286	20-30	Low 180	.0004	.0006	.0010	.0015	.0020	.0025	.0030	.0035	.0040	.0045
			High 270										
austenitic stainless steels 200 and 300 series	294-371	31-40	Low 135	.0003	.0004	.0007	.0011	.0014	.0018	.0021	.0025	.0028	.0032
			High 180										
ductile and malleable cast iron	135-275	<28	Low 180	.0002	.0004	.0006	.0010	.0015	.0020	.0025	.0030	.0035	.0040
			High 315										
cast iron (gray)	120-320	<35	Low 160	.0003	.0004	.0007	.0011	.0014	.0018	.0021	.0025	.0028	.0032
			High 270										
nickel-based high-temperature alloys	120-220	<18	Low 315	.0008	.0012	.0020	.0030	.0040	.0050	.0060	.0070	.0080	.0090
			High 450										
low-silicon aluminum & other non-ferrous alloys	220-320	19-34	Low 225	.0005	.0007	.0012	.0018	.0024	.0030	.0036	.0042	.0048	.0055
			High 315										
cobalt-based high-temperature alloys	50-150	—	Low 720	.0006	.0010	.0016	.0024	.0032	.0040	.0048	.0560	.0064	.0072
			High 900										
nickel-based high-temperature alloys	150-425	<45	Low 30	.0004	.0006	.0010	.0015	.0020	.0025	.0030	.0035	.0040	.0045
			High 45										
cobalt-based high-temperature alloys	140-300	<32	Low 45	.0002	.0004	.0006	.0009	.0012	.0015	.0018	.0021	.0024	.0027
			High 90										
nickel-based high-temperature alloys	300-475	32-50	Low 40	.0002	.0004	.0006	.0009	.0012	.0015	.0018	.0021	.0024	.0027
			High 70										

Higher values for surface speed should be used for radial depths of cut less than 25% of the diameter. Lower values for surface speed should be used for radial depths of cut greater than 25% of the diameter.

The above recommendations are for axial lengths of cut not to exceed 1 times the cutter diameter for profiling and .5 times the diameter for slotting.

Recommended speeds above are for uncoated tools only and should be adjusted when using coated tools. Generally, speeds can be increased by the following factors:

- TiCN-coated tools – 20-25% increase
- TiAlN-coated tools – 40-50% increase

The above speeds are a recommended starting point only. If the tool is working well, without vibrations or significant noise, increase the SFM in 5-10% increments. Ultimate speeds will depend upon setup conditions. Higher or lower parameters may be required to achieve optimum conditions.

Applications

- Use in general milling applications in medium to low-carbon steels, cast iron, non-ferrous light metals, and plastics.
- Double-end end mills economically increase productivity.
- 2 flute end mills are generally used for plunging, slotting, and heavy peripheral cuts.
- 3 flute end mills provide a compromise between the chip clearance of a 2 flute tool and the rigidity and wear resistance of a 4 flute tool; especially useful for many slotting operations.
- 4 flute end mills are most commonly used in profiling and in harder materials; stiffer construction results in minimal deflection. They also provide good surface finishes and wear-resistant characteristics for excellent size control.

Features and Benefits:

- 10% cobalt submicron grain carbide substrate.
- 30° right-hand spiral, right-hand cut helix designed for maximum chip clearance.
- 2, 3, and 4 flute configurations available.
- Square end and ball nose end geometries available.
- Multiple lengths in select styles and sizes.
- TiAlN-coated tools available in most styles.

TECHNICAL High Speed Steel

In every manufacturing plant today, large and small, an effective, organized end mill regrinding program is essential. No matter how large or small the end mill usage may be, an organized regrinding system will pay dividends in greater production per end mill.

General Information

End mills should be removed from the machine at the end of a predetermined production run, or when dull. If possible, a predetermined amount of stock should be removed on dull end mills (normal stock removal is .005" or .010" for each regrind) and color coding or size etching might be marked on the end mill to indicate its size. After several regrinds (this, too, can be predetermined) the end mill will tend to lose its effective rake angle and flute depth, and, at this point, the end mill must be scrapped.

Charts and data for the correct relief angles, relief widths, and rake angles for regrinding end mills are shown on pages 268 and 270.

After regrinding and inspection, all end mills should be dipped in rust-preventative oil, and, if suitable cartons are not available, they should be dipped in plastic coating for the full flute length. They should be stored in their original container, in separate bins or wooden containers. Small wooden containers that can be carried about are usually better than ordinary bin storage, as rough handling, in some cases, ruins more cutting edges than the actual milling operation.

The basic requirements for efficient end mill regrinding are:

- Tool grinding equipment in good condition.
- Adequate information for particular applications with reference to correct reliefs and rake angles.
- A workable tool conservation program.
- Adequate storage facilities and efficient handling techniques.

Nothing decreases the usable tool life of an end mill more than continued use of a dull end mill. The cutting action of a dull end mill is such that all the shearing qualities are gone and the material being milled is actually pushed on ahead of the individual cutting edges. This results in drawing the temper of the individual high-speed steel cutting edges, poorer finishes and accelerated wear. Continued use of a dull end mill makes it necessary to remove much more stock at regrinding to make the end mill usable once again. In the case of carbide end mills excessive dullness will chip and crater the cutting edges and will often cause breakage.

The point in the milling operation at which an end mill begins to dull can be determined in several ways. A dull end mill begins to spring or chatter, causes finishes to become poorer, and glazes or smears some materials. In addition, a wear land begins to form on the top of each individual cutting edge. Many milling machine operators can determine the first signs of end mill dulling by the sound of the cutting action, or by slight variations in machine vibrations.

Generally, an end mill is ready for resharpening when a wear land is visible on the top of the cutting edge. For smaller diameter end mills, and when milling some of the harder, ferrous materials, a wear land of approximately .005 may be used as an indication of the maximum allowable wear prior to resharpening. When using larger diameter end mills, and when milling in other classes of materials, a wider wear land may be used as an end point prior to regrinding.

In the final analysis, the many variables of each individual end mill application will determine the amount of cutting edge wear or degree of end mill dullness allowable before regrinding.

Regrinding Equipment

The tool cutter grinders on the market today are extremely versatile, and are capable of end mill regrinding between centers or off-the-shank. Tool and cutter grinders specifically designed for this type of work are easy to set up, operate and maintain, and versatile enough to regrind many types of cutting tools other than end mills. For a large volume of regrinding work some facilities utilize NC or CNC grinding equipment which maintains uniformity of reground mills at each regrinding.

Wheel Selection for Regrinding High Speed Steel (HSS) End Mills

Efficient end mill regrinding is possible without the necessity of stocking a large inventory of various wheel types. For general purpose regrinding, aluminum oxide wheels of 46 to 80 grit are usually satisfactory, although, for finer finishes finer grit wheels may be used. When using wheels with a grit finer than 80, and particularly when resharpening thin cutting edges, approximately .002" should be the maximum amount of stock removal. Heavier cuts than .002" with fine grit wheels usually cause wheel loading and cutting edge burning. CBN wheels are recommended for minimum heat generation and may allow greater stock removal on roughing operations.



Wheel Selection for HSS End Mills (continued)

Two basic types of wheels may be used: plain or cupped. The cutting edge sections shown below are those which will be produced on the end mill cutting edges by each of these wheels. For a conventional type of regrinding, cup-shaped wheels are often preferred. This preference is caused by the fact that regrinding with a plain wheel tends to leave a high heel portion on the cutting edge, which might cause drag. If the heel portion is too high, it must be cleared also, requiring an additional regrinding setup and operation. Then too, the relief ground on an end mill cutting edge with a cupped wheel is easier to measure, as this type of regrinding leaves a flat, angular relief.

Effect of Wheel Shape on End Mill Relief Angle
Cup Wheel versus Plain Wheel

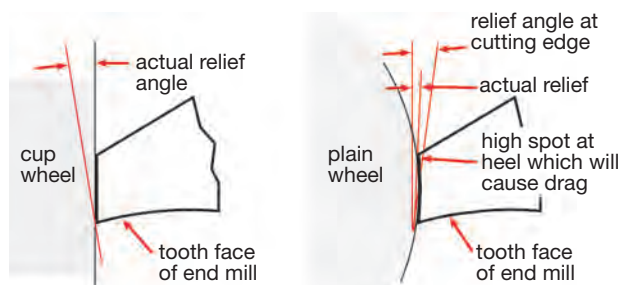

In actual regrinding, after the flute finger and wheel-to-flute location have been set, each flute is traversed past the wheel, taking a light cut and maintaining a steady motion. After the first light cut, the end mill should be measured to make certain that no taper is being added to the end mill. After the proper amounts of stock have been removed, to re-sharpen the end mill completely, a very light cut should be taken on all flutes, to make certain that roundness and concentricity is maintained.

In choosing the correct relief for the milling job at hand, it is best to regrind end mills to produce just enough primary relief to eliminate drag. Drag will cause friction and overheating of the cutting edges, and usually some buildup of the material on the heel of the primary relief. On the other hand, too much relief will cause the end mill to chatter and the cutting edges will tend to deteriorate rapidly. Too much relief is the least objectionable of the two choices, but the ideal situation is to have just enough relief. The amount of secondary clearance necessary is usually dependent on the size of the end mill, the width of the primary relief, and the feeds being used. For example, if the feed per tooth per revolution is .004", the heel of the secondary clearance must be at least .005" below the cutting edge. The table below lists the approximate side relief for various end mills.

The best re-sharpening procedure is to first regrind the primary relief until all of the wear has been removed, taking care to avoid excessive diameter loss. Next, the secondary clearance is ground to bring the primary relief land to the desired widths. After grinding the secondary clearance, it is often desirable that the primary relief surfaces be given a light finish grind to refine the cutting edges. To minimize runout, this light finishing cut should be made at one machine sitting, going completely around the end mill.

Regrinding the Sides

Producing the correct relief angle on an end mill is accomplished by establishing the proper location of the wheel and the end mill. On NC or CNC equipment, this relationship is established through use of a probe or other locating type device. On tool and cutter grinding equipment, a finger or flute rest is used as the locating device. The location of the flute finger should be such that it is mounted in proximity to the wheel. It must be adjustable but not attached to the table. The flute finger may be mounted on the table only when regrinding straight fluted end mills, and then its use is confined to that of an indexing finger.

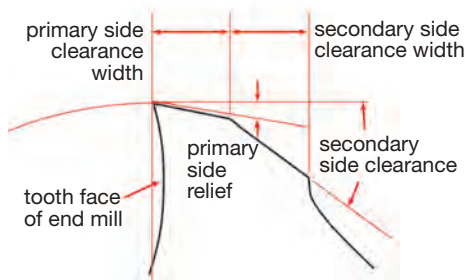

Side Relief Angles

	End Mill Diameter	Primary Clearance	Primary Width	Secondary Clearance Angle
HSS and Cobalt End Mills	1/8" - 1/4"	13° - 10°	.005" - .011"	26°
	1/2" - 3/4"	10° - 9°	.012" - .024"	17°
	1" - 2"	9° - 7°	.020" - .035"	15°
HSS High-Helix End Mills	1/8" - 1/4"	14°	.017" - .013"	27°
	1/2" - 3/4"	13° - 12°	.015" - .027"	21°
	1" - 2"	11° - 10°	.022" - .040"	18°
PM Plus	1/8" - 1/4"	22° - 18°	.004" - .013"	29°
Powder Metal End Mills	1/2" - 3/4"	16° - 12°	.010" - .018"	22°
	1" - 2"	11° - 10°	.015" - .030"	19°

Checking Relief Angles

The universally accepted method of checking relief angles on the sides of end mills is to mount the end mill to rotate about its axis. Position a dial indicator above or to the side of the end mill, (with the dial indicator finger at right angles to the axis of the end mill being checked) and measure the indicator drop in thousandths of an inch on the primary relief.

This method, shown in the illustration, may be used for any type of side relief, be it dish shaped, flat, or radial. The measurable width of primary relief may be any predetermined amount.

The table below shows the amount of indicator drop for various primary relief angles when the cutting edge of the end mill is moved or rotated the tabulated measured primary width.

Off-hand side relief regrinding of end mills for any milling application should never be done under any circumstance.

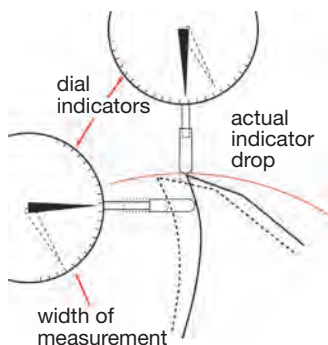
Regrinding the Ends

Regrinding of the ends of end mills does not differ too much from regrinding of the sides, in that the basic principles still apply. However the method of grinding varies in that nearly all regrinding is done off of the shank. The task at hand is to reproduce an end that may be center cutting, square end, ball nose or square end with a corner radius. Almost any of the tool or cutter grinders may be used to produce accurate regrinding and re-notching of the square end style and some are built to also permit accurate reproduction of ball and radius ends. NC or CNC equipment can be programmed to achieve all of the required end configurations during regrinding.

Whenever possible, end notching or gashing cuts should be produced with grinding wheels which have corner radii so as to reduce stress concentration at the bottom of the gash. End tooth notch angles should produce about 0° to 5° positive axial rake.

In re-sharpening of end teeth the first step is always the removal of the wear on the end teeth and at the corner intersection of the end and peripheral teeth. Particular care must be taken so that all of the corner wear is removed.

Once the wear has been removed, it then is a matter of using the proper set-up and wheel shapes to produce the desired center cutting end configuration capability. On center cutting end mills one or more teeth must be cleared to cut to or past center. A gash is normally provided on the center cutting teeth to aid chip removal and prevent chip packing in the center of the end mill.

Ball end mills present re-sharpening problems due to their relieved radius form and roughly spherical form of the secondary clearance. Most users will end up using a machine to generate the cleared form and then hand clear the secondary and trailing heel. Care must always be exercised in regrinding the ends regardless of their shape to avoid generating any chip pockets.

Primary relief land widths of end teeth will be approximately 1-1/2 to 3 times that recommended for peripheral teeth. The table on the next page is a listing of typical details for clearing the ends of end mills.

Primary end relief is usually increased for softer materials and decreased as the hardness of the work material increases or the machinability of the work material decreases. Primary end relief angles should also be increased on small diameter mills used for plunge-cutting.

continued on next page

Primary Relief Angle for Side Teeth of End Mills

End Mill Diameter	Measured Primary Relief Width	Indicator Drop in Measured Primary Relief Width					
		4°	6°	8°	10°	12°	15°
1/8	1/64	.0000	.0000	.0002	.0008	.0015	.0021
3/16	1/64	.0000	.0003	.0009	.0014	.0020	.0028
1/4	1/64	.0001	.0007	.0012	.0018	.0023	.0031
5/16	1/64	.0003	.0009	.0014	.0019	.0025	.0033
3/8	1/64	.0004	.0010	.0015	.0021	.0026	.0034
7/16	1/64	.0005	.0011	.0016	.0022	.0027	.0035
1/2	1/64	.0006	.0012	.0017	.0022	.0028	.0036
5/8	1/32	.0006	.0017	.0028	.0039	.0050	.0066
3/4	1/32	.0009	.0020	.0029	.0042	.0052	.0069
7/8	1/32	.0011	.0022	.0032	.0043	.0054	.0070
1	1/32	.0012	.0023	.0034	.0045	.0056	.0072
1-1/8	1/32	.0013	.0024	.0035	.0046	.0057	.0073
1-1/4	3/64	.0015	.0032	.0048	.0064	.0080	.0105
1-3/8	3/64	.0017	.0033	.0050	.0066	.0082	.0106
1-1/2	3/64	.0018	.0034	.0051	.0067	.0083	.0107
1-3/4	3/64	.0020	.0037	.0053	.0069	.0085	.0109
2	3/64	.0022	.0038	.0054	.0071	.0087	.0111
2-1/4	1/16	.0027	.0048	.0070	.0092	.0113	.0145
2-1/2	1/16	.0028	.0050	.0072	.0093	.0115	.0147
2-3/4	1/16	.0029	.0051	.0073	.0095	.0116	.0148
3	1/16	.0031	.0052	.0074	.0096	.0117	.0150

Regrinding the Ends (continued)

Primary end relief is usually increased for softer materials and decreased as the hardness of the work material increases or the machinability of the work material decreases. Primary end relief angles should also be increased on small diameter mills used for plunge-cutting.

Secondary End Clearance

Secondary end clearance depends on the material being milled and the type of operation. Some tracer milling operations, requiring comparatively heavy in-feeds, will necessitate additional secondary clearance, whereas shallow traversing cuts would require less secondary end clearance.

In addition, milling of the higher density steels require less secondary end clearance, but aluminum and other non-ferrous milling applications require increased secondary end clearances. In most cases, off hand grinding of secondary end clearances on end mills is the quickest and most economical method, as no absolute degree of accuracy is required. For combination notching and secondary end clearing of end mills, however, where the side of the wheel makes contact with the cutting face of one of the end teeth, care must be exercised, and some users prefer to notch and clear end teeth in one grinding operation, by machine.

Regrinding End Mill Tooth Rake Angles

While correct relief angles on end mill teeth are essential for economical milling, too often little attention is given to maintaining the correct rake angles. Rake angles or hook angles are shown below.

As the illustration shows, the term rake is commonly used when referring to a comparatively straight cutting face. The rake or hook angle formed by the side cutting faces of an end mill is often referred to as radial rake.

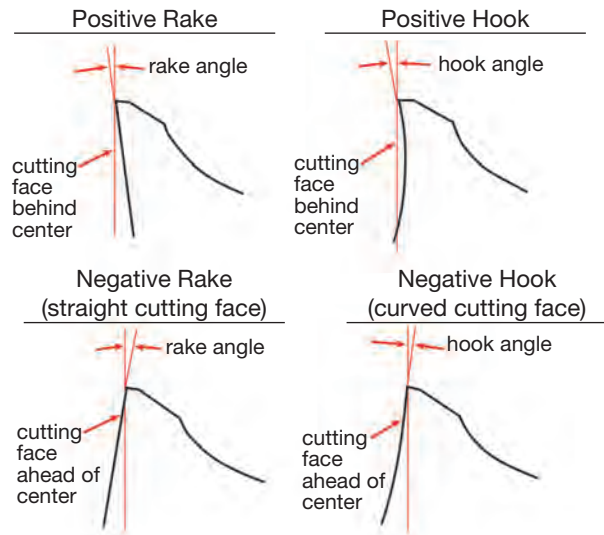

End Relief Angles

	End Mill Diameter	Primary Clearance	Primary Width	Secondary Clearance Angle
HSS, Cobalt and PM Plus End Mills	1/8" - 1/4" 1/2" - 3/4" 1" - 2"	6° - 8°	.025" - .035" .035" - .050" .045" - .075"	25° - 30°
HSS High-Helix End Mills	1/8" - 1/4" 1/2" - 3/4" 1" - 2"	8° - 10°	.025" - .045" .035" - .060" .050" - .100"	30° 23° 23°

Most end mills are manufactured with a hook rather than a rake because the curved cutting face aids in curling and ejecting the chips. The proper rake angle is governed by the material being cut and the material from which the end mill is made. Most high-speed steel end mills usually have generous positive rake angles on the side cutting teeth, whereas tungsten carbide types of end mills are usually manufactured with lower positive or even negative rake angles. Softer materials usually will allow higher rake angles to be used, whereas the harder, tougher materials require lower rake angles.

Radial rake is not to be confused with axial or helical rake. Axial rake is that angle formed about the axis of the mill by a straight cutting edge at one given point, whereas helical rake is that helical angle formed around the axis of the mill by the cutting edge.

Axial rake is formed by a straight angular cutting edge, and is not constant, whereas helical rake is formed by a helical cutting edge and is constant. Helix angles or helical rake angles for end mills may range, from 0° up to 60°. For general purpose milling, helix angles of 25° to 35° are the most popular.

Regrinding Tooth Rake Angles (continued)

During manufacturing a specific radial rake is built into each end mill type based upon its intended area of work material application. As an end mill is reground on the outside diameter, there is a continual reduction in the radial rake present in the tool, resulting in higher cutting forces and generally shorter tool life. An end mill generally can only be reduced in cutting diameter by about 10% to 15% of the original diameter before the mill must be discarded or the correct radial rake reground into face of the flute.

Width of Tooth Face being Measured

rake angle	indicator drop in thousandths of an inch			
	1/32"	1/16"	3/32"	1/8"
1°	.0005	.0011	.0016	.0022
2°	.0011	.0022	.0034	.0044
3°	.0016	.0033	.0049	.0065
4°	.0022	.0044	.0066	.0087
5°	.0027	.0054	.0082	.0108
6°	.0033	.0065	.0099	.0131
7°	.0038	.0076	.0115	.0152
8°	.0044	.0087	.0132	.0174
9°	.0049	.0098	.0148	.0195
10°	.0055	.0109	.0165	.0217
11°	.0061	.0119	.0182	.0238
12°	.0066	.0130	.0200	.0260
15°	.0084	.0162	.0251	.0323
20°	.0114	.0227	.0341	.0455

Regrinding Radial Rake Angles

The practice of regrinding radial rake or hook angles on end mills of diameters below 1/2" is usually not economical, unless large quantities of the same size are involved. Thus the regrinding of radial rake is usually confined to end mills of larger sizes. There are three accurate methods of regrinding the rake angles in the helical flutes of an end mill.

1. Use of a tool room grinder with a spiral lead attachment.
2. Use of a fixture, mounted on a tool room grinder having a former (a bar grooved with the same lead as the end mill) which rotates the end mill at the correct helix angle as it moves forward into the grinding wheel.
3. Use of a properly programmed CNC grinder.

Inspecting Radial Rake Angles

The illustration shows one method of inspecting the radial hook or rake in the side tooth of an end mill, when the end mill is located in inspection centers or in an accurate horizontal spindle. This method measures the amount of rake of the tooth being measured in indicator drop. Convert this amount of indicator drop to the angular equivalent of the actual rake angle by reference to the table at left.

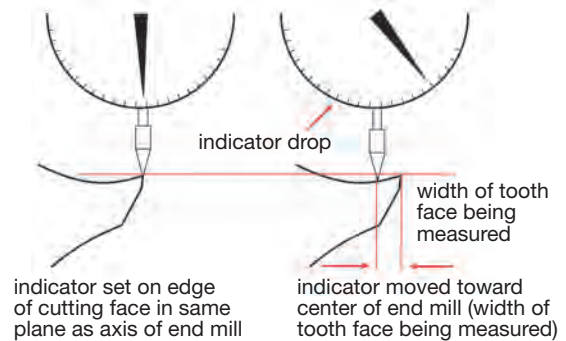

Sharpening Roughing End Mills

Roughing end mills are designed as form-relieved cutters, and as such, the OD wear is removed by grinding the radial rake face of the teeth and fillet of the flute. Generally this is accomplished on a tool and cutter grinding machine. If a roughing end mill is center or end cutting, the end teeth are re-sharpened the same way as end teeth on standard end mills.

A saucer-shaped grinding wheel, dressed to match the form of the flute face from OD to the fillet, is used. The grinding head is turned to an angle 1° to 3° greater than the helix angle of the mill. This will allow the leading edge of the wheel to hollow grind the rake face. (Typically the finished hook is 8° to 12°).

A tooth support finger or lead-generating device may be used to ensure that the proper lead is maintained. The support finger rides on the back of the tooth being sharpened, located below the form. Unless equal stock is removed from each rake face, the re-sharpened mill will have more radial run-out during use. Normally this should not prove to be a problem, provided enough stock is left on the roughed out part for finishing.

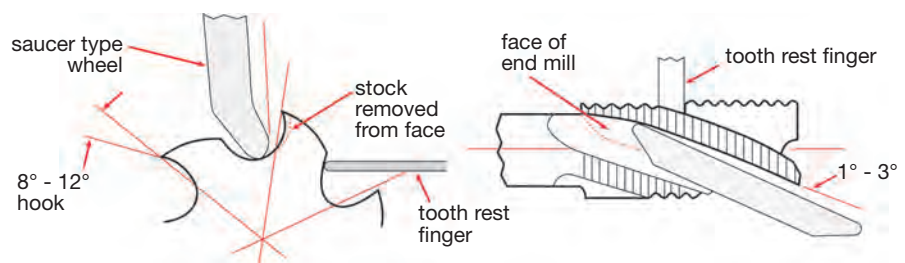

TECHNICAL High Speed Steel, PM, and Cobalt



Other Tool Product Index. 344

TECH TIPS

- Use Screw Extractors to Remove Broken Screws and Bolts. 345
- Ground Tool Bits. 346
- Drill and Reamer Blanks. 349

Other Tools

Other Tools					Tool Material				Application					
					HSS	Cobalt Carbide	TCT	Steel	Stainless	Cast Iron	Non-Ferrous	High-Temp Alloy	Hardened Steel	
		Type	Style	Page	Set									
Screw Extractor		Ezy-Out®	192	345	yes	•			•					
Tool Bits		Square	850	346		•			•					
		Square	855	346			•		•					
		Square	860	346			•		•					
		Square	3507	346			•			•				
		Rectangular	851	347			•			•				
		Rectangular	856	347			•		•					
		Rectangular	861	347			•		•					
		Rectangular	3517	347			•			•				
Cut-off Blades		General Purpose	852	348		•			•					
			857	348		•			•					
		Armstrong/Williams Holder	853	348		•			•					
Blanks		Oversize	902	349		•			•					
		Undersize	903	349		•			•					
Milling Cutter and Saws	 Style 305 Style 307 Style 321 Style 318 Style 326 Style 327	Side Milling	305	350		•			•					
		Staggered Tooth	307	350		•			•					
		Woodruff Key Seat	321	350		•			•					
		Screw Slot	318	351		•			•					
		Plain Metal	326	351		•			•					
		Side Chip Clearance	327	352		•			•					
		Metal Cases		Empty			352							

Index

Material Icons

Material Reference	Icon Reference	P		M		K		N	S		H
	Type	Steel (HRc)		Stainless Steel		Cast Iron (HRc)		Aluminum and Non-Ferrous	Hi-Temp Alloy		Hardened Steel (HRc)
	Hardness	Low Carbon	Alloy	Austenitic	Martensitic	PH	Gray		Nodular	Ni, Co, Fe Based Super Alloy	
		13-38	>38	16-38	> 38	300 Series	400 series				>45

Style: 192
**Ezy-Out®
Screw Extractor**
P K
**ANSI
SIZES**
**ALLOY
STEEL
SUBSTRATE**

extractor number	small end (in)	large end (in)	overall length (in)	screw size	pipe size	use this drill size	order number
#1	.054	.156	2.000	#8 - 1/4	--	5/64	192 C53651
#2	.080	.188	2.375	#12 - 5/16	--	7/64	C53652
#3	.125	.250	2.688	5/16 - 7/16	--	5/32	C53653
#4	.188	.328	2.875	7/16 - 9/16	--	1/4	C53654
#5	.250	.438	3.375	9/16 - 3/4	1/8, 1/4	9/32	C53655
#5-1/4	.343	.531	3.375	11/16 - 15/16	1/4	23/64	C53669
#6	.375	.594	3.750	3/4 - 1	3/8	13/32	C53656
#6-3/8	.468	.687	3.750	15/16 - 1-1/8	3/8	31//64	C53670
#7	.500	.750	4.125	1 - 1-3/8	1/2	17/32	C53657
#7-1/2	.593	.875	4.125	1-1/8 - 1-1/2	1/2	39/64	C53671
#8	.750	1.000	4.375	1-3/8 - 1-3/4	3/4	13/16	C53658
#9	1.000	1.281	4.625	1-3/4 - 2-1/8	1	1-1/16	C53659
#10	1.250	1.563	5.000	2-1/8 - 2-1/2	1-1/4	1-5/16	C53660
#11	1.500	1.875	5.625	2-1/2 - 3	1-1/2	1-9/16	C53661
#12	1.875	2.313	6.250	3 - 3-1/2	2	1-15/16	C53662

NOTE: Recommended drill size and extractor size shown above are for normal conditions. Unusual conditions will require the use of other size extractors and drills, depending on the length of the broken section and the depth of the hole. In general, use the largest possible screw extractor.

Sets
Style: 192
**Other Tools
Ezy-Out® Screw Extractor Set**

no. of pieces	sizes	order number
5	#1, 2, 3, 4, and 5	192 C00906
6	#1, 2, 3, 4, 5, and 6	C00907
3	#4, 5, and 6	C00909
4	#5, 5-1/4, 6-3/8, and 7-1/2	C00917
6	#5, 5-1/4, 6-3/8, 7-1/2, 8, and 9	C00918
4	#6, 7, 8, and 9	C00908
12	#1, 2, 3, 4, 5, and 6 plus drills 5/64", 7/64", 5/32", 1/4", 9/32", 13/32"	C00910

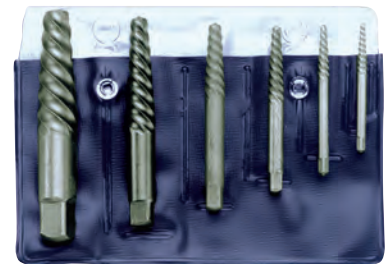
TECH TIPS
Use Screw Extractors to Remove Broken Screws and Bolts

Screw extractors are often used in maintenance departments, machine shops, garages, and workshops to remove broken screws, bolts, or other threaded parts.

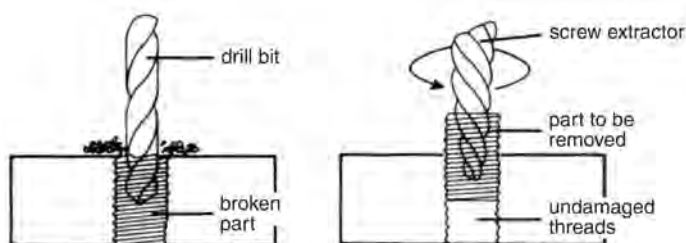
To remove a broken screw, follow this procedure.

- Drill a hole into the broken screw using the recommended drill size from the table above.
- Insert the proper screw extractor into the hole and start a counter-clockwise (left-hand) rotation using a tap wrench on the square on the shank.
- The extractor will grip the wall of the hole in the screw and back the screw out without damaging the threads.
- A penetrating oil can be helpful in removing rusty or corroded parts.

Other Tools

Tool Bits
Square



Styles: 850, 855, 860, 3507

Mo-Max® HSS

Style: 850

P K

ANSI SIZES HSS



Mo-Max® Cobalt

Style: 855

M P K

ANSI SIZES M42 Cobalt



Super Mo-Max® Cobalt

Style: 860

M S

ANSI SIZES M42 Cobalt HEAVY DUTY



Super Cle-Max® Cobalt

Style: 3507

S

ANSI SIZES T-15 SUBSTRATE HEAVY DUTY



order number

tool bit size		overall length	850	855	860	3507
fractional	(in)	(in)	M2 HSS	M42 Cobalt	M42 Cobalt	T15
1/8	.1250	2.500	C44505	C44536	C44567	-
3/16	.1875	2.500	C44509	C44540	C44571	C44671
1/4	.2500	2.500	C44513	C44544	C44575	C44672
5/16	.3125	2.500	C44514	C44545	C44576	C44673
3/8	.3750	3.000	C44516	C44547	C44578	C44674
7/16	.4375	3.500	C44518	C44549	C44580	C44675
1/2	.5000	4.000	C44520	C44551	C44582	C44676
5/8	.6250	4.500	C44522	C44553	C44584	C44677
3/4	.7500	5.000	C44525	C44556	C44587	C44678
7/8	.8750	6.000	C44527	C44558	C44589	-
1	1.0000	7.000	C44528	C44559	C44590	C44679
1-1/4	1.2500	9.000	C44530	C44561	C44592	-

Other Tools

TECH TIPS

Ground Tool Bits

- Mo-Max tool bits are designed for general-purpose work in moderate materials.
- Mo-Max Cobalt tool bits are ideal for general-purpose work in harder materials.
- Super Mo -Max Cobalt tool bits are designed for heavy-duty work in high-temp alloys.
- Super Cle-Max Cobalt tool bits are meant for the heaviest duty work in tough materials.



Styles: 851, 856, 861, 3517
Mo-Max® HSS
Style: 851

Mo-Max® Cobalt
Style: 856

Super Mo-Max® Cobalt
Style: 861

Super Cle-Max® Cobalt
Style: 3517

tool bit size fractional	width (in)	height (in)	overall length (in)	order number			
				851 M2 HSS	856 M42 Cobalt	861 M42 Cobalt	3517 T15
1/4 x 3/8	.250	.375	2.500	C44600	C44601	C44602	-
1/4 x 3/8	.250	.375	3.000	-	-	-	C44685
1/4 x 1/2	.250	.500	4.000	C44606	C44607	C44608	C44686
1/4 x 1/2	.250	.500	6.000	C44609	C44610	C44611	-
1/4 x 3/4	.250	.750	5.000	-	-	-	C44687
5/16 x 1/2	.313	.500	3.000	C44616	C44617	C44618	-
3/8 x 1/2	.375	.500	3.000	C44619	C44620	C44621	-
3/8 x 1/2	.375	.500	4.000	C44622	C44623	C44624	C44689
3/8 x 1/2	.375	.500	6.000	C44625	C44626	C44627	-
3/8 x 5/8	.375	.625	4.000	C44628	C44629	C44630	-
3/8 x 5/8	.375	.625	4.500	-	-	-	C44690
3/8 x 5/8	.375	.625	5.000	C44631	C44632	C44633	-
3/8 x 5/8	.375	.625	6.000	C44634	C44635	C44636	-
3/8 x 3/4	.375	.750	4.000	C44637	C44638	-	-
3/8 x 3/4	.375	.750	6.000	C44640	C44641	C44642	-
1/2 x 3/4	.500	.750	4.000	C44644	C44645	C44646	-
1/2 x 3/4	.500	.750	5.000	-	-	-	C44692
1/2 x 3/4	.500	.750	6.000	C44647	C44648	C44649	-
1/2 x 1	.500	1.000	7.000	-	-	-	C44693
1/2 x 1	.500	1.000	8.000	C44650	C44651	C44652	-
5/8 x 3/4	.625	.750	5.000	C44653	C44654	C44655	C44694
5/8 x 7/8	.625	.875	6.000	C44656	C44657	C44658	-
3/4 x 1	.750	1.000	6.000	C44659	C44660	C44661	-
3/4 x 1	.750	1.000	7.000	-	-	-	C44696
1 x 1-1/4	1.000	1.250	6.000	-	-	-	C44697

Cut-Off Blades

Styles: **852, 857**

Mo-Max® HSS

Style: **852**



This product is obsolete once inventory is depleted. Please call for availability.



Mo-Max® Cobalt

Style: **857**

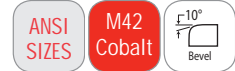

This product is obsolete once inventory is depleted. Please call for availability.



blade size fractional	nominal thickness (in)	nominal height (in)	overall length (in)	order number	
				852 M2 HSS	857 M42 Cobalt
1/16 x 1/2 x 4-1/2	.0625	.500	4.500	C44701	—
1/16 x 11/16 x 5	.0625	.688	5.000	C44703	C44704
1/16 x 13/16 x 6	.0625	.813	6.000	C44705	C44706
3/32 x 11/16 x 5	.0938	.688	5.000	C44709	C44710
1/8 x 11/16 x 5	.1250	.688	5.000	C44715	—
5/32 x 13/16 x 6	.1562	.813	6.000	C44721	—
3/16 x 13/16 x 6	.1875	.813	6.000	C44723	—
3/16 x 1 x 6-1/2	.1875	1.000	6.500	C44725	C44726
1/4 x 1 x 6-1/2	.2500	1.000	6.500	C44731	—

Cut-Off Blades for Armstrong and Williams Holders

Styles: **853**

Mo-Max® HSS



This product is obsolete once inventory is depleted. Please call for availability.



blade size fractional	nominal thickness (in)	nominal height (in)	overall length (in)	order number	fitting Armstrong holder no.	fitting Williams holder no.
				853 M2 HSS		
3/32 x 1/2 x 4-1/2	.0938	.500	4.500	C44740	19, 29L, 29R	—
3/16 x 1 x 6-1/2	.1875	1.000	6.500	C44748	23, 33L, 33R	N-23R, N-33R, N-33L

Other Tools

Style: 902
Reamer Blank
 Oversize

P K S

 ANSI
 SIZES

HSS

 Tolerance $+.0002/-0.000$

blank diameter	width (in)	height (in)	order number
			902
3/64	.0469	1.750	C19271
#51	.0670	2.000	C19288
1/8	.1250	2.750	C19335
5/32	.1562	3.125	C19355
3/16	.1875	3.500	C19377
7/32	.2188	3.750	C19398
1/4,E	.2500	4.000	C19416
5/16	.3125	4.500	C19449

Style: 903
Drill Blank
 Undersize

P K S

 ANSI
 SIZES

HSS

 Tolerance $+.0000/-0.0002$

blank diameter	width (in)	height (in)	order number
			903
#55	.0520	1.875	C19562
1/16	.0625	1.875	C19570
3/32	.0938	2.250	C19599
1/8	.1250	2.750	C19622
3/16	.1875	3.500	C19664
1/4,E	.2500	4.000	C19703
5/16	.3125	4.500	C19736
3/8	.3750	5.000	C19766
1/2	.5000	6.000	C19795

TECH TIPS
Drill and Reamer Blanks

- Ideal for use as drifts of dowel pins, for gauging purposes, and for making punches.
- Also can be used for round tool bits, countersinks, boring, or burring tools.

Side Milling Cutter

Styles: **305, 307**

HSS

Staggered Tooth

Style: **305**

Note

For side milling and slotting.

*This item is being
obsoleted. Only
available until
inventory is depleted.*



HSS

Style: **307**

Note

For deep slotting.

*This item is being
obsoleted. Only
available until
inventory is depleted.*



size no.	width of face (in)	cutter diameter (in)	hole size (in)	teeth	order number
305-16	.2500	4.00	1.00	24	C45064
305-17	.3750	4.00	1.00	24	C45065
305-19	.5000	4.00	1.25	22	C45067
305-31	.7500	5.00	1.25	26	C45078

size no.	width of face (in)	cutter diameter (in)	hole size (in)	teeth	order number
307-6	.2500	3.00	1.00	16	C45114
307-24	.5000	6.00	1.25	24	C45132

Woodruff Keyseat Cutter

HSS, 1/2" Shank

Style: **321**

Note

For milling Woodruff keys.
Furnished 1/32" large to allow
for re-sharpening.



*This item is being
obsoleted. Only
available until
inventory is depleted.*

size no. key no.	nominal diameter (in)	width of face (in)	overall length (in)	teeth	order number
202	.2500	.063	2.063	8	C45481
202-1/2	.3125	.063	2.063	8	C45520
203	.3750	.063	2.063	8	C45482
204	.5000	.063	2.063	10	C45483
302-1/2	.3125	.094	2.094	8	C45521
304	.5000	.094	2.094	10	C45485
305	.6250	.094	2.094	10	C45486
403	.3750	.125	2.125	8	C45487
404	.5000	.125	2.125	10	C45488
405	.6250	.125	2.125	10	C45489
406	.7500	.125	2.125	10	C45490
506	.7500	.156	2.156	10	C45492
605	.6250	.188	2.188	10	C45494
606	.7500	.188	2.188	10	C45495
608	1.0000	.188	2.188	12	C45497
610	1.2500	.188	2.188	14	C45499
806	.7500	.250	2.250	10	C45504
807 (121)	.8750	.250	2.250	14	C45505
808 (141)	1.0000	.250	2.250	12	C45506
809	1.1250	.250	2.250	14	C45507
810	1.2500	.250	2.250	14	C45508
811	1.3750	.250	2.250	14	C45509
812	1.5000	.250	2.250	16	C45510
1008 (131)	1.0000	.313	2.313	12	C45511
1009 (161)	1.1500	.313	2.313	14	C45512
1010	1.2500	.313	2.313	14	C45513
1012	1.5000	.313	2.313	16	C45515
1210	1.2500	.375	2.375	12	C45517
1212	1.5000	.375	2.375	16	C45519

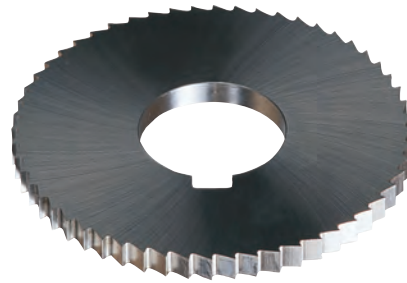
Styles: 318
**HSS Screw
Slotting Saws**
Note
For slotting screw and bolt heads.

*This item is being
obsoleted. Only
available until
inventory is depleted.*

size no.	width of face (in)	cutter diameter (in)	hole size (in)	teeth	wire gage	order number 318
318-79	.0160	1.75	.625	90	26	C45245
318-75	.0250	1.75	.625	90	22	C45241
318-72	.0360	1.75	.625	90	19	C45238
318-67	.0640	1.75	.625	90	14	C45233
318-61	.0360	2.25	.625	60	19	C45227
318-25	.0100	2.75	1.000	72	30	C45215
318-24	.0130	2.75	1.000	72	28	C45214
318-20	.0200	2.75	1.000	72	24	C45210
318-18	.0250	2.75	1.000	72	22	C45208
318-17	.0280	2.75	1.000	72	21	C45207

size no.	width of face (in)	cutter diameter (in)	hole size (in)	teeth	wire gage	order number 318
318-16	.0320	2.75	1.000	72	20	C45206
318-14	.0400	2.75	1.000	72	18	C45204
318-13	.0450	2.75	1.000	72	17	C45203
318-12	.0510	2.75	1.000	72	16	C45202
318-11	.0570	2.75	1.000	72	15	C45201
318-10	.0640	2.75	1.000	72	14	C45200
318-9909	.0720	2.75	1.000	56	13	C45308
318-8	.0810	2.75	1.000	72	12	C45198
318-7	.0910	2.75	1.000	72	11	C45197
318-6	.1020	2.75	1.000	72	10	C45196
318-4	.1280	2.75	1.000	72	8	C45194

Style: 326
**HSS Plain Metal
Slitting Saws**
Note
For slotting and cutoff operations.

*This item is being
obsoleted. Only
available until
inventory is depleted.*

size no.	width of face (in)	cutter diameter (in)	hole size (in)	teeth	order number 326
326-9011	.0312	2.00	.500	38	C45532
326-6	.0312	3.00	1.000	36	C45542
326-7	.0469	3.00	1.000	36	C45543
326-8	.0625	3.00	1.000	36	C45544
326-9	.0938	3.00	1.000	36	C45545
326-10	.1250	3.00	1.000	36	C45546
326-11	.1562	3.00	1.000	36	C45547
326-12	.0312	4.00	1.000	40	C45548
326-13	.0469	4.00	1.000	40	C45549

size no.	width of face (in)	cutter diameter (in)	hole size (in)	teeth	order number 326
326-14	.0625	4.00	1.000	40	C45550
326-15	.0938	4.00	1.000	40	C45551
326-16	.1250	4.00	1.000	40	C45552
326-19	.0625	5.00	1.000	44	C45555
326-20	.0938	5.00	1.000	44	C45556
326-21	.1250	5.00	1.000	44	C45557
326-22	.1250	5.00	1.250	44	C45558
326-25	.0625	6.00	1.000	48	C45559
326-26	.0938	6.00	1.000	48	C45560

Note
For slotting and cutoff operations.



*This item is being
obsoleted. Only
available until
inventory is depleted.*

size no.	width of face (in)	cutter diameter (in)	hole size (in)	teeth	order number 327
327-2	.0938	2.50	.875	28	C45571
327-3	.1250	2.50	.875	28	C45572
327-4	.0625	3.00	1.000	32	C45573
327-5	.0938	3.00	1.000	32	C45574
327-6	.1250	3.00	1.000	32	C45575
327-7	.1562	3.00	1.000	32	C45576
327-8	.0625	4.00	1.000	36	C45577
327-9	.0938	4.00	1.000	36	C45578
327-10	.1250	4.00	1.000	36	C45579
327-15	.1250	5.00	1.000	40	C45584

Set - Drill Case

Metal, No Drills

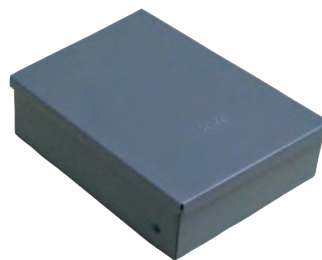
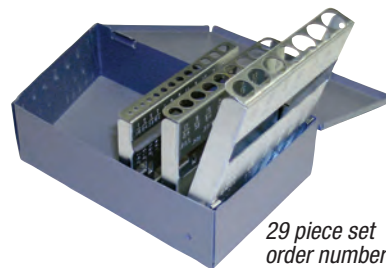

29 piece set
order number
#C00851

case number	slots (no. of pieces)	holds drill size	order number
#4115	115	1/64" to 1/2" x 1/64", A to Z letter, #1 to #60 wire	C00878
#413	13	1/16 to 1/4 x 1/64"	C00854
#415	15	1/16" to 1/2" x 1/32"	C00852
#421	21	1/16" to 3/8" x 1/64"	C00853
#426	26	A to Z letter	C00857
#429	29	1/16" to 1/2" x 1/64"	C00851
#460	60	#1 to #60 wire	C00855
#2001M	25	1.0mm to 13.0 mm x 0.5mm	C00865

Order Number	Style Number	Page Number	Order Number	Style Number	Page Number	Order Number	Style Number	Page Number	Order Number	Style Number	Page Number	Order Number	Style Number	Page Number
C01825	2001	44	C02928	2012	47	C03064	2012	48	C03517	2020	45	C03728	2065-TN	49
C01827	2001	44	C02932	2012	47	C03066	2012	48	C03519	2020	45	C03730	2065-TN	49
C01828	2001	44	C02934	2012	47	C03068	2012	48	C03520	2020	45	C03731	2065-TN	49
C01830	2001	44	C02938	2012	47	C03070	2012	48	C03522	2020	45	C03732	2065-TN	49
C01832	2001	44	C02940	2012	47	C03073	2012	48	C03523	2020	45	C03733	2065-TN	49
C01833	2001	44	C02942	2012	47	C03077	2012	48	C03525	2020	45	C03738	2065-TN	50
C01835	2001	44	C02945	2012	47	C03079	2012	48	C03527	2020	46	C03741	2065-TN	50
C01836	2001	44	C02947	2012	47	C03081	2012	48	C03529	2020	46	C03742	2065-TN	50
C02593	2011	66	C02950	2012	47	C03083	2012	48	C03532	2020	46	C03743	2065-TN	50
C02646	2011	66	C02952	2012	47	C03086	2012	48	C03535	2020	46	C03745	2065-TN	50
C02652	2011	66	C02954	2012	47	C03088	2012	48	C03537	2020	46	C03747	2065-TN	50
C02654	2011	66	C02955	2012	47	C03094	2012	48	C03538	2020	46	C03750	2065-TN	50
C02659	2011	66	C02958	2012	47	C03095	2012	48	C03540	2020	46	C03751	2065-TN	50
C02666	2011	66	C02959	2012	47	C03097	2012	48	C03542	2020	46	C03752	2065-TN	50
C02667	2011	66	C02962	2012	47	C03099	2012	48	C03544	2020	46	C03753	2065-TN	50
C02671	2011	66	C02965	2012	47	C03101	2012	48	C03546	2020	46	C03756	2065-TN	50
C02681	2011	66	C02968	2012	47	C03106	2012	48	C03548	2020	46	C03758	2065-TN	50
C02685	2011	66	C02969	2012	47	C03108	2012	48	C03549	2020	46	C03760	2065-TN	50
C02690	2011	66	C02971	2012	47	C03111	2012	48	C03550	2020	46	C03761	2065-TN	50
C02694	2011	66	C02973	2012	47	C03114	2012	48	C03552	2020	46	C03762	2065-TN	50
C02700	2011	66	C02975	2012	47	C03116	2012	48	C03553	2020	46	C03764	2065-TN	50
C02702	2011	66	C02976	2012	47	C03119	2012	48	C03556	2020	46	C03765	2065-TN	50
C02704	2011	66	C02978	2012	47	C03121	2012	48	C03559	2020	46	C03773	2065-TN	50
C02707	2011	66	C02980	2012	47	C03124	2012	48	C03560	2020	46	C03776	2065-TN	50
C02710	2011	66	C02982	2012	47	C03127	2012	48	C03561	2020	46	C03781	2065-TN	50
C02713	2011	66	C02983	2012	47	C03129	2012	48	C03563	2020	46	C03784	2065-TN	50
C02719	2011	66	C02985	2012	47	C03133	2012	48	C03565	2020	46	C03786	2065-TN	50
C02724	2011	66	C02986	2012	47	C03136	2012	48	C03567	2020	46	C03801	2065-TN	50
C02735	2011	66	C02988	2012	48	C03137	2012	48	C03568	2020	46	C03804	2065-TN	50
C02746	2011	66	C02990	2012	48	C03142	2012	48	C03571	2020	46	C03806	2065-TN	50
C02767	2011	66	C02992	2012	48	C03144	2012	48	C03572	2020	46	C03807	2065-TN	50
C02776	2011	66	C02995	2012	48	C03146	2012	48	C03574	2020	46	C04356	2120	22
C02785	2011	66	C02998	2012	48	C03148	2012	48	C03576	2020	46	C04357	2120	22
C02807	2011	66	C03000	2012	48	C03149	2012	48	C03577	2020	46	C04359	2120	22
C02811	2011	66	C03001	2012	48	C03150	2012	48	C03579	2020	46	C04360	2120	22
C02818	2011	66	C03003	2012	48	C03152	2012	48	C03581	2020	46	C04363	2120	22
C02833	2011	66	C03005	2012	48	C03155	2012	48	C03582	2020	46	C04364	2120	22
C02848	2011	66	C03007	2012	48	C03158	2012	48	C03583	2020	46	C04368	2120	22
C02861	2011	66	C03009	2012	48	C03160	2012	48	C03585	2020	46	C04370	2120	22
C02867	2011	66	C03011	2012	48	C03163	2012	48	C03588	2020	46	C04374	2120	22
C02872	2011	66	C03012	2012	48	C03165	2012	48	C03590	2020	46	C04376	2120	22
C02877	2011	66	C03013	2012	48	C03457	2020	45	C03592	2020	46	C04378	2120	22
C02881	2012	47	C03015	2012	48	C03458	2020	45	C03594	2020	46	C04381	2120	22
C02883	2012	47	C03016	2012	48	C03460	2020	45	C03597	2020	46	C04383	2120	22
C02887	2012	47	C03019	2012	48	C03461	2020	45	C03601	2020	46	C04386	2120	22
C02890	2012	47	C03022	2012	48	C03464	2020	45	C03610	2020	46	C04388	2120	22
C02893	2012	47	C03023	2012	48	C03469	2020	45	C03618	2020	46	C04390	2120	22
C02894	2012	47	C03024	2012	48	C03471	2020	45	C03632	2020	46	C04391	2120	22
C02896	2012	47	C03026	2012	48	C03475	2020	45	C03636	2020	46	C04394	2120	22
C02898	2012	47	C03028	2012	48	C03477	2020	45	C03643	2020	46	C04395	2120	22
C02899	2012	47	C03030	2012	48	C03479	2020	45	C03651	2020	46	C04398	2120	22
C02901	2012	47	C03031	2012	48	C03482	2020	45	C03658	2020	46	C04401	2120	22
C02903	2012	47	C03034	2012	48	C03484	2020	45	C03673	2020	46	C04404	2120	22
C02904	2012	47	C03035	2012	48	C03487	2020	45	C03681	2020	46	C04405	2120	22
C02906	2012	47	C03037	2012	48	C03489	2020	45	C03686	2020	46	C04407	2120	22
C02907	2012	47	C03039	2012	48	C03491	2020	45	C03689	2020	46	C04409	2120	22
C02909	2012	47	C03040	2012	48	C03492	2020	45	C03692	2020	46	C04411	2120	22
C02910	2012	47	C03042	2012	48	C03495	2020	45	C03695	2020	46	C04412	2120	22
C02912	2012	47	C03044	2012	48	C03496	2020	45	C03697	2020	46	C04414	2120	22
C02914	2012	47	C03045	2012	48	C03499	2020	45	C03702	2020	46	C04416	2120	22
C02915	2012	47	C03046	2012	48	C03502	2020	45	C03705	2065-TN	49	C04418	2120	22
C02917	2012	47	C03048	2012	48	C03505	2020	45	C03708	2065-TN	49	C04419	2120	22
C02918	2012	47	C03051	2012	48	C03506	2020	45	C03711	2065-TN	49	C04421	2120	22
C02920	2012	47	C03053	2012	48	C03508	2020	45	C03718	2065-TN	49	C04422	2120	22
C02921	2012	47	C03055	2012	48	C03510	2020	45	C03720	2065-TN	49	C04424	2120	22
C02923	2012	47	C03057	2012	48	C03512	2020	45	C03722	2065-TN	49	C04426	2120	22
C02924	2012	47	C03060	2012	48	C03513	2020	45	C03724	2065-TN	49	C04428	2120	22
C02927	2012	47	C03063	2012	48	C03515	2020	45	C03725	2065-TN	49	C04431	2120	22

Order Number	Style Number	Page Number	Order Number	Style Number	Page Number	Order Number	Style Number	Page Number	Order Number	Style Number	Page Number	Order Number	Style Number	Page Number
C14771	2133-TC	33	C14915	2513	87	C15103	2175-TA	25	C15265	2175-TC	25	C15333	2175-TC	25
C14772	2133-TC	33	C14935	2513	87	C15104	2175-TA	25	C15266	2175-TC	25	C15334	2175-TC	25
C14773	2133-TC	33	C14954	2513	87	C15105	2175-TA	25	C15267	2175-TC	25	C15335	2175-TC	25
C14774	2133-TC	33	C14973	2513	87	C15106	2175-TA	25	C15268	2175-TC	25	C15336	2175-TC	25
C14775	2133-TC	33	C14984	2513	87	C15107	2175-TA	25	C15269	2175-TC	26	C15337	2175-TC	25
C14786	2133-TC	32	C14999	2513	87	C15108	2175-TA	24	C15270	2175-TC	26	C15338	2175-TC	25
C14787	2133-TC	32	C15007	2513	87	C15109	2175-TA	24	C15271	2175-TC	26	C15339	2175-TC	25
C14788	2133-TC	33	C15014	2513	87	C15110	2175-TA	24	C15272	2175-TC	26	C15340	2175-TC	25
C14790	2133	30	C15028	2513	87	C15111	2175-TA	24	C15273	2175-TC	26	C15341	2175-TC	25
C14800	2133	30	C15031	2513	87	C15112	2175-TA	24	C15274	2175-TC	26	C15342	2175-TC	25
C14801	2133	31	C15034	2513	87	C15113	2175-TA	24	C15275	2175-TC	26	C15343	2175-TC	25
C14802	2133	31	C15037	2513	87	C15114	2175-TA	24	C15276	2175-TC	26	C15344	2175-TC	25
C14803	2133	31	C15039	2513	87	C15115	2175-TA	24	C15277	2175-TC	26	C15345	2175-TC	25
C14804	2133	31	C15042	2513	87	C15116	2175-TA	24	C15278	2175-TC	26	C15346	2175-TC	25
C14805	2133	31	C15044	2513	87	C15117	2175-TA	24	C15279	2175-TC	26	C15347	2175-TC	25
C14806	2133	31	C15050	2175-TA	24	C15118	2175-TA	24	C15280	2175-TC	26	C15348	2175-TC	26
C14807	2133	32	C15051	2175-TA	24	C15119	2175-TA	24	C15281	2175-TC	26	C15349	2175-TC	26
C14808	2133	32	C15052	2175-TA	24	C15120	2175-TA	24	C15282	2175-TC	26	C15350	2175-TC	26
C14809	2133	32	C15053	2175-TA	24	C15121	2175-TA	24	C15283	2175-TC	26	C15351	2175-TC	26
C14810	2133	32	C15054	2175-TA	24	C15122	2175-TA	24	C15284	2175-TC	26	C15352	2175-TC	26
C14811	2133	32	C15055	2175-TA	24	C15123	2175-TA	24	C15285	2175-TC	26	C15353	2175-TC	26
C14812	2133	32	C15056	2175-TA	24	C15124	2175-TA	24	C15286	2175-TC	26	C15354	2175-TC	26
C14813	2133	32	C15057	2175-TA	24	C15125	2175-TA	24	C15287	2175-TC	26	C15355	2175-TC	26
C14814	2133	32	C15058	2175-TA	25	C15126	2175-TA	24	C15288	2175-TC	26	C15540	2075	51
C14815	2133	33	C15059	2175-TA	25	C15127	2175-TA	24	C15289	2175-TC	26	C15541	2075	51
C14816	2133	33	C15060	2175-TA	25	C15128	2175-TA	24	C15290	2175-TC	26	C15542	2075	51
C14817	2133	33	C15061	2175-TA	25	C15129	2175-TA	24	C15291	2175-TC	25	C15543	2075	51
C14818	2133	33	C15062	2175-TA	25	C15130	2175-TA	24	C15292	2175-TC	25	C15544	2075	51
C14819	2133	33	C15063	2175-TA	25	C15131	2175-TA	25	C15293	2175-TC	25	C15545	2075	51
C14820	2133	30	C15064	2175-TA	25	C15132	2175-TA	25	C15294	2175-TC	25	C15546	2075	51
C14821	2133	31	C15065	2175-TA	25	C15133	2175-TA	25	C15295	2175-TC	25	C15547	2075	51
C14822	2133	31	C15066	2175-TA	25	C15134	2175-TA	25	C15296	2175-TC	25	C15548	2075	51
C14823	2133	31	C15067	2175-TA	25	C15135	2175-TA	25	C15297	2175-TC	25	C15549	2075	51
C14824	2133	31	C15068	2175-TA	25	C15136	2175-TA	25	C15298	2175-TC	25	C15550	2075	51
C14825	2133	31	C15069	2175-TA	26	C15137	2175-TA	25	C15299	2175-TC	25	C15551	2075	51
C14826	2133	32	C15070	2175-TA	26	C15138	2175-TA	25	C15300	2175-TC	25	C15552	2075	51
C14827	2133	32	C15071	2175-TA	26	C15139	2175-TA	25	C15301	2175-TC	25	C15553	2075	51
C14828	2133	32	C15072	2175-TA	26	C15140	2175-TA	25	C15302	2175-TC	25	C15554	2075	52
C14829	2133	32	C15073	2175-TA	26	C15141	2175-TA	25	C15303	2175-TC	25	C15555	2075	52
C14830	2133	32	C15074	2175-TA	26	C15142	2175-TA	25	C15304	2175-TC	25	C15556	2075	52
C14831	2133	32	C15075	2175-TA	26	C15143	2175-TA	25	C15305	2175-TC	25	C15557	2075	52
C14832	2133	33	C15076	2175-TA	26	C15144	2175-TA	25	C15306	2175-TC	25	C15558	2075	52
C14835	2133	30	C15077	2175-TA	26	C15145	2175-TA	25	C15307	2175-TC	25	C15559	2075	52
C14838	2133	30	C15078	2175-TA	26	C15146	2175-TA	25	C15308	2175-TC	24	C15560	2075	52
C14840	2133	31	C15079	2175-TA	26	C15147	2175-TA	26	C15309	2175-TC	24	C15561	2075	52
C14841	2133	31	C15080	2175-TA	26	C15148	2175-TA	25	C15310	2175-TC	24	C15562	2075	52
C14842	2133	31	C15081	2175-TA	26	C15149	2175-TA	26	C15311	2175-TC	24	C15563	2075	52
C14843	2133	32	C15082	2175-TA	26	C15150	2175-TA	26	C15312	2175-TC	24	C15564	2075	52
C14844	2133	32	C15083	2175-TA	26	C15151	2175-TA	26	C15313	2175-TC	24	C15565	2075	52
C14846	2133-TC	30	C15084	2175-TA	26	C15152	2175-TA	26	C15314	2175-TC	24	C15566	2075	53
C14848	2133-TC	30	C15085	2175-TA	26	C15153	2175-TA	26	C15315	2175-TC	24	C15567	2075	53
C14850	2133-TC	31	C15086	2175-TA	26	C15154	2175-TA	26	C15316	2175-TC	24	C15568	2075	53
C14852	2133-TC	31	C15087	2175-TA	26	C15155	2175-TA	26	C15317	2175-TC	24	C15569	2075	53
C14854	2133-TC	31	C15088	2175-TA	26	C15250	2175-TC	24	C15318	2175-TC	24	C15570	2075	53
C14856	2133-TC	32	C15089	2175-TA	26	C15251	2175-TC	24	C15319	2175-TC	24	C15571	2075	53
C14858	2133-TC	32	C15090	2175-TA	26	C15252	2175-TC	24	C15320	2175-TC	24	C15572	2075	53
C14860	2133-TC	32	C15091	2175-TA	25	C15253	2175-TC	24	C15321	2175-TC	24	C15573	2075	54
C14861	2133-TC	32	C15092	2175-TA	25	C15254	2175-TC	24	C15322	2175-TC	24	C15574	2075	54
C14862	2133-TC	32	C15093	2175-TA	25	C15255	2175-TC	24	C15323	2175-TC	24	C15575	2075	54
C14863	2133-TC	33	C15094	2175-TA	25	C15256	2175-TC	24	C15324	2175-TC	24	C15576	2075	54
C14864	2133-TC	33	C15095	2175-TA	25	C15257	2175-TC	24	C15325	2175-TC	24	C15577	2075	54
C14865	2133-TC	33	C15096	2175-TA	25	C15258	2175-TC	25	C15326	2175-TC	24	C15580	2075	52
C14866	2133-TC	33	C15097	2175-TA	25	C15259	2175-TC	25	C15327	2175-TC	24	C15581	2075	52
C14867	2133-TC	33	C15098	2175-TA	25	C15260	2175-TC	25	C15328	2175-TC	24	C15582	2075	53
C14869	2133	32	C15099	2175-TA	25	C15261	2175-TC	25	C15329	2175-TC	24	C15583	2075	54
C14873	2513	87	C15100	2175-TA	25	C15262	2175-TC	25	C15330	2175-TC	24	C15650	2075	53
C14882	2513	87	C15101	2175-TA	25	C15263	2175-TC	25	C15331	2175-TC	25	C15651	2075	53
C14893	2513	87	C15102	2175-TA	25	C15264	2175-TC	25	C15332	2175-TC	25	C15652	2075	53

Order Number	Style Number	Page Number	Order Number	Style Number	Page Number	Order Number	Style Number	Page Number	Order Number	Style Number	Page Number	Order Number	Style Number	Page Number
C25314	4001	115	C25801	4001	116	C26615	4001	117	C28022	CI-1000-TC	167	C30827	RG6	270
C25322	4001	115	C25804	4001	116	C26680	4001	117	C28024	CI-1000-TC	167	C30828	RG6	270
C25327	4001	115	C25806	4001	116	C26746	4001	117	C28055	CI-1000-TC	167	C30829	RG6	270
C25330	4001	115	C25807	4001	116	C26811	4001	117	C28057	CI-1000-TC	167	C30830	RG6	270
C25339	4001	115	C25809	4001	116	C26876	4001	117	C29192	0650M	195	C30831	RG6	270
C25346	4001	115	C25811	4001	116	C26941	4001	117	C29193	0650M	195	C30832	RG6	270
C25351	4001	115	C25833	4001	116	C27006	4001	117	C29194	0650M	195	C30833	RG6	270
C25357	4001	115	C25844	4001	116	C27072	4001	117	C29195	0650M	195	C30834	RG6	270
C25360	4001	115	C25845	4001	116	C27137	4001	117	C29196	0650M	195	C30835	RG6	270
C25362	4001	115	C25858	4001	116	C27144	4001	117	C29197	0650M	195	C30836	RG6	270
C25365	4001	115	C25873	4001	116	C27152	4001	117	C29198	0650M	195	C30837	RG6	270
C25366	4001	115	C25878	4001	116	C27159	4001	117	C29199	0650M	195	C30838	RG6	270
C25368	4001	115	C25892	4001	116	C27166	4001	117	C29273	4030	118	C30839	RG6	270
C25369	4001	115	C25911	4001	116	C27180	4001	117	C29311	4030	118	C30840	RG6	270
C25374	4001	115	C25912	4001	116	C27195	4001	117	C29350	4030	118	C30865	4030	118
C25380	4001	115	C25942	4001	116	C27636	CI-1000	167	C29386	4030	118	C30931	4030	118
C25385	4001	115	C25944	4001	116	C27637	CI-1000	167	C29421	4030	118	C30976	RG6-TC	270
C25392	4001	115	C25946	4001	116	C27638	CI-1000	167	C29457	4030	118	C30977	RG6-TC	270
C25397	4001	115	C25947	4001	116	C27639	CI-1000	167	C29493	4030	118	C30978	RG6-TC	270
C25402	4001	115	C25949	4001	116	C27640	CI-1000	167	C29565	4030	118	C30979	RG6-TC	270
C25404	4001	115	C25981	4001	116	C27641	CI-1000	167	C29601	4030	118	C30980	RG6-TC	270
C25408	4001	115	C26014	4001	116	C27642	CI-1000	167	C29637	4030	118	C30981	RG6-TC	270
C25417	4001	115	C26015	4001	116	C27644	CI-1000	167	C29709	4030	118	C30982	RG6-TC	270
C25426	4001	115	C26048	4001	116	C27646	CI-1000	167	C29745	4030	118	C30983	RG6-TC	270
C25438	4001	115	C26080	4001	116	C27655	CI-1000	167	C29803	4030	118	C30984	RG6-TC	270
C25443	4001	115	C26083	4001	117	C27656	CI-1000	167	C29853	4030	118	C30985	RG6-TC	270
C25459	4001	115	C26085	4001	117	C27657	CI-1000	167	C29890	4030	118	C30986	RG6-TC	270
C25473	4001	115	C26086	4001	117	C27658	CI-1000	167	C29925	4030	118	C30987	RG6-TC	270
C25474	4001	115	C26150	4001	117	C27660	CI-1000	167	C29960	4030	118	C30988	RG6-TC	270
C25475	4001	115	C26151	4001	117	C27661	CI-1000	167	C29997	4030	118	C30989	RG6-TC	270
C25483	4001	115	C26167	2636	108	C27667	CI-1000	167	C30033	4030	118	C31044	RG6-TA	270
C25492	4001	115	C26168	2636	108	C27668	CI-1000	167	C30067	4030	118	C31053	RG6-TA	270
C25501	4001	115	C26169	2636	108	C27669	CI-1000	167	C30134	4030	118	C31054	RG6-TA	270
C25508	4001	115	C26170	2636	108	C27670	CI-1000	167	C30168	4030	118	C31055	RG6-TA	270
C25510	4001	115	C26171	2636	108	C27671	CI-1000	167	C30201	4030	118	C31056	RG6-TA	270
C25512	4001	115	C26172	2636	108	C27672	CI-1000	167	C30235	4030	118	C31057	RG6-TA	270
C25513	4001	116	C26173	2636	131	C27673	CI-1000	167	C30268	4030	118	C31058	RG6-TA	270
C25516	4001	116	2636 Set	108		C27675	CI-1000	167	C30335	4030	118	C31059	RG6-TA	270
C25530	4001	116	C26174	2636	108	C27689	T-101	173	C30402	4030	118	C31060	RG6-TA	270
C25539	4001	116	C26175	2636	108	C27696	T-101	173	C30469	4030	118	C31061	4030	118
C25550	4001	116	C26176	2636	108	C27697	T-101	173	C30536	4030	118	C31063	RG6-TA	270
C25552	4001	116	C26177	2636	108	C27698	T-101	173	C30603	4030	118	C31064	RG6-TA	270
C25566	4001	116	C26178	2636	108	C27699	T-101	173	C30670	4030	118	C31065	RG8-TA	271
C25567	4001	116	C26179	2636	108	C27700	T-101	173	C30709	RG8	271	C31067	RG8-TA	271
C25577	4001	116	C26180	2636	131	C27702	T-101	173	C30710	RG8	271	C31069	RG8-TA	271
C25585	4001	116	2636 Set	108		C27703	T-101	173	C30720	RG9	273	C31070	RG8-TA	271
C25605	4001	116	C26181	2646	108	C27704	T-101	173	C30721	RG9	273	C31071	RG8-TA	271
C25608	4001	116	C26182	2646	108	C27708	T-101	173	C30722	RG9	273	C31072	RG8-TA	271
C25617	4001	116	C26183	2646	108	C27720	T-101	173	C30723	RG9	273	C31074	RG8-TA	271
C25622	4001	116	C26184	2646	108	C27723	T-101	173	C30724	RG9	273	C31075	RG8-TA	271
C25634	4001	116	C26185	2646	108	C27897	B-101	180	C30725	RG9	273	C31076	RG8-TA	271
C25655	4001	116	C26186	2646	108	C27898	B-101	180	C30732	RG8	271	C31087	RG6-TA	270
C25658	4001	116	C26187	2646	108,131	C27900	B-101	180	C30733	RG6	270	C31098	RG6-TA	270
C25660	4001	116	C26188	2646	108	C27902	B-101	180	C30734	RG6	270	C31106	RG9-TC	273
C25661	4001	116	C26189	2646	108	C27906	B-101	180	C30735	4030	118	C31109	RG8-TA	271
C25663	4001	116	C26190	2646	108	C27910	B-101	180	C30780	RG9	273	C31111	RG8-TA	271
C25668	4001	116	C26191	2646	108	C27921	B-101	180	C30781	RG9	273	C31115	RG9-TC	273
C25669	4001	116	C26192	2646	108	C27922	B-101	180	C30782	RG9	273	C31117	RG9-TC	273
C25685	4001	116	C26193	2646	108	C27923	B-101	180	C30783	RG9	273	C31119	RG9-TC	273
C25698	4001	116	C26194	2646	108,131	C27926	B-101	180	C30785	RG9	273	C31121	RG9-TC	273
C25707	4001	116	C26217	4001	117	C27927	B-101	180	C30786	RG9	273	C31122	RG9-TC	273
C25723	4001	116	C26218	4001	117	C27928	B-101	180	C30787	RG9	273	C31160	RG6	270
C25733	4001	116	C26284	4001	117	C27930	B-101	180	C30788	RG9	273	C31161	RG6	270
C25742	4001	116	C26351	4001	117	C27931	B-101	180	C30789	RG9	273	C31162	RG6	270
C25743	4001	116	C26352	4001	117	C27932	B-101	180	C30790	RG9	273	C31163	RG6	270
C25764	4001	116	C26418	4001	117	C27933	B-101	180	C30791	RG9	273	C31164	RG6	270
C25768	4001	116	C26485	4001	117	C27934	B-101	180	C30800	4030	118	C31165	RG6	270
C25789	4001	116	C26550	4001	117	C27935	B-101	180	C30826	RG6	270	C31166	RG6	270

Order Number	Style Number	Page Number	Order Number	Style Number	Page Number	Order Number	Style Number	Page Number	Order Number	Style Number	Page Number	Order Number	Style Number	Page Number
C31167	RG6	270	C31907	PM-4DE	274	C31981	PM-4	278	C32216	PMRC-C	282	C32496	HGC-2	264
C31168	RG6	270	C31908	PM-4DE	274	C31982	PM-4	278	C32217	PMRC-C	282	C32497	HGC-2	264
C31169	RG6	270	C31909	PM-4DE	274	C31983	PM-4	278	C32218	PMRC-C	282	C32498	HGC-2	264
C31173	RG8	271	C31910	PM-4DE	274	C31984	PM-4	278	C32219	PMRC-C	282	C32499	HGC-2	264
C31174	RG8	271	C31911	PM-4DE	274	C31987	PM-4	277	C32220	PMRC-C	282	C32500	HGC-2	264
C31175	RG8	271	C31912	PM-4DE	274	C31988	PM-4	277	C32221	PMRC-C	282	C32501	HGC-2	264
C31176	RG8	271	C31913	PM-4DE	274	C31989	PM-4	277	C32222	PMRC-C	282	C32502	HGC-2	264
C31177	RG8	271	C31915	PM-4DE	274	C31990	PM-4	277	C32223	PMRC-C	282	C32503	HGC-2	264
C31178	RG8	271	C31916	PM-4DE	274	C31991	PM-4	277	C32224	PMRC-C	282	C32504	HGC-2	264
C31179	RG8	271	C31918	PM-4DE	274	C31992	PM-4	277	C32225	PMRC-C	282	C32505	HGC-2	264
C31180	RG8	271	C31919	PM-4DE	274	C31993	PM-4	277	C32226	PMRC-C	282	C32506	HGC-2	264
C31181	RG8	271	C31921	PM-4DE	274	C31994	PM-4	277	C32227	PMRC-C	282	C32507	HGC-2	264
C31182	RG8	271	C31923	PM-4DE	274	C31995	PM-4	277	C32228	PMRC-C	282	C32508	HGC-2	264
C31183	RG8	271	C31924	PM-4	277	C31996	PM-4	277	C32229	PMRC-C	282	C32509	HGC-2	264
C31184	RG8	271	C31925	PM-4	277	C31997	PM-4	277	C32230	PMRC-C	282	C32510	HGC-2	264
C31190	RG8	271	C31926	PM-4	277	C31999	PM-4	278	C32231	PMRC-C	282	C32511	HGC-2	264
C31191	4030	118	C31927	PM-4	277	C32000	PM-4	278	C32232	PMRC-C	282	C32512	HGC-2	264
C31193	RG8	271	C31928	PM-4	277	C32001	PM-4	278	C32233	PMRC-C	282	C32513	HGC-2	264
C31194	RG8	271	C31929	PM-4	277	C32002	PM-4	278	C32234	PMRC-C	282	C32514	HGC-2	264
C31195	RG8	271	C31930	PM-4	278	C32003	PM-4	278	C32235	PMRC-C	282	C32515	HGC-2	264
C31197	RG8	271	C31931	PM-4	278	C32004	PM-4	278	C32242	PMRC-C	282	C32516	HGC-2	264
C31198	RG8	271	C31932	PM-4	278	C32005	PM-4	278	C32243	PMRC-C	282	C32517	HGC-2	264
C31199	RG8	271	C31933	PM-4	278	C32006	PM-4	278	C32244	PMRC-C	282	C32518	HGC-2	264
C31205	RG8	271	C31934	PM-4	278	C32007	PM-4	278	C32245	PMRC-C	282	C32519	HGC-2	264
C31208	RG8	272	C31935	PM-4	278	C32008	PM-4	278	C32246	PMRC-C	282	C32520	HGC-2	264
C31209	RG8	272	C31936	PM-4	278	C32009	PM-4	278	C32247	PMRC-C	282	C32521	HGC-2	264
C31279	RG6-TC	270	C31937	PM-4	278	C32010	PM-4	278	C32248	PMRC-C	282	C32522	HGC-2	264
C31280	RG6-TC	270	C31938	PM-4	278	C32011	PM-4	278	C32249	PMRC-C	282	C32523	HGC-2	265
C31281	RG6-TC	270	C31939	PM-4	277	C32014	PM-4	277	C32250	PMRC-C	282	C32524	HGC-2	265
C31282	RG6-TC	270	C31940	PM-4	277	C32015	PM-4	278	C32251	PMRC-C	282	C32525	HGC-2	265
C31283	RG6-TC	270	C31941	PM-4	277	C32016	PM-4	277	C32252	PMRC-C	282	C32527	HGC-2	264
C31284	RG6-TC	270	C31942	PM-4	277	C32017	PM-4	277	C32253	PMRC-C	282	C32528	HGC-2	264
C31285	RG6-TC	270	C31943	PM-4	277	C32018	PM-4	277	C32254	PMRC-C	282	C32529	HGC-2	264
C31286	RG6-TC	270	C31944	PM-4	277	C32019	PM-4	277	C32255	PMRC-C	282	C32530	HGC-2	264
C31287	RG6-TC	270	C31945	PM-4	278	C32020	PM-4	278	C32256	PMRC-C	282	C32531	HGC-2	264
C31291	RG8-TC	271	C31946	PM-4	278	C32021	PM-4	278	C32257	PMRC-C	282	C32532	HGC-2	264
C31292	RG8-TC	271	C31947	PM-4	278	C32022	PM-4	278	C32258	PMRC-C	282	C32533	HGC-2	264
C31293	RG8-TC	271	C31948	PM-4	278	C32023	PM-4	278	C32259	PMRC-C	282	C32534	HGC-2	264
C31294	RG8-TC	271	C31949	PM-4	278	C32024	PM-4	278	C32260	PMRC-C	282	C32535	HGC-2	264
C31295	RG8-TC	271	C31950	PM-4	278	C32025	PM-4	278	C32261	PMRC-C	282	C32536	HGC-2	264
C31296	RG8-TC	271	C31951	PM-4	278	C32027	PM-4	278	C32262	PMRC-C	282	C32537	HGC-2	264
C31297	RG8-TC	271	C31952	PM-4	278	C32032	PM-4	277	C32263	PMRC-C	282	C32538	HGC-2	264
C31298	RG8-TC	271	C31953	PM-4	278	C32033	PM-4	277	C32264	PMRC-C	282	C32539	HGC-2	264
C31299	RG8-TC	271	C31955	PM-4	278	C32034	PM-4	277	C32430	HPDM-2	251	C32540	HGC-2	264
C31300	RG8-TC	271	C31956	PM-4	278	C32035	PM-4	277	C32431	HPDM-2	251	C32541	HGC-2	264
C31301	RG8-TC	271	C31957	PM-4	278	C32036	PM-4	278	C32432	HPDM-2	251	C32542	HGC-2	264
C31302	RG8-TC	271	C31958	PM-4	278	C32037	PM-4	278	C32433	HPDM-2	251	C32543	HGC-2	264
C31303	RG8-TC	271	C31959	PM-4	278	C32038	PM-4	278	C32434	HPDM-2	251	C32544	HGC-2	264
C31304	RG8-TC	271	C31960	PM-4	277	C32039	PM-4	278	C32435	HPDM-2	251	C32545	HGC-2	264
C31305	RG8-TC	271	C31961	PM-4	277	C32040	PM-4	278	C32436	HPDM-2	251	C32546	HGC-2	264
C31306	RG8-TC	271	C31962	PM-4	277	C32041	PM-4	278	C32438	HPDM-2	251	C32547	HGC-2	264
C31307	RG8-TC	271	C31963	PM-4	277	C32043	PM-4	278	C32440	HPDM-2	251	C32548	HGC-2	264
C31308	RG8-TC	271	C31964	PM-4	277	C32057	PM-4B	279	C32480	HGC-2	264	C32550	HGC-2	264
C31313	RG8-TC	272	C31965	PM-4	277	C32058	PM-4B	279	C32481	HGC-2	264	C32551	HGC-2	264
C31314	RG8-TC	272	C31966	PM-4	277	C32059	PM-4B	279	C32482	HGC-2	264	C32552	HGC-2	265
C31322	4030	118	C31967	PM-4	277	C32060	PM-4B	279	C32483	HGC-2	264	C32553	HGC-2	265
C31337	4030	118	C31968	PM-4	277	C32061	PM-4B	279	C32484	HGC-2	264	C32554	HGC-2	265
C31351	4030	118	C31969	PM-4	277	C32062	PM-4B	279	C32485	HGC-2	264	C32556	HGC-4C	267
C31365	4030	118	C31970	PM-4	277	C32063	PM-4B	279	C32486	HGC-2	264	C32557	HGC-4C	267
C31380	4030	118	C31972	PM-4	278	C32064	PM-4B	279	C32487	HGC-2	264	C32558	HGC-4C	267
C31879	PM-4DE	274	C31973	PM-4	278	C32065	PM-4B	279	C32488	HGC-2	264	C32559	HGC-4C	267
C31880	PM-4DE	274	C31974	PM-4	278	C32066	HGA-2	250	C32489	HGC-2	264	C32560	HGC-4C	267
C31881	PM-4DE	274	C31975	PM-4	278	C32210	PMRC-C	282	C32490	HGC-2	264	C32561	HGC-4C	267
C31896	PM-4DE	274	C31976	PM-4	278	C32211	PMRC-C	282	C32491	HGC-2	264	C32562	HGC-4C	267
C31903	PM-4DE	274	C31977	PM-4	278	C32212	PMRC-C	282	C32492	HGC-2	264	C32563	HGC-4C	267
C31904	PM-4DE	274	C31978	PM-4	278	C32213	PMRC-C	282	C32493	HGC-2	264	C32564	HGC-4C	267
C31905	PM-4DE	274	C31979	PM-4	278	C32214	PMRC-C	282	C32494	HGC-2	264	C32565	HGC-4C	267
C31906	PM-4DE	274	C31980	PM-4	278	C32215	PMRC-C	282	C32495	HGC-2	264	C32566	HGC-4C	267

Order Number	Style Number	Page Number	Order Number	Style Number	Page Number	Order Number	Style Number	Page Number	Order Number	Style Number	Page Number	Order Number	Style Number	Page Number
C33415	HG-4C	254	C33493	HGA-2	250	C33667	HD-2	236	C33745	HG-2	242	C33813	HG-2	241
C33416	HG-4C	254	C33494	HGA-2	250	C33668	HD-2	236	C33746	HG-2	242	C33814	HG-2	241
C33417	HG-4C	254	C33495	HGA-2	250	C33670	HD-2	236	C33747	HG-2	242	C33815	HG-2	241
C33418	HG-4C	254	C33496	HGA-2	250	C33671	HD-2	236	C33748	HG-2	242	C33816	HG-2	241
C33419	HG-4C	254	C33500	HGA-2	250	C33672	HD-2	236	C33749	HG-2	242	C33817	HG-2	241
C33420	HG-4C	254	C33502	HGA-2	250	C33673	HD-2	236	C33750	HG-2	242	C33818	HG-2	241
C33421	HG-4C	255	C33504	HGA-2	250	C33674	HD-2	236	C33751	HG-2	242	C33819	HG-2	241
C33422	HG-4C	255	C33506	HGA-2	250	C33675	HD-2	237	C33752	HG-2	242	C33820	HG-2	241
C33423	HG-4C	255	C33511	HGA-2	250	C33676	HD-2	237	C33753	HG-2	242	C33821	HG-2	241
C33424	HG-4C	255	C33512	HGA-2	250	C33677	HD-2	237	C33754	HG-2	241	C33822	HG-2	241
C33425	HG-4C	255	C33513	HGA-2	250	C33678	HD-2	237	C33755	HG-2	241	C33823	HG-2	241
C33426	HG-4C	255	C33514	HGA-2	250	C33679	HD-2	237	C33756	HG-2	241	C33824	HG-2	242
C33428	HG-4C	253	C33515	HGA-2	250	C33680	HD-2	237	C33757	HG-2	241	C33825	HG-2	242
C33429	HG-4C	253	C33516	HGA-2	250	C33682	HD-2	237	C33758	HG-2	241	C33826	HG-2	242
C33430	HG-4C	253	C33517	HGA-2	250	C33684	HD-2	237	C33759	HG-2	241	C33827	HG-2	242
C33431	HG-4C	253	C33518	HGA-2	250	C33686	HD-2	237	C33760	HG-2	241	C33828	HG-2	242
C33432	HG-4C	253	C33519	HGA-2	250	C33688	HD-2	237	C33761	HG-2	241	C33829	HG-2	242
C33433	HG-4C	254	C33522	HGA-2	250	C33689	HD-2	236	C33762	HG-2	241	C33830	HG-2	242
C33434	HG-4C	254	C33523	HGA-2	250	C33690	HD-2	236	C33763	HG-2	241	C33831	HG-2	242
C33435	HG-4C	255	C33524	HGA-2	250	C33691	HD-2	236	C33764	HG-2	241	C33832	HG-2	242
C33436	HG-4C	255	C33525	HGA-2	250	C33692	HD-2	236	C33765	HG-2	241	C33833	HG-2	242
C33437	HG-4C	255	C33526	HGA-2	250	C33693	HD-2	236	C33766	HG-2	241	C33834	HG-2	242
C33438	HG-4C	253	C33528	HGA-2	250	C33694	HD-2	236	C33767	HG-2	241	C33835	HG-2	242
C33439	HG-4C	253	C33530	HGA-2	250	C33695	HD-2	236	C33768	HG-2	241	C33836	HG-2	242
C33440	HG-4C	253	C33535	HGA-2	250	C33696	HD-2	236	C33769	HG-2	241	C33837	HG-2	242
C33441	HG-4C	253	C33536	HGA-2	250	C33697	HD-2	236	C33770	HG-2	242	C33838	HG-2	242
C33442	HG-4C	253	C33537	HGA-2	250	C33698	HD-2	236	C33771	HG-2	242	C33839	HG-2	242
C33443	HG-4C	253	C33538	HGA-2	250	C33699	HD-2	236	C33772	HG-2	242	C33840	HG-2	242
C33444	HG-4C	253	C33539	HGA-2	250	C33700	HD-2	236	C33773	HG-2	242	C33841	HG-2	242
C33445	HG-4C	253	C33540	HGA-2	250	C33701	HD-2	236	C33774	HG-2	242	C33842	4005	119
C33446	HG-4C	254	C33541	HGA-2	250	C33702	HD-2	236	C33775	HG-2	242	C33986	4005	119
C33447	HG-4C	254	C33542	HGA-2	250	C33703	HD-2	236	C33776	HG-2	242	C34129	4005	119
C33448	HG-4C	254	C33543	HGA-2	250	C33704	HD-2	236	C33777	HG-2	242	C34266	4005	119
C33449	HG-4C	254	C33626	HD-2	236	C33705	HD-2	236	C33778	HG-2	242	C34400	4005	119
C33450	HG-4C	254	C33627	HD-2	236	C33706	HD-2	236	C33779	HG-2	242	C34467	4005	119
C33451	HG-4C	254	C33629	HD-2	236	C33707	HD-2	236	C33780	HG-2	242	C34534	4005	119
C33452	HG-4C	254	C33630	HD-2	236	C33708	HD-2	236	C33781	HG-2	242	C34601	4005	119
C33453	HG-4C	255	C33631	HD-2	236	C33709	HD-2	236	C33782	HG-2	242	C34668	4005	119
C33454	HG-4C	255	C33632	HD-2	236	C33711	HD-2	236	C33783	HG-2	242	C34735	4005	119
C33455	HG-4C	255	C33633	HD-2	236	C33712	HD-2	236	C33784	HG-2	242	C34802	4005	119
C33456	HG-4C	255	C33634	HD-2	236	C33713	HD-2	236	C33785	HG-2	242	C34867	4005	119
C33457	HG-4C	253	C33635	HD-2	236	C33714	HD-2	236	C33786	HG-2	242	C34932	4005	119
C33458	HG-4C	253	C33637	HD-2	236	C33715	HD-2	236	C33787	HG-2	242	C34997	4005	119
C33459	HG-4C	253	C33638	HD-2	236	C33716	HD-2	237	C33788	HG-2	242	C35063	4005	119
C33460	HG-4C	253	C33639	HD-2	237	C33717	HD-2	237	C33789	HG-2	242	C35128	4005	119
C33461	HG-4C	253	C33640	HD-2	237	C33718	HD-2	237	C33790	HG-2	243	C35193	4005	119
C33462	HG-4C	253	C33641	HD-2	237	C33719	HD-2	237	C33791	HG-2	243	C35258	4005	119
C33463	HG-4C	253	C33643	HD-2	237	C33720	HD-2	237	C33792	HG-2	243	C35323	4005	119
C33464	HG-4C	253	C33646	HD-2	237	C33721	HD-2	237	C33793	HG-2	243	C35389	4005	119
C33465	HG-4C	254	C33648	HD-2	236	C33723	HD-2	237	C33794	HG-2	243	C35454	4005	119
C33466	HG-4C	254	C33649	HD-2	236	C33725	HD-2	237	C33795	HG-2	243	C35461	4005	119
C33467	HG-4C	254	C33650	HD-2	236	C33727	HD-2	237	C33796	HG-2	243	C35469	4005	119
C33468	HG-4C	254	C33651	HD-2	236	C33729	HD-2	237	C33797	HG-2	243	C35476	4005	119
C33469	HG-4C	254	C33652	HD-2	236	C33730	HG-2	241	C33798	HG-2	243	C35483	4005	119
C33470	HG-4C	254	C33653	HD-2	236	C33731	HG-2	241	C33799	HG-2	243	C35490	4005	119
C33471	HG-4C	254	C33654	HD-2	236	C33732	HG-2	241	C33800	HG-2	243	C35497	4005	119
C33472	HG-4C	255	C33655	HD-2	236	C33733	HG-2	241	C33801	HG-2	243	C35505	4005	119
C33473	HG-4C	255	C33656	HD-2	236	C33734	HG-2	241	C33802	HG-2	243	C35512	4005	119
C33474	HG-4C	255	C33657	HD-2	236	C33735	HG-2	241	C33803	HG-2	241	C38900	HG-2	242
C33475	HG-4C	255	C33658	HD-2	236	C33736	HG-2	241	C33804	HG-2	241	C38901	HG-2	242
C33476	HGA-2	250	C33659	HD-2	236	C33737	HG-2	241	C33805	HG-2	241	C38902	HG-2	242
C33478	HGA-2	250	C33660	HD-2	236	C33738	HG-2	241	C33806	HG-2	241	C38903	HG-2	242
C33480	HGA-2	250	C33661	HD-2	236	C33739	HG-2	241	C33807	HG-2	241	C38904	HG-2	242
C33488	HGA-2	250	C33662	HD-2	236	C33740	HG-2	241	C33808	HG-2	241	C38905	HG-2	243
C33489	HGA-2	250	C33663	HD-2	236	C33741	HG-2	241	C33809	HG-2	241	C38906	HG-2	243
C33490	HGA-2	250	C33664	HD-2	236	C33742	HG-2	241	C33810	HG-2	241	C38907	HG-2	243
C33491	HGA-2	250	C33665	HD-2	236	C33743	HG-2	241	C33811	HG-2	241	C38908	HG-2	243
C33492	HGA-2	250	C33666	HD-2	236	C33744	HG-2	241	C33812	HG-2	241	C38909	HG-2	243

Order Number	Style Number	Page Number	Order Number	Style Number	Page Number	Order Number	Style Number	Page Number	Order Number	Style Number	Page Number	Order Number	Style Number	Page Number
C39722	HG-3	252	C39911	HMD-2	230	C40076	PM-539R	280	C40420	PM-538L	285	C40846	HMG-2	233
C39731	HG-3	252	C39912	HMD-2	230	C40077	PM-539R	280	C40425	PM-538L	285	C40847	HMG-2	233
C39732	HG-3	252	C39950	PM-3	276	C40078	PM-539R	280	C40430	PM-538L	285	C40848	HMG-2	233
C39733	HG-3	252	C39951	PM-3	276	C40079	PM-539R	280	C40435	PM-538L	285	C40849	HMG-2	233
C39734	HG-3	252	C39952	PM-3	276	C40080	PM-539R	280	C40440	PM-538L	285	C40850	HMG-2	233
C39735	HG-3	252	C39953	PM-3	276	C40081	PM-539R	280	C40505	HPDM-2	251	C40851	HMG-2	233
C39736	HG-3	252	C39962	PM-3	276	C40082	PM-539R	280	C40506	HPDM-2	251	C40852	HMG-2	233
C39737	HG-3	252	C39963	PM-3	276	C40083	PM-539R	280	C40507	HPDM-2	251	C40853	HMG-2	233
C39738	HG-3	252	C39964	PM-3	276	C40084	PM-539R	280	C40508	HPDM-2	251	C40876	HMG-4	235
C39739	HG-3	252	C39968	PM-4DE	274	C40085	PM-539R	280	C40509	HPDM-2	251	C40877	HMG-4	235
C39740	HG-3	252	C39969	PM-4DE	274	C40086	PM-539R	280	C40510	HPDM-2	251	C40878	HMG-4	235
C39741	HG-3	252	C39970	PM-4DE	274	C40087	PM-539R	280	C40511	HPDM-2	251	C40879	HMG-4	235
C39742	HG-3	252	C39971	PM-4DE	274	C40295	PM-539L	281	C40512	HPDM-2	251	C40880	HMG-4	235
C39743	HG-3	252	C39972	PM-4DE	274	C40296	PM-539L	281	C40514	HPDM-2	251	C40881	HMG-4	235
C39744	HG-3	252	C39973	PM-4DE	274	C40297	PM-539L	281	C40516	HPDM-2	251	C40882	HMG-4	235
C39745	HG-3	252	C39974	PM-4DE	274	C40298	PM-539L	281	C40518	HPDM-2	251	C40884	HMG-4	235
C39753	HG-3	252	C40003	PM-538R	284	C40299	PM-539L	281	C40519	HPDM-2	251	C40903	HMDC-2	260
C39754	HG-3	252	C40004	PM-538R	284	C40300	PM-539L	281	C40520	HPDM-2	251	C40904	HMDC-2	260
C39755	HG-3	252	C40005	PM-538R	284	C40301	PM-539L	281	C40521	HPDM-2	251	C40905	HMDC-2	260
C39756	HG-3	252	C40006	PM-538R	284	C40305	PM-539L	281	C40522	HPDM-2	251	C40906	HMDC-2	260
C39757	HG-3	252	C40007	PM-538R	284	C40306	PM-539L	281	C40523	HPDM-2	251	C40907	HMDC-2	260
C39758	HG-3	252	C40008	PM-538R	284	C40310	PM-539L	281	C40524	HPDM-2	251	C40908	HMDC-2	260
C39759	HG-3	252	C40009	PM-538R	284	C40311	PM-539L	281	C40525	HPDM-2	251	C40909	HMDC-2	260
C39760	HG-3	252	C40010	PM-538R	284	C40315	PM-539L	281	C40527	HPDM-2	251	C40910	HMDC-2	260
C39761	HG-3	252	C40011	PM-538R	284	C40316	PM-539L	281	C40529	HPDM-2	251	C40911	HMDC-2	260
C39762	HG-3	252	C40012	PM-538R	284	C40320	PM-539L	281	C40531	HPDM-2	251	C40912	HMDC-2	260
C39763	HG-3	252	C40013	PM-538R	284	C40321	PM-539L	281	C40792	PM-2	275	C40913	HMDC-2	260
C39764	HG-3	252	C40014	PM-538R	284	C40345	PM-539R	280	C40793	PM-2	275	C40925	HMDC-2	260
C39765	HG-3	252	C40015	PM-538R	284	C40346	PM-539R	280	C40794	PM-2	275	C40926	HMDC-2	260
C39766	HG-3	252	C40016	PM-538R	284	C40347	PM-539R	280	C40795	PM-2	275	C40927	HMDC-2	260
C39767	HG-3	252	C40017	PM-538R	284	C40348	PM-539R	280	C40796	PM-2	275	C40928	HMDC-2	260
C39775	HG-3	252	C40018	PM-538R	284	C40349	PM-539R	280	C40797	PM-2	275	C40929	HMDC-2	260
C39776	HG-3	252	C40019	PM-538R	284	C40350	PM-539R	280	C40798	PM-2	275	C40930	HMDC-2	260
C39777	HG-3	252	C40020	PM-538R	284	C40351	PM-539R	280	C40799	PM-2	275	C40931	HMDC-2	260
C39778	HG-3	252	C40021	PM-538R	284	C40352	PM-539R	280	C40800	PM-2	275	C40932	HMDC-2	260
C39779	HG-3	252	C40022	PM-538R	284	C40353	PM-539R	280	C40801	PM-2	275	C40933	HMDC-2	260
C39780	HG-3	252	C40023	PM-538R	284	C40354	PM-539R	280	C40802	PM-2	275	C40934	HMDC-2	260
C39781	HG-3	252	C40024	PM-538R	284	C40355	PM-539R	280	C40803	PM-2	275	C40935	HMDC-2	260
C39782	HG-3	252	C40025	PM-538R	284	C40356	PM-539R	280	C40804	PM-2	275	C40936	HMDC-2	260
C39783	HG-3	252	C40026	PM-538R	284	C40357	PM-539R	280	C40809	PM-2	275	C40937	HMDC-2	260
C39784	HG-3	252	C40033	PM-538R	284	C40358	PM-539R	280	C40810	PM-2	275	C40938	HMDC-2	260
C39785	HG-3	252	C40035	PM-538R	284	C40359	PM-539R	280	C40811	PM-2	275	C40939	HMDC-2	260
C39786	HG-3	252	C40036	PM-538R	284	C40360	PM-539R	280	C40812	PM-2	275	C40940	HMDC-2	260
C39787	HG-3	252	C40038	PM-538R	284	C40361	PM-539R	280	C40813	PM-2	275	C40941	HMDC-2	260
C39788	HG-3	252	C40039	PM-538R	284	C40362	PM-539R	280	C40814	PM-2	275	C40942	HMDC-2	260
C39789	HG-3	252	C40041	PM-538R	284	C40363	PM-539R	280	C40815	PM-2	275	C40943	HMDC-2	260
C39851	HMD-2	230	C40042	PM-538R	284	C40364	PM-539R	280	C40816	PM-2	275	C40944	HMDC-2	260
C39852	HMD-2	230	C40044	PM-538R	284	C40365	PM-539R	280	C40817	PM-2	275	C40945	HMDC-2	260
C39853	HMD-2	230	C40045	PM-538R	284	C40366	PM-539R	280	C40818	PM-2	275	C40946	HMDC-2	260
C39854	HMD-2	230	C40047	PM-538R	284	C40367	PM-539R	280	C40819	PM-2	275	C40958	HMDC-2	260
C39855	HMD-2	230	C40048	PM-538R	284	C40368	PM-539R	280	C40820	PM-2	275	C40959	HMDC-2	260
C39856	HMD-2	230	C40049	PM-538R	284	C40369	PM-539R	280	C40821	PM-2	275	C40960	HMDC-2	260
C39857	HMD-2	230	C40050	PM-538R	284	C40370	PM-539R	280	C40826	PM-2	275	C40961	HMDC-2	260
C39858	HMD-2	230	C40052	PM-538R	284	C40374	PM-539R	280	C40827	PM-2	275	C40962	HMDC-2	260
C39860	HMD-2	230	C40053	PM-538R	284	C40375	PM-539R	280	C40828	PM-2	275	C40963	HMDC-2	260
C39861	HMD-2	230	C40055	PM-538R	284	C40379	PM-539R	280	C40829	PM-2	275	C40964	HMDC-2	260
C39883	HMD-2	230	C40056	PM-538R	284	C40380	PM-539R	280	C40830	PM-2	275	C40965	HMDC-2	260
C39884	HMD-2	230	C40058	PM-538R	284	C40384	PM-539R	280	C40831	PM-2	275	C40966	HMDC-2	260
C39885	HMD-2	230	C40059	PM-538R	284	C40385	PM-539R	280	C40832	PM-2	275	C40967	HMDC-2	260
C39886	HMD-2	230	C40061	PM-538R	284	C40390	PM-539R	280	C40833	PM-2	275	C40968	HMDC-2	260
C39887	HMD-2	230	C40062	PM-538R	284	C40391	PM-539R	280	C40834	PM-2	275	C40969	HMDC-4	261
C39888	HMD-2	230	C40063	PM-538R	284	C40392	PM-539R	280	C40835	PM-2	275	C40970	HMDC-4	261
C39889	HMD-2	230	C40064	PM-538R	284	C40393	PM-539R	280	C40836	PM-2	275	C40971	HMDC-4	261
C39891	HMD-2	230	C40066	PM-538R	284	C40394	PM-539R	280	C40837	PM-2	275	C40973	HMDC-4	261
C39892	HMD-2	230	C40072	PM-539R	280	C40400	PM-538L	285	C40838	PM-2	275	C40979	HMDC-4	261
C39893	HMD-2	230	C40073	PM-539R	280	C40405	PM-538L	285	C40843	HMG-2	233	C40980	HMDC-4	261
C39909	HMD-2	230	C40074	PM-539R	280	C40410	PM-538L	285	C40844	HMG-2	233	C40981	HMDC-4	261
C39910	HMD-2	230	C40075	PM-539R	280	C40415	PM-538L	285	C40845	HMG-2	233	C40983	HMDC-4	261

Order Number	Style Number	Page Number	Order Number	Style Number	Page Number	Order Number	Style Number	Page Number	Order Number	Style Number	Page Number	Order Number	Style Number	Page Number
C40984	HMDC-4	261	C41132	PMRF-C	283	C41283	HG-4C	255	C41636	HG-2	242	C41942	HGA-2	250
C40985	HMDC-4	261	C41133	PMRF-C	283	C41289	HG-4B	257	C41637	HG-2	242	C41945	HGA-2	250
C40986	HMDC-4	261	C41134	PMRF-C	283	C41293	HG-4B	257	C41641	HG-2	243	C41952	HGA-2	250
C40987	HMDC-4	261	C41135	PMRF-C	283	C41297	HG-4B	257	C41642	HG-2	243	C42051	HD-2	236
C40988	HMDC-4	261	C41136	PMRF-C	283	C41300	HG-4B	257	C41643	HG-2	243	C42052	HD-2	236
C40994	HMDC-4	261	C41137	PMRF-C	283	C41304	HG-4B	257	C41644	HG-2	243	C42054	HD-2	236
C40995	HMDC-4	261	C41138	PMRF-C	283	C41308	HG-4B	257	C41647	HG-2	243	C42055	HD-2	236
C40996	HMDC-4	261	C41139	PMRF-C	283	C41312	HG-4B	257	C41648	HG-2	243	C42056	HD-2	236
C40997	HMDC-4	261	C41140	PMRF-C	283	C41326	HG-4C	253	C41650	HG-2	243	C42058	HD-2	236
C40998	HMDC-4	261	C41145	PMRF-C	283	C41328	HG-4C	253	C41651	HG-2	243	C42060	HD-2	236
C41001	HMD-2	230	C41146	PMRF-C	283	C41331	HG-4C	253	C41652	HG-2	243	C42061	HD-2	236
C41003	HMD-2	230	C41147	PMRF-C	283	C41335	HG-4C	254	C41655	HG-2	243	C42063	HD-2	236
C41005	HMD-2	230	C41148	PMRF-C	283	C41338	HG-4C	254	C41659	HG-2	243	C42065	HD-2	236
C41006	HMD-2	230	C41149	PMRF-C	283	C41341	HG-4C	254	C41660	HG-2	243	C42067	HD-2	236
C41008	HMD-2	230	C41150	PMRF-C	283	C41345	HG-4C	254	C41662	HG-2	243	C42069	HD-2	236
C41010	HMD-2	230	C41151	PMRF-C	283	C41349	HG-4C	254	C41665	HG-2	243	C42070	HD-2	236
C41012	HMD-2	230	C41153	PMRF-C	283	C41353	HG-4C	255	C41671	HG-2K	246	C42072	HD-2	236
C41013	HMD-2	230	C41154	PMRF-C	283	C41358	HG-4B	257	C41673	HG-2K	246	C42074	HD-2	236
C41014	HMD-2	230	C41155	PMRF-C	283	C41361	HG-4B	257	C41676	HG-2K	246	C42076	HD-2	237
C41016	HMD-2	230	C41156	PMRF-C	283	C41364	HG-4B	257	C41678	HG-2K	246	C42078	HD-2	237
C41017	HMD-2	230	C41157	PMRF-C	283	C41371	HG-4B	257	C41681	HG-2K	246	C42080	HD-2	237
C41021	HMD-2B	231	C41158	PMRF-C	283	C41375	HG-4B	257	C41685	HG-2K	246	C42084	HD-2	237
C41023	HMD-2B	231	C41159	PMRF-C	283	C41377	HG-4B	257	C41688	HG-2K	246	C42088	HD-2	237
C41026	HMD-2B	231	C41160	PMRF-C	283	C41381	HG-4C	253	C41691	HG-2K	246	C42096	HD-2	236
C41029	HMD-2B	231	C41161	PMRF-C	283	C41383	HG-4C	253	C41695	HG-2K	246	C42097	HD-2	236
C41032	HMD-2	230	C41162	PMRF-C	283	C41386	HG-4C	253	C41699	HG-2K	246	C42099	HD-2	236
C41034	HMD-2	230	C41163	PMRF-C	283	C41390	HG-4C	254	C41703	HG-2K	246	C42101	HD-2	236
C41036	HMD-2	230	C41168	PMRF-C	283	C41393	HG-4C	254	C41709	HG-2K	246	C42103	HD-2	236
C41037	HMD-2	230	C41169	PMRF-C	283	C41396	HG-4C	254	C41714	HG-2	241	C42109	HG-2B	245
C41039	HMD-2	230	C41170	PMRF-C	283	C41400	HG-4C	254	C41718	HG-2	242	C42111	HG-2B	245
C41041	HMD-2	230	C41171	PMRF-C	283	C41404	HG-4C	254	C41721	HG-2	242	C42114	HG-2B	245
C41043	HMD-2	230	C41172	PMRF-C	283	C41408	HG-4C	255	C41724	HG-2	242	C42116	HG-2B	245
C41044	HMD-2	230	C41173	PMRF-C	283	C41408	HG-4C	255	C41728	HG-2	242	C42119	HG-2B	245
C41045	HMD-2	230	C41174	PMRF-C	283	C41520	HG-4C	253	C41732	HG-2	243	C42122	HG-2B	245
C41047	HMD-2	230	C41176	PMRF-C	283	C41522	HG-4C	253	C41735	HG-2	243	C42124	HG-2B	245
C41048	HMD-2	230	C41177	PMRF-C	283	C41523	HG-4C	253	C41737	HG-2	243	C42126	HG-2B	245
C41053	HMD-2B	231	C41178	PMRF-C	283	C41524	HG-4C	253	C41738	HG-2	243	C42128	HG-2B	245
C41056	HMD-2B	231	C41180	PMRF-C	283	C41525	HG-4C	254	C41741	HG-2	243	C42129	HG-2B	245
C41060	HMD-2B	231	C41181	PMRF-C	283	C41526	HG-4C	254	C41747	HG-2	243	C42132	HG-2B	245
C41061	HMD-2B	231	C41182	PMRF-C	283	C41527	HG-4C	254	C41772	HGN-2	248	C42133	HG-2B	245
C41063	HMD-2B	231	C41183	PMRF-C	283	C41528	HG-4C	254	C41774	HGN-2	248	C42137	HG-2B	245
C41070	HMD-2	230	C41184	PMRF-C	283	C41550	HG-2	241	C41777	HGN-2	248	C42141	HG-2B	245
C41072	HMD-2	230	C41185	PMRF-C	283	C41551	HG-2	241	C41781	HGN-2	248	C42144	HG-2B	245
C41075	HMD-2	230	C41186	PMRF-C	283	C41552	HG-2	241	C41784	HGN-2	248	C42146	HG-2B	245
C41076	HMD-2	230	C41202	HD-4C	240	C41553	HG-2	241	C41787	HGN-2	248	C42152	HG-2B	245
C41085	HMD-4	232	C41204	HD-4C	240	C41554	HG-2	241	C41795	HGN-2	248	C42158	HGN-2B	249
C41087	HMD-4	232	C41207	HD-4C	240	C41555	HG-2	242	C41799	HGN-2	248	C42160	HGN-2B	249
C41090	HMD-4	232	C41209	HD-4C	240	C41556	HG-2	242	C41843	HGA-2	250	C42163	HGN-2B	249
C41091	HMD-4	232	C41212	HD-4C	240	C41557	HG-2	242	C41845	HGA-2	250	C42165	HGN-2B	249
C41093	HMD-4	232	C41216	HD-4C	240	C41558	HG-2	243	C41848	HGA-2	250	C42168	HGN-2B	249
C41099	HMD-4	232	C41219	HD-4C	240	C41602	HG-2	241	C41851	HGA-2	250	C42171	HGN-2B	249
C41101	HMD-4	232	C41223	HD-4C	240	C41604	HG-2	241	C41853	HGA-2	250	C42173	HGN-2B	249
C41104	HMD-4	232	C41227	HD-4C	240	C41607	HG-2	241	C41856	HGA-2	250	C42176	HGN-2B	249
C41105	HMD-4	232	C41231	HD-4C	240	C41609	HG-2	241	C41859	HGA-2	250	C42179	HGN-2B	249
C41107	HMD-4	232	C41243	HG-4C	253	C41612	HG-2	241	C41863	HGA-2	250	C42181	HGN-2B	249
C41113	HMD-4	232	C41245	HG-4C	253	C41615	HG-2	241	C41867	HGA-2	250	C42184	HD-2B	238
C41115	HMD-4	232	C41248	HG-4C	253	C41617	HG-2	242	C41888	HGA-2	250	C42186	HD-2B	238
C41118	HMD-4	232	C41250	HG-4C	253	C41618	HG-2	242	C41890	HGA-2	250	C42189	HD-2B	238
C41119	HMD-4	232	C41253	HG-4C	253	C41618	HG-2	242	C41890	HGA-2	250	C42189	HD-2B	238
C41122	PMRF-C	283	C41253	HG-4C	253	C41620	HG-2	242	C41893	HGA-2	250	C42191	HD-2B	238
C41123	PMRF-C	283	C41254	HG-4C	254	C41622	HG-2	242	C41896	HGA-2	250	C42194	HD-2B	238
C41124	PMRF-C	283	C41257	HG-4C	254	C41623	HG-2	242	C41898	HGA-2	250	C42197	HD-2B	238
C41125	PMRF-C	283	C41260	HG-4C	254	C41625	HG-2	242	C41901	HGA-2	250	C42199	HD-2B	238
C41126	PMRF-C	283	C41262	HG-4C	254	C41626	HG-2	242	C41904	HGA-2	250	C42202	HD-2B	238
C41127	PMRF-C	283	C41264	HG-4C	254	C41628	HG-2	242	C41911	HGA-2	250	C42205	HD-2B	238
C41128	PMRF-C	283	C41268	HG-4C	254	C41629	HG-2	242	C41930	HGA-2	250	C42212	HD-2B	238
C41130	PMRF-C	283	C41272	HG-4C	254	C41630	HG-2	242	C41932	HGA-2	250	C42500	PM-4	277
C41131	PMRF-C	283	C41275	HG-4C	255	C41632	HG-2	242	C41935	HGA-2	250	C42502	PM-4	277
			C41277	HG-4C	255	C41635	HG-2	242	C41939	HGA-2	250	C42504	PM-4	277

Order Number	Style Number	Page Number	Order Number	Style Number	Page Number	Order Number	Style Number	Page Number	Order Number	Style Number	Page Number	Order Number	Style Number	Page Number
C42506	PM-4	277	C42867	HGC-4C	268	C43300	PMRC-C	282	C44632	856	347	C45194	318	351
C42508	PM-4	277	C42868	HGC-4C	268	C43301	PMRC-C	282	C44633	861	347	C45196	318	351
C42510	PM-4	278	C42875	HGC-4C	268	C43302	PMRC-C	282	C44634	851	347	C45197	318	351
C42512	PM-4	278	C42876	HGC-4C	268	C43303	PMRC-C	282	C44635	856	347	C45198	318	351
C42514	PM-4	278	C42880	HGC-4C	268	C43304	PMRC-C	282	C44636	861	347	C45200	318	351
C42516	PM-4	278	C42881	HGC-4C	268	C43305	PMRC-C	282	C44637	851	347	C45201	318	351
C42518	PM-4	278	C42913	HGC-4C	267	C43306	PMRC-C	282	C44638	856	347	C45202	318	351
C42520	PM-4	278	C42917	HGC-4C	268	C44505	850	346	C44640	851	347	C45203	318	351
C42550	PM-4B	279	C42920	HGC-4C	268	C44509	850	346	C44641	856	347	C45204	318	351
C42552	PM-4B	279	C42923	HGC-4C	268	C44513	850	346	C44642	861	347	C45206	318	351
C42554	PM-4B	279	C42924	HGC-4C	268	C44514	850	346	C44644	851	347	C45207	318	351
C42556	PM-4B	279	C42931	HGC-4C	268	C44516	850	346	C44645	856	347	C45208	318	351
C42558	PM-4B	279	C42932	HGC-4C	268	C44518	850	346	C44646	861	347	C45210	318	351
C42560	PM-4B	279	C42936	HGC-4C	268	C44520	850	346	C44647	851	347	C45214	318	351
C42562	PM-4B	279	C42937	HGC-4C	268	C44522	850	346	C44648	856	347	C45215	318	351
C42564	PM-4B	279	C43208	PM-4	277	C44525	850	346	C44649	861	347	C45227	318	351
C42566	PM-4B	279	C43209	PM-4	277	C44527	850	346	C44650	851	347	C45233	318	351
C42602	HGC-2	264	C43210	PM-4	277	C44528	850	346	C44651	856	347	C45238	318	351
C42604	HGC-2	264	C43211	PM-4	277	C44530	850	346	C44652	861	347	C45241	318	351
C42607	HGC-2	264	C43212	PM-4	277	C44536	855	346	C44653	851	347	C45245	318	351
C42609	HGC-2	264	C43213	PM-4	277	C44540	855	346	C44654	856	347	C45308	318	351
C42612	HGC-2	264	C43214	PM-4	278	C44544	855	346	C44655	861	347	C45481	321	350
C42616	HGC-2	264	C43215	PM-4	278	C44545	855	346	C44656	851	347	C45482	321	350
C42619	HGC-2	264	C43216	PM-4	278	C44547	855	346	C44657	856	347	C45483	321	350
C42622	HGC-2	265	C43217	PM-4	278	C44549	855	346	C44658	861	347	C45485	321	350
C42629	HGC-2	265	C43218	PM-4	278	C44551	855	346	C44659	851	347	C45486	321	350
C42633	HGC-2	265	C43219	PM-4	278	C44553	855	346	C44660	856	347	C45487	321	350
C42643	HGC-2B	266	C43220	PM-4	278	C44556	855	346	C44661	861	347	C45488	321	350
C42645	HGC-2B	266	C43221	PM-4	278	C44558	855	346	C44671	3507	346	C45489	321	350
C42648	HGC-2B	266	C43222	PM-4	278	C44559	855	346	C44672	3507	346	C45490	321	350
C42650	HGC-2B	266	C43223	PM-4	278	C44561	855	346	C44673	3507	346	C45492	321	350
C42653	HGC-2B	266	C43224	PM-4	278	C44567	860	346	C44674	3507	346	C45494	321	350
C42657	HGC-2B	266	C43228	PMRC-C	282	C44571	860	346	C44675	3507	346	C45495	321	350
C42660	HGC-2B	266	C43229	PMRC-C	282	C44575	860	346	C44676	3507	346	C45497	321	350
C42663	HGC-2B	266	C43230	PMRC-C	282	C44576	860	346	C44677	3507	346	C45499	321	350
C42670	HGC-2B	266	C43231	PMRC-C	282	C44578	860	346	C44678	3507	346	C45504	321	350
C42684	HGC-4C	267	C43232	PMRC-C	282	C44580	860	346	C44679	3507	346	C45505	321	350
C42686	HGC-4C	267	C43233	PMRC-C	282	C44582	860	346	C44685	3517	347	C45506	321	350
C42689	HGC-4C	267	C43234	PMRC-C	282	C44584	860	346	C44686	3517	347	C45507	321	350
C42691	HGC-4C	267	C43235	PMRC-C	282	C44587	860	346	C44687	3517	347	C45508	321	350
C42694	HGC-4C	267	C43236	PMRC-C	282	C44589	860	346	C44689	3517	347	C45509	321	350
C42698	HGC-4C	268	C43237	PMRC-C	282	C44590	860	346	C44690	3517	347	C45510	321	350
C42699	HGC-4C	268	C43238	PMRC-C	282	C44592	860	346	C44692	3517	347	C45511	321	350
C42702	HGC-4C	268	C43239	PMRC-C	282	C44600	851	347	C44693	3517	347	C45512	321	350
C42703	HGC-4C	268	C43244	PM-538R	284	C44601	856	347	C44694	3517	347	C45513	321	350
C42706	HGC-4C	268	C43246	PM-538R	284	C44602	861	347	C44696	3517	347	C45515	321	350
C42707	HGC-4C	268	C43247	PM-538R	284	C44606	851	347	C44697	3517	347	C45517	321	350
C42714	HGC-4C	268	C43249	PM-538R	284	C44607	856	347	C44701	852	348	C45519	321	350
C42715	HGC-4C	268	C43250	PM-538R	284	C44608	861	347	C44703	852	348	C45520	321	350
C42719	HGC-4C	268	C43252	PM-538R	284	C44609	851	347	C44704	857	348	C45521	321	350
C42720	HGC-4C	268	C43253	PM-538R	284	C44610	856	347	C44705	852	348	C45532	326	351
C42726	HGC-4C	268	C43255	PM-538R	284	C44611	861	347	C44706	857	348	C45542	326	351
C42727	HGC-4C	268	C43280	PM-4	277	C44616	851	347	C44709	852	348	C45543	326	351
C42731	HGC-4C	268	C43281	PM-4	277	C44617	856	347	C44710	857	348	C45544	326	351
C42778	HGC-4B	269	C43282	PM-4	277	C44618	861	347	C44715	852	348	C45545	326	351
C42780	HGC-4B	269	C43283	PM-4	277	C44619	851	347	C44721	852	348	C45546	326	351
C42783	HGC-4B	269	C43284	PM-4	277	C44620	856	347	C44723	852	348	C45547	326	351
C42785	HGC-4B	269	C43285	PM-4	277	C44621	861	347	C44725	852	348	C45548	326	351
C42788	HGC-4B	269	C43286	PM-4	278	C44622	851	347	C44726	857	348	C45549	326	351
C42792	HGC-4B	269	C43290	PM-4	277	C44623	856	347	C44731	852	348	C45550	326	351
C42795	HGC-4B	269	C43291	PM-4	277	C44624	861	347	C44740	853	348	C45551	326	351
C42798	HGC-4B	269	C43292	PM-4	277	C44625	851	347	C44748	853	348	C45552	326	351
C42799	HGC-4B	269	C43293	PM-4	278	C44626	856	347	C45064	305	350	C45555	326	351
C42806	HGC-4B	269	C43294	PM-4	278	C44627	861	347	C45065	305	350	C45556	326	351
C42807	HGC-4B	269	C43295	PM-4	278	C44628	851	347	C45067	305	350	C45557	326	351
C42857	HGC-4C	267	C43296	PM-4	278	C44629	856	347	C45078	305	350	C45558	326	351
C42861	HGC-4C	268	C43297	PM-4	278	C44630	861	347	C45114	307	350	C45559	326	351
C42864	HGC-4C	268	C43299	PMRC-C	282	C44631	851	347	C45132	307	350	C45560	326	351

Order Number	Style Number	Page Number	Order Number	Style Number	Page Number	Order Number	Style Number	Page Number	Order Number	Style Number	Page Number	Order Number	Style Number	Page Number
C47249	1727	74	C49277	PM-3	276	C52191	PM-4DE	274	C54122	1003	162	C54279	1003	162
C47250	1727	75	C49278	PM-3	276	C52192	PM-4DE	274	C54123	1004	162	C54280	1004	162
C47251	1727	75	C49283	PM-3	276	C52193	PM-4DE	274	C54131	1001	165	C54289	1001	162
C47252	1727	75	C49284	PM-3	276	C52194	PM-4DE	274	C54132	1002	165	C54290	1002	162
C47253	1727	75	C49285	PM-3	276	C52195	PM-4DE	274	C54133	1003	165	C54291	1003	162
C47254	1727	75	C50103	1730	113	C52196	PM-4DE	274	C54142	1002	162	C54292	1004	162
C47255	1727	75	C50121	1730	113	C52197	PM-4DE	274	C54147	1002	162	C54303	1001	165
C47256	1727	75	C50133	1730	113	C52198	PM-4DE	274	C54148	1003	162	C54304	1002	165
C47257	1727	75	C50145	1730	113	C52199	PM-4DE	274	C54149	1001	162	C54305	1003	165
C47258	1727	75	C50157	1730	113	C52772	1798	104	C54150	1002	162	C54307	1001-TN	162
C47259	1727	75	C50168	1730	113	C52773	1798	104	C54151	1003	162	C54309	1001-TN	163
C47260	1727	75	C50180	1730	113	C52774	1798	104	C54152	1004	162	C54318	1002	162
C47261	1727	75	C50194	1730	113	C52775	1798	104	C54153	1001	162	C54321	1001	162
C47517	1727	73	C50203	1730	113	C52776	1798	104	C54154	1002	162	C54322	1002	162
C47519	1727	73	C50214	1730	113	C52777	1798	104	C54155	1003	162	C54323	1003	162
C47526	1727	73	C50226	1730	113	C53651	192	345	C54156	1004	162	C54324	1004	162
C47548	1727	73	C50368	4703	120	C53652	192	345	C54164	1001	165	C54325	1002	162
C47552	1727	73	C50382	4703	120	C53653	192	345	C54165	1002	165	C54326	1003	162
C47561	1727	73	C50391	4703	120	C53654	192	345	C54166	1003	165	C54327	1002	162
C47571	1727	74	C50402	4703	120	C53655	192	345	C54167	1004	165	C54328	1003	162
C47574	1727	74	C50414	4703	120	C53656	192	345	C54186	1002	162	C54329	1001	162
C47580	1727	74	C50423	4703	120	C53657	192	345	C54187	1003	162	C54330	1002	162
C47582	1727	74	C50428	4703	120	C53658	192	345	C54188	1001	162	C54331	1003	162
C47591	1727	74	C50433	4703	120	C53659	192	345	C54189	1002	162	C54332	1004	162
C47602	1727	74	C50438	4703	120	C53660	192	345	C54190	1003	162	C54343	1002	162
C47613	1727	74	C50443	4703	120	C53661	192	345	C54191	1004	162	C54348	1001	162
C47618	1727	74	C50449	4703	120	C53662	192	345	C54192	1001	162	C54349	1002	162
C47623	1727	74	C50459	4703	120	C53665	105	112	C54193	1002	162	C54350	1003	162
C47625	1727	74	C52151	HDC-2	262	C53666	105	112	C54194	1003	162	C54351	1004	162
C47634	1727	74	C52152	HDC-2	262	C53667	105	112	C54195	1004	162	C54352	1002	162
C47648	1727	74	C52153	HDC-2	262	C53668	105	112	C54203	1001	165	C54353	1003	162
C47671	1727	75	C52154	HDC-2	262	C53669	192	345	C54204	1002	165	C54354	1002	163
C47694	1727	75	C52155	HDC-2	262	C53670	192	345	C54205	1003	165	C54355	1003	163
C47708	1727	75	C52156	HDC-2	262	C53671	192	345	C54215	1002	162	C54356	1001	163
C47718	1727	75	C52157	HDC-2	262	C54025	1001	162	C54216	1003	162	C54357	1002	163
C48655	2727	70	C52158	HDC-2	262	C54026	1002	162	C54217	1001	162	C54358	1003	163
C48675	2727	70	C52159	HDC-2	262	C54027	1003	162	C54218	1002	162	C54359	1004	163
C48697	2727	70	C52160	HDC-2	262	C54029	1002	162	C54219	1003	162	C54374	1001	165
C48707	2727	70	C52161	HDC-2	262	C54030	1003	162	C54220	1004	162	C54375	1002	165
C48718	2727	70	C52162	HDC-2	262	C54044	1002	165	C54221	1002	162	C54376	1003	165
C48736	2727	70	C52163	HDC-2	262	C54045	1003	165	C54222	1003	162	C54377	1004	165
C48758	2727	70	C52164	HDC-2	262	C54055	1001	162	C54223	1001	162	C54385	1001	163
C48769	2727	70	C52165	HDC-2	262	C54056	1002	162	C54224	1002	162	C54386	1002	163
C48784	2727	70	C52166	HDC-2	262	C54057	1003	162	C54225	1003	162	C54387	1003	163
C48799	2727	70	C52167	HDC-2	262	C54060	1001	162	C54226	1004	162	C54388	1004	163
C48812	2727	70	C52168	HDC-2	262	C54061	1002	162	C54232	1001	162	C54389	1001	163
C48818	2727	70	C52169	HDC-2	262	C54062	1003	162	C54233	1002	162	C54390	1002	163
C48823	2727	70	C52170	HDC-4C	263	C54073	1001	165	C54234	1003	162	C54391	1003	163
C48828	2727	70	C52171	HDC-4C	263	C54074	1002	165	C54235	1004	162	C54392	1004	163
C49017	2745	80	C52172	HDC-4C	263	C54075	1003	165	C54246	1001	165	C54413	1001	165
C49029	2745	80	C52173	HDC-4C	263	C54083	1001	162	C54247	1002	165	C54414	1002	165
C49041	2745	80	C52174	HDC-4C	263	C54084	1002	162	C54248	1003	165	C54415	1003	165
C49052	2745	80	C52175	HDC-4C	263	C54085	1003	162	C54249	1004	165	C54416	1004	165
C49064	2745	80	C52176	HDC-4C	263	C54087	1002	162	C54256	1002	162	C54443	1001	163
C49078	2745	80	C52177	HDC-4C	263	C54088	1003	162	C54264	1002	162	C54444	1002	163
C49087	2745	80	C52178	HDC-4C	263	C54089	1001	162	C54265	1003	162	C54445	1003	163
C49098	2745	80	C52179	HDC-4C	263	C54090	1002	162	C54267	1002	162	C54447	1004	163
C49110	2745	80	C52180	HDC-4C	263	C54091	1003	162	C54268	1003	162	C54448	1001	163
C49119	2745	80	C52181	HDC-4C	263	C54092	1004	162	C54269	1001	162	C54449	1002	163
C49121	2745	80	C52182	HDC-4C	263	C54093	1001	162	C54270	1002	162	C54450	1003	163
C49124	2745	80	C52183	HDC-4C	263	C54094	1002	162	C54271	1003	162	C54451	1002	163
C49129	2745	80	C52184	HDC-4C	263	C54095	1003	162	C54272	1004	162	C54452	1004	163
C49134	2745	80	C52185	HDC-4C	263	C54115	1001	162	C54273	1002	162	C54453	1001	163
C49139	2745	80	C52186	HDC-4C	263	C54116	1002	162	C54274	1003	162	C54454	1002	163
C49145	2745	80	C52187	HDC-4C	263	C54117	1003	162	C54275	1002	162	C54455	1003	163
C49155	2745	80	C52188	HDC-4C	263	C54118	1004	162	C54276	1003	162	C54456	1002	163
C49272	PM-3	276	C52189	PM-4DE	274	C54120	1001	162	C54277	1001	162	C54457	1003	163
C49275	PM-3	276	C52190	PM-4DE	274	C54121	1002	162	C54278	1002	162	C54458	1002	163

Order Number	Style Number	Page Number	Order Number	Style Number	Page Number	Order Number	Style Number	Page Number	Order Number	Style Number	Page Number	Order Number	Style Number	Page Number
C54459	1003	163	C54626	1003	165	C54813	1001	164	C55063	1001	164	C55294	1011TN	168
C54460	1004	163	C54627	1004	165	C54814	1002	164	C55064	1002	164	C55296	1011TN	168
C54461	1002	163	C54652	1001	163	C54815	1003	164	C55065	1003	164	C55298	1011TN	168
C54462	1003	163	C54653	1002	163	C54816	1004	164	C55090	1002	164,202	C55299	1011TN	168
C54463	1002	163	C54654	1003	163	C54817	1001	164	C55100	1002-TN	162	C55300	1011TN	168
C54464	1002	163	C54656	1004	163	C54818	1002	164	C55102	1002-TN	162	C55302	1011TN	168
C54467	1002	163	C54658	1002	163	C54819	1003	164	C55104	1002-TN	162	C55303	1011TN	168
C54468	1003	163	C54659	1003	163	C54820	1004	164	C55106	1002-TN	162	C55304	1011TN	168
C54469	1001	163	C54661	1001	163	C54825	1001	165	C55108	1002-TN	162	C55305	1011TN	168
C54470	1002	163	C54662	1002	163	C54826	1002	165	C55110	1002-TN	163	C55306	1011TN	168
C54471	1003	163	C54663	1003	163	C54833	1001	165	C55112	1002-TN	163	C55307	1011TN	168
C54472	1002	163	C54665	1004	163	C54834	1002	165	C55114	1002-TN	163	C55308	1011TN	168
C54473	1003	163	C54666	1002	163	C54835	1003	165	C55116	1002-TN	163	C55309	1011TN	168
C54474	1002	163	C54667	1003	163	C54838	1001	164	C55118	1002-TN	163	C55310	1011TN	168
C54475	1003	163	C54675	1001	165	C54839	1002	164	C55120	1002-TN	163	C55311	1011TN	168
C54476	1004	163	C54676	1002	165	C54840	1003	164	C55122	1002-TN	163	C55312	1011TN	168
C54489	1001	165	C54677	1003	165	C54841	1004	164	C55124	1002-TN	163	C55313	1011TN	168
C54490	1002	165	C54689	1001	165	C54846	1001	164	C55126	1002-TN	163	C55315	1011TN	168
C54491	1003	165	C54690	1002	165	C54847	1002	164	C55128	1002-TN	163	C55316	1011TN	168
C54502	1002	163	C54691	1003	165	C54848	1003	164	C55130	1002-TN	163	C55317	1011TN	168
C54503	1003	163	C54692	1004	165	C54849	1004	164	C55132	1002-TN	163	C55318	1011TN	169
C54504	1001	163	C54721	0710M	198	C54857	1002	165	C55134	1002-TN	163	C55319	1011TN	169
C54505	1002	163	C54724	1002	163	C54858	1003	165	C55136	1002-TN	164	C55320	1011TN	169
C54506	1003	163	C54726	1001	163	C54864	1001	165	C55138	1002-TN	164	C55321	1011TN	169
C54507	1002	163	C54727	1002	163	C54865	1002	165	C55140	1002-TN	164	C55322	1011TN	169
C54508	1003	163	C54728	1003	163	C54866	1003	165	C55142	1002-TN	164	C55323	1011TN	169
C54509	1002	163	C54729	1002	163	C54867	1004	165	C55144	1002-TN	164	C55324	1011TN	169
C54510	1003	163	C54730	1003	163	C54884	1001	164	C55146	1002-TN	164	C55325	1011TN	169
C54511	1004	163	C54731	1004	163	C54885	1002	164	C55148	1002-TN	164	C55326	1011TN	169
C54512	1002	163	C54732	1002	163	C54886	1003	164	C55150	1002-TN	164	C55328	1011TN	169
C54513	1003	163	C54733	1003	163	C54887	1004	164	C55152	1002-TN	164	C55330	1011TN	169
C54514	1002	163	C54737	1001	163	C54890	1001	164	C55154	1002-TN	164	C55332	1011TN	169
C54518	1001	163	C54738	1002	163	C54891	1002	164	C55156	1002-TN	162	C55333	1011TN	169
C54519	1002	163	C54739	1003	163	C54892	1003	164	C55158	1002-TN	162	C55334	1011TN	169
C54520	1003	163	C54740	1002	163	C54893	1004	164	C55160	1002-TN	162	C55336	1011TN	169
C54521	1002	163	C54741	1004	163	C54907	1001	165	C55162	1002-TN	162	C55338	1011TN	169
C54522	1003	163	C54742	1002	163	C54908	1002	165	C55164	1002-TN	162	C55346	1011TN	168
C54523	1004	163	C54751	1001	165	C54909	1003	165	C55166	1002-TN	162	C55348	1011TN	168
C54524	1002	163	C54752	1002	165	C54923	1001	164	C55170	1002-TN	163	C55354	1011TN	169
C54525	1003	163	C54753	1003	165	C54924	1002	164	C55180	1002-TN	163	C55355	1011TN	169
C54536	1001	165	C54755	1001	165	C54925	1003	164	C55200	1003-TN	162	C55360	1011TN	170
C54537	1002	165	C54756	1002	165	C54926	1004	164	C55202	1003-TN	162	C55361	1011TN	170
C54538	1003	165	C54757	1003	165	C54928	1001	164	C55204	1003-TN	162	C55362	1011TN	170
C54539	1004	165	C54758	1004	165	C54929	1002	164	C55208	1003-TN	162	C55363	1011TN	170
C54546	1001	165	C54759	1001	164	C54930	1003	164	C55210	1003-TN	163	C55364	1011TN	170
C54547	1002	165	C54760	1002	164	C54933	1001	164	C55212	1003-TN	163	C55365	1011TN	170
C54548	1003	165	C54761	1003	164	C54934	1002	164	C55214	1003-TN	163	C55370	1011TC	168
C54580	1002	163	C54762	1004	164	C54935	1003	164	C55216	1003-TN	163	C55372	1011TC	168
C54581	1003	163	C54765	1001	164	C54936	1004	164	C55218	1003-TN	163	C55374	1011TC	168
C54582	1001	163	C54766	1002	164	C54965	1001	164	C55220	1003-TN	163	C55376	1011TC	168
C54583	1002	163	C54767	1003	164	C54966	1002	164	C55222	1003-TN	163	C55378	1011TC	168
C54584	1003	163	C54768	1004	164	C54967	1003	164	C55224	1003-TN	163	C55380	1011TC	168
C54585	1002	163	C54780	1002	164	C54971	1001	164	C55226	1003-TN	163	C55382	1011TC	168
C54586	1003	163	C54781	1003	164	C54972	1002	164	C55228	1003-TN	163	C55383	1011TC	168
C54587	1004	163	C54782	1004	164	C54973	1003	164	C55230	1003-TN	163	C55384	1011TC	168
C54588	1002	163	C54783	1002	164	C54991	1002	165	C55232	1003-TN	163	C55386	1011TC	168
C54589	1003	163	C54784	1003	164	C54994	1001	164	C55234	1003-TN	163	C55387	1011TC	169
C54595	1001	163	C54787	1001	164	C54995	1002	164	C55236	1003-TN	164	C55388	1011TC	169
C54596	1002	163	C54788	1002	164	C54996	1003	164	C55238	1003-TN	164	C55389	1011TC	169
C54597	1003	163	C54789	1003	164	C55000	1001	164	C55240	1003-TN	164	C55390	1011TC	169
C54598	1002	163	C54790	1004	164	C55001	1002	164	C55242	1003-TN	164	C55391	1011TC	169
C54599	1003	163	C54797	1001	165	C55002	1003	164	C55244	1003-TN	164	C55392	1011TC	169
C54600	1004	163	C54798	1002	165	C55028	1002	164	C55246	1003-TN	164	C55394	1011TC	169
C54617	1001	165	C54799	1003	165	C55031	1002	164	C55248	1003-TN	164	C55395	1011TC	169
C54618	1002	165	C54801	1001	165	C55032	1003	164	C55250	1003-TN	164	C55396	1011TC	169
C54619	1003	165	C54802	1002	165	C55057	1001	164	C55252	1003-TN	164	C55398	1011TC	169
C54624	1001	165	C54803	1003	165	C55058	1002	164	C55290	1011TN	168	C55415	1011TC	170
C54625	1002	165	C54804	1004	165	C55059	1003	164	C55292	1011TN	168	C55416	1011TC	170

Order Number	Style Number	Page Number	Order Number	Style Number	Page Number	Order Number	Style Number	Page Number	Order Number	Style Number	Page Number	Order Number	Style Number	Page Number
C55417	1011TC	170	C57048	1011	168	C57191	1011	169	C58437	1096	179	C59110	1011E	172
C55418	1011TC	170	C57049	1012	172	C57192	1011	169	C58438	1095	179	C59117	1011E	172
C55419	1011TC	170	C57051	1011	168	C57193	1011	169	C58439	1096	179	C59118	1011E	172
C55420	1011TC	170	C57055	1011	170	C57195	1011	169	C58440	1095	179	C59121	1011E	172
C55421	1011TC	170	C57062	1011	168	C57196	1011	169	C58441	1096	179	C59122	1011E	172
C55566	1094-TN	178	C57063	1012	172	C57199	1011	170	C58442	1095	179	C59126	1011E	172
C55570	1094-TN	178	C57067	1011	170	C57203	1011	170	C58443	1096	179	C59127	1011E	172
C55571	1093-TN	178	C57069	1011	168	C57214	1011	169	C58444	1095	179	C59159	1092	185
C55572	1094-TN	178	C57070	1011	168	C57215	1011	169	C58445	1096	179	C59177	1092	185
C55573	1093-TN	178	C57072	1011	168	C57216	1011	169	C58447	1096	179	C59193	1091	185
C55575	1093-TN	178	C57073	1012	172	C57220	1011	169	C58448	1095	179	C59194	1092	185
C55576	1094-TN	178	C57074	1011	168	C57226	1011	170	C58449	1096	179	C59209	1091	185
C55577	1093-TN	178	C57076	1011	168	C57228	1011	170	C58450	1095	179	C59210	1092	185
C55680	975TN	186	C57080	1011	170	C57230	1011	169	C58451	1096	179	C59221	1091	185
C55682	975TN	186	C57083	1011	168	C57232	1011	169	C58452	1095	179	C59222	1092	185
C55683	975TN	186	C57085	1011	168	C57234	1011	170	C58453	1096	179	C59223	1091	185
C55684	975TN	186	C57086	1012	172	C57236	1011	170	C58515	1093	178	C59224	1092	185
C55685	975TN	186	C57087	1011	168	C57246	1011	169	C58516	1094	178	C59235	1091	185
C55686	975TN	186	C57089	1011	168	C57247	1011	169	C58532	1093	178	C59236	1092	185
C55687	975TN	186	C57092	1011	170	C57253	1011	170	C58533	1094	178	C59237	1091	185
C56000	1002SO	162	C57094	1011	168	C57324	1053	171	C58538	1093	178	C59238	1092	185
C56002	1002SO	162	C57095	1011	168	C57338	1053	171	C58539	1094	178	C59249	1091	185
C56004	1002SO	162	C57097	1011	168	C57348	1053	171	C58544	1093	178	C59250	1092	185
C56006	1002SO	163	C57098	1012	172	C57361	1053	171	C58545	1094	178	C59251	1091	185
C56008	1002SO	163	C57099	1011	168	C57373	1053	171	C58546	1093	178	C59252	1092	185
C56010	1002SO	163	C57102	1011	168	C57380	1053	171	C58547	1094	178	C59256	1091	185
C56012	1002SO	163	C57104	1011	168	C57388	1053	171	C58562	1093	178	C59257	1092	185
C56014	1002SO	163	C57105	1012	172	C57403	1053	171	C58563	1094	178	C59258	1091	185
C56016	1002SO	163	C57106	1011	168	C57404	1053	171	C58564	1093	178	C59259	1092	185
C56020	1002SO	163	C57110	1011	170	C57406	1053	171	C58565	1094	178	C59282	1091	185
C56028	1002	164	C57112	1011	168	C57411	1053	171	C58570	1093	178	C59283	1092	185
C56050	1002TC	162	C57114	1011	168	C57415	1053	171	C58571	1094	178	C59284	1091	185
C56052	1002TC	162	C57118	1011	170	C57428	1053	171	C58572	1093	178	C59285	1092	185
C56054	1002-TN	162	C57127	1011	168	C57437	1053	171	C58573	1094	178	C59289	1091	185
C56056	1002TC	162	C57128	1011	168	C57452	1053	171	C58581	1093	178	C59290	1092	185
C56058	1002TC	162	C57129	1011	168	C57469	1053	171	C58582	1094	178	C59299	1091	185
C56060	1002TC	163	C57130	1011	168	C57492	1053	171	C58583	1093	178	C59300	1092	185
C56062	1002TC	163	C57131	1012	172	C57507	1053	171	C58584	1094	178	C59301	1091	185
C56064	1002TC	163	C57132	1011	168	C57555	1011	169	C58613	1093	178	C59302	1092	185
C56066	1002TC	163	C57133	1011	168	C57600	1011SO	168	C58614	1094	178	C59317	1091	185
C56070	1002TC	163	C57135	1011	168	C57602	1011SO	168	C58615	1093	178	C59318	1092	185
C56076	1002TC	163	C57137	1011	168	C57604	1011SO	168	C58616	1094	178	C59321	1091	185
C56700	965TN	186	C57138	1011	169	C57606	1011SO	168	C58800	1093	178	C59323	1091	185
C56701	965TN	186	C57139	1011	169	C57608	1011SO	168	C58801	1094	178	C59361	1091	185
C56702	965TN	186	C57140	1012	172	C57609	1011SO	168	C58804	1093	178	C59362	1092	185
C56703	965TN	186	C57146	1011	170	C57610	1011SO	168	C58805	1094	178	C59420	1091	185
C56704	965TN	186	C57149	1011	169	C57611	1011SO	168	C58806	1093	178	C59421	1092	185
C56705	965TN	186	C57150	1011	169	C57616	1011SO	168	C58807	1094	178	C59424	1091	185
C56706	965TN	186	C57151	1011	169	C57618	1011SO	168	C58808	1093	178	C59425	1092	185
C57001	1011SO	168	C57152	1011	169	C57619	1011SO	168	C58809	1094	178	C59428	1091	185
C57002	1011SO	168	C57153	1012	172	C57620	1011SO	168	C58810	1093	178	C59429	1092	185
C57009	1011	168	C57154	1011	169	C57622	1011SO	169	C58811	1094	178	C59432	1091	185
C57011	1011	168	C57155	1011	169	C57624	1011SO	169	C58812	1093	178	C59433	1092	185
C57012	1012	172	C57157	1011	169	C57625	1011SO	169	C58813	1094	178	C59436	1092	185
C57015	1011	170	C57160	1011	169	C57626	1011SO	169	C58815	1094	178	C59437	1092	185
C57019	1011	170	C57162	1012	172	C57628	1011SO	169	C58901	1094-TC	178	C59440	1092	185
C57022	1011	168	C57164	1011	169	C57630	1011SO	169	C58904	1093-TC	178	C59441	1092	185
C57023	1011	168	C57168	1011	170	C57632	1011SO	169	C58905	1094-TC	178	C60001	CEM-V-4R	286
C57024	1011	168	C57171	1011	170	C57636	1011SO	169	C58906	1093-TC	178	C60002	CEM-V-4R	286
C57027	1011	170	C57175	1011	169	C57638	1011SO	169	C58907	1094-TC	178	C60003	CEM-V-4R	286
C57031	1011	168	C57176	1011	169	C57640	1011SO	169	C58908	1093-TC	178	C60004	CEM-V-4R	286
C57032	1012	172	C57177	1011	169	C57642	1011SO	169	C58909	1094-TC	178	C60005	CEM-V-4R	286
C57033	1011	168	C57179	1011	169	C57644	1011SO	169	C58910	1093-TC	178	C60006	CEM-V-4R	286
C57036	1011	170	C57180	1011	169	C58432	1095	179	C58911	1094-TC	178	C60007	CEM-V-4R	286
C57038	1011	168	C57181	1011	169	C58433	1096	179	C58912	1093-TC	178	C60008	CEM-V-4R	286
C57041	1011	168	C57182	1011	169	C58434	1095	179	C58913	1094-TC	178	C60009	CEM-V-4R	286
C57044	1011	170	C57187	1011	170	C58435	1096	179	C59106	1011E	172	C60010	CEM-V-4R	286
C57047	1011	168	C57189	1011	170	C58436	1095	179	C59109	1011E	172	C60011	CEM-V-4R	286

Order Number	Style Number	Page Number	Order Number	Style Number	Page Number	Order Number	Style Number	Page Number	Order Number	Style Number	Page Number	Order Number	Style Number	Page Number
C60558	CEM-V2-5R	290	C60627	CEM-AM3	299	C60941	CEM-SE2B	311	C61034	CEM-SE2	309	C61228	CEM-CH2D	322
C60559	CEM-V2-5R	290	C60628	CEM-AM3	299	C60942	CEM-SE2B	311	C61035	CEM-SE2	309	C61229	CEM-CH2D	322
C60560	CEM-V2-5R	290	C60629	CEM-AM3	299	C60943	CEM-SE2B	311	C61036	CEM-SE2	310	C61230	CEM-CH2D	322
C60561	CEM-V2-5R	290	C60630	CEM-AM3	299	C60944	CEM-SE2B	311	C61037	CEM-SE2	310	C61231	CEM-CH2D	322
C60562	CEM-V2-5R	290	C60631	CEM-AM3	299	C60945	CEM-SE2B	311	C61038	CEM-SE2	310	C61657	CEM-SE3	313
C60563	CEM-V2-5R	290	C60632	CEM-AM3	299	C60946	CEM-SE2B	311	C61039	CEM-SE2	310	C61658	CEM-SE3	313
C60564	CEM-V2-5R	290	C60633	CEM-AM3	299	C60947	CEM-SE2B	311	C61040	CEM-SE2	310	C61659	CEM-SE3	313
C60565	CEM-V2-5R	290	C60634	CEM-AM3	300	C60948	CEM-SE2B	311	C61041	CEM-SE2	310	C61660	CEM-SE3	313
C60566	CEM-V2-5R	290	C60635	CEM-AM3	300	C60949	CEM-SE2B	311	C61042	CEM-SE2	310	C61661	CEM-SE3	313
C60567	CEM-V2-5R	290	C60636	CEM-AM3	300	C60950	CEM-SE2B	311	C61043	CEM-SE2	310	C61662	CEM-SE3	313
C60568	CEM-V2-5R	290	C60637	CEM-AM3	300	C60951	CEM-SE2B	312	C61044	CEM-SE2	310	C61663	CEM-SE3	313
C60569	CEM-V2-5R	290	C60638	CEM-AM3	300	C60952	CEM-SE2B	312	C61045	CEM-SE2	310	C61664	CEM-SE3	313
C60570	CEM-V2-5R	291	C60639	CEM-AM3	300	C60953	CEM-SE2B	312	C61046	CEM-SE2	310	C61665	CEM-SE3	313
C60571	CEM-V2-5R	291	C60640	CEM-AM3	300	C60954	CEM-SE2B	312	C61047	CEM-SE2	310	C61666	CEM-SE3	313
C60572	CEM-V2-5R	291	C60641	CEM-AM3	300	C60955	CEM-SE2B	312	C61048	CEM-SE2	310	C61667	CEM-SE3	313
C60573	CEM-V2-5R	291	C60642	CEM-AM3	300	C60956	CEM-SE2B	312	C61049	CEM-SE2	310	C61668	CEM-SE3	313
C60574	CEM-V2-5R	291	C60643	CEM-AM3	300	C60957	CEM-SE2B	312	C61050	CEM-SE2	310	C61669	CEM-SE3	313
C60575	CEM-V2-5R	291	C60644	CEM-AM3	300	C60958	CEM-SE2B	312	C61051	CEM-SE2	310	C61670	CEM-SE3	313
C60576	CEM-V2-5R	291	C60645	CEM-AM3	300	C60959	CEM-SE2B	312	C61052	CEM-SE2	310	C61671	CEM-SE3	313
C60577	CEM-V2-5R	291	C60646	CEM-AM3	300	C60960	CEM-SE2B	312	C61053	CEM-SE2	310	C61672	CEM-SE3	313
C60578	CEM-V2-5R	291	C60647	CEM-AM3	300	C60961	CEM-SE2B	312	C61054	CEM-SE2	310	C61673	CEM-SE3	313
C60579	CEM-V2-5R	291	C60649	CEM-SEST2	321	C60962	CEM-SE2B	312	C61055	CEM-SE2	310	C61674	CEM-SE3	313
C60580	CEM-V2-5R	291	C60650	CEM-SEST2	321	C60963	CEM-SE2B	312	C61056	CEM-SE2	310	C61675	CEM-SE3	313
C60581	CEM-V2-5R	291	C60651	CEM-SEST2	321	C60964	CEM-SE2B	312	C61057	CEM-SE2	310	C61676	CEM-SE3	313
C60582	CEM-V2-5R	291	C60652	CEM-SEST2	321	C60965	CEM-SE2B	312	C61058	CEM-SE2	310	C61677	CEM-SE3	313
C60583	CEM-V2-5R	291	C60653	CEM-SEST2	321	C60966	CEM-SE2B	312	C61059	CEM-SE2	310	C61678	CEM-SE3	313
C60584	CEM-V2-5R	291	C60654	CEM-SEST2	321	C60967	CEM-SE2B	312	C61060	CEM-SE2	310	C61679	CEM-SE3	313
C60585	CEM-V2-5R	291	C60655	CEM-SEST2	321	C60968	CEM-SE2B	312	C61061	CEM-SE2	310	C61680	CEM-SE3	313
C60586	CEM-V2-5R	291	C60732	1002L	166	C60969	CEM-SE2B	312	C61062	CEM-SE2	310	C61681	CEM-SE3	313
C60587	CEM-V2-5R	291	C60748	1002L	166	C60970	CEM-SE2B	312	C61063	CEM-SE2	310	C61682	CEM-SE3	313
C60588	CEM-V2-5R	291	C60752	1002L	166	C60971	CEM-SE2B	312	C61064	CEM-SE2	310	C61683	CEM-SE3	313
C60589	CEM-V2-5R	291	C60760	1002L	166	C60972	CEM-SE2B	312	C61065	CEM-SE2	310	C61684	CEM-SE3	313
C60590	CEM-V2-5R	291	C60764	1002L	166	C60973	CEM-SE2B	312	C61066	CEM-SE2	310	C61685	CEM-SE3	313
C60591	CEM-V2-5R	291	C60776	1002L	166	C60974	CEM-SE2B	312	C61067	CEM-SE2	310	C61686	CEM-SE3	313
C60592	CEM-V2-5R	291	C60780	1002L	166	C60999	1011	169	C61068	CEM-SE2	310	C61687	CEM-SE3	313
C60593	CEM-V2-5R	291	C60796	1002L	166	C61001	CEM-SE2	309	C61069	CEM-SE2	310	C61688	CEM-SE3	313
C60594	CEM-V2-5R	291	C60808	1002L	166	C61002	CEM-SE2	309	C61070	CEM-SE2	310	C61689	CEM-SE3	313
C60595	CEM-V2-5R	291	C60812	1002L	166	C61003	CEM-SE2	309	C61071	CEM-SE2	310	C61690	CEM-SE3	313
C60596	CEM-V2-5R	291	C60831	1002L	166	C61004	CEM-SE2	309	C61072	CEM-SE2	310	C61691	CEM-SE3	313
C60597	CEM-V2-5R	291	C60835	1002L	166	C61005	CEM-SE2	309	C61073	CEM-SE2	310	C61692	CEM-SE3	313
C60598	CEM-V2-5R	291	C60866	1002L	166	C61006	CEM-SE2	309	C61074	CEM-SE2	310	C61693	CEM-SE3	313
C60599	CEM-V2-5R	291	C60914	CEM-SE2B	311	C61007	CEM-SE2	309	C61075	CEM-SE2	310	C61694	CEM-SE3	313
C60600	CEM-V2-5R	291	C60915	CEM-SE2B	311	C61008	CEM-SE2	309	C61076	CEM-SE2	310	C61695	CEM-SE3	313
C60601	CEM-V2-5R	291	C60916	CEM-SE2B	311	C61009	CEM-SE2	309	C61077	CEM-SE2	310	C61696	CEM-SE3	313
C60602	CEM-V2-5R	291	C60917	CEM-SE2B	311	C61010	CEM-SE2	309	C61078	CEM-SE2	310	C61697	CEM-SE3	313
C60603	CEM-V2-5R	291	C60918	CEM-SE2B	311	C61011	CEM-SE2	309	C61079	CEM-SE2	310	C61698	CEM-SE3	313
C60604	CEM-V2-5R	291	C60919	CEM-SE2B	311	C61012	CEM-SE2	309	C61080	CEM-SE2	310	C61699	CEM-SE3	313
C60605	CEM-V2-5R	291	C60920	CEM-SE2B	311	C61013	CEM-SE2	309	C61081	CEM-SE2	310	C61700	CEM-SE3	313
C60606	CEM-V2-5R	291	C60921	CEM-SE2B	311	C61014	CEM-SE2	309	C61082	CEM-SE2	310	C61701	CEM-SE3	313
C60607	CEM-V2-5R	291	C60922	CEM-SE2B	311	C61015	CEM-SE2	309	C61083	CEM-SE2	310	C61805	CEM-SE4	316
C60608	CEM-V2-5R	291	C60923	CEM-SE2B	311	C61016	CEM-SE2	309	C61112	CEM-CH2	322	C61806	CEM-SE4	316
C60609	CEM-V2-5R	291	C60924	CEM-SE2B	311	C61017	CEM-SE2	309	C61113	CEM-CH2	322	C61807	CEM-SE4	316
C60610	CEM-V2-5R	291	C60925	CEM-SE2B	311	C61018	CEM-SE2	309	C61114	CEM-CH2	322	C61808	CEM-SE4	316
C60611	CEM-V2-5R	291	C60926	CEM-SE2B	311	C61019	CEM-SE2	309	C61115	CEM-CH2	322	C61809	CEM-SE4	316
C60612	CEM-V2-5R	291	C60927	CEM-SE2B	311	C61020	CEM-SE2	309	C61116	CEM-CH2	322	C61810	CEM-SE4	316
C60613	CEM-V2-5R	291	C60928	CEM-SE2B	311	C61021	CEM-SE2	309	C61117	CEM-CH2	322	C61811	CEM-SE4	316
C60614	CEM-V2-5R	291	C60929	CEM-SE2B	311	C61022	CEM-SE2	309	C61118	CEM-CH2	322	C61812	CEM-SE4	316
C60616	CEM-AM3	299	C60930	CEM-SE2B	311	C61023	CEM-SE2	309	C61119	CEM-CH2	322	C61813	CEM-SE4	316
C60617	CEM-AM3	299	C60931	CEM-SE2B	311	C61024	CEM-SE2	309	C61120	CEM-CH2	322	C61814	CEM-SE4	316
C60618	CEM-AM3	299	C60932	CEM-SE2B	311	C61025	CEM-SE2	309	C61121	CEM-CH2	322	C61815	CEM-SE4	316
C60619	CEM-AM3	299	C60933	CEM-SE2B	311	C61026	CEM-SE2	309	C61122	CEM-CH2	322	C61816	CEM-SE4	316
C60620	CEM-AM3	299	C60934	CEM-SE2B	311	C61027	CEM-SE2	309	C61123	CEM-CH2	322	C61817	CEM-SE4	316
C60621	CEM-AM3	299	C60935	CEM-SE2B	311	C61028	CEM-SE2	309	C61124	CEM-CH2	322	C61818	CEM-SE4	316
C60622	CEM-AM3	299	C60936	CEM-SE2B	311	C61029	CEM-SE2	309	C61125	CEM-CH2	322	C61819	CEM-SE4	316
C60623	CEM-AM3	299	C60937	CEM-SE2B	311	C61030	CEM-SE2	309	C61126	CEM-CH2	322	C61820	CEM-SE4	316
C60624	CEM-AM3	299	C60938	CEM-SE2B	311	C61031	CEM-SE2	309	C61127	CEM-CH2	322	C61821	CEM-SE4	316
C60625	CEM-AM3	299	C60939	CEM-SE2B	311	C61032	CEM-SE2	309	C61226	CEM-CH2D	322	C61822	CEM-SE4	316
C60626	CEM-AM3	299	C60940	CEM-SE2B	311	C61033	CEM-SE2	309	C61227	CEM-CH2D	322	C61824	CEM-SE4	316

Order Number	Style Number	Page Number	Order Number	Style Number	Page Number	Order Number	Style Number	Page Number	Order Number	Style Number	Page Number	Order Number	Style Number	Page Number
C61825	CEM-SE4	316	C61894	CEM-SE4	318	C63542	CEM-SE4B	320	C64112	966B	187	C65304	0610	197
C61827	CEM-SE4	316	C61895	CEM-SE4	318	C63543	CEM-SE4B	320	C64116	963B	188	C65311	0610	197
C61828	CEM-SE4	316	C61896	CEM-SE4	318	C63544	CEM-SE4B	320	C64117	963B	188	C65312	0610	197
C61829	CEM-SE4	316	C61897	CEM-SE4	318	C63545	CEM-SE4B	320	C64118	963B	188	C65315	0610	197
C61830	CEM-SE4	316	C61898	CEM-SE4	318	C63546	CEM-SE4B	320	C64119	963B	188	C65316	0610	197
C61831	CEM-SE4	316	C61899	CEM-SE4	318	C63547	CEM-SE4B	320	C64129	967B	188	C65328	0610	197
C61832	CEM-SE4	316	C61900	CEM-SE4	318	C63548	CEM-SE4B	320	C64130	967B	188	C65329	0610	197
C61833	CEM-SE4	316	C61901	CEM-SE4	318	C63549	CEM-SE4B	320	C64131	967B	188	C65339	0610	197
C61834	CEM-SE4	316	C61902	CEM-SE4	318	C63550	CEM-SE4B	320	C64132	967B	188	C65340	0610	197
C61835	CEM-SE4	316	C61903	CEM-SE4	318	C63551	CEM-SE4B	320	C64133	967B	188	C65349	0610	197
C61836	CEM-SE4	316	C61904	CEM-SE4	318	C63552	CEM-SE4B	320	C65022	0610	196	C65350	0610	197
C61837	CEM-SE4	316	C61905	CEM-SE4	318	C63553	CEM-SE4B	320	C65026	0610	196	C65374	0610	197
C61838	CEM-SE4	316	C61906	CEM-SE4	318	C63554	CEM-SE4B	320	C65027	0610	196	C65384	0610	197
C61839	CEM-SE4	316	C61907	CEM-SE4	318	C63555	CEM-SE4B	320	C65036	0610	196	C65385	0610	197
C61840	CEM-SE4	316	C61908	CEM-SE4	318	C63556	CEM-SE4B	320	C65037	0610	196	C65395	0610	197
C61841	CEM-SE4	316	C61909	CEM-SE4	318	C63557	CEM-SE4B	320	C65045	0610	196	C65396	0610	197
C61842	CEM-SE4	316	C61910	CEM-SE4	318	C63558	CEM-SE4B	320	C65046	0610	196	C65405	0610	197
C61843	CEM-SE4	316	C61911	CEM-SE4	318	C63559	CEM-SE4B	320	C65048	0610	196	C65406	0610	197
C61844	CEM-SE4	317	C61912	CEM-SE4	318	C63560	CEM-SE4B	320	C65049	0610	196	C65407	0610	197
C61845	CEM-SE4	317	C61913	CEM-SE4	318	C63561	CEM-SE4B	320	C65057	0610	196	C65416	0610	197
C61846	CEM-SE4	317	C61914	CEM-SE4	318	C63562	CEM-SE4B	320	C65058	0610	196	C65417	0610	197
C61847	CEM-SE4	317	C61915	CEM-SE4	318	C63563	CEM-SE4B	320	C65061	0610	196	C65426	0610	197
C61848	CEM-SE4	317	C61916	CEM-SE4	318	C63564	CEM-SE4B	320	C65062	0610	196	C65427	0610	197
C61849	CEM-SE4	317	C61917	CEM-SE4	318	C63565	CEM-SE4B	320	C65069	0610	196	C65433	0610	197
C61850	CEM-SE4	317	C61918	CEM-SE4	318	C63566	CEM-SE4B	320	C65070	0610	196	C65434	0610	197
C61851	CEM-SE4	317	C61919	CEM-SE4	318	C63567	CEM-SE4B	320	C65075	0610	196	C65441	0610	197
C61852	CEM-SE4	317	C61920	CEM-SE4	318	C63568	CEM-SE4B	320	C65076	0610	196	C65442	0610	197
C61853	CEM-SE4	317	C61921	CEM-SE4	318	C63569	CEM-SE4B	320	C65083	0610	196	C65449	0610	197
C61854	CEM-SE4	317	C61922	CEM-SE4	318	C63570	CEM-SE4B	320	C65084	0610	196	C65450	0610	197
C61855	CEM-SE4	317	C61923	CEM-SE4	318	C63571	CEM-SE4B	320	C65093	0610	196	C65470	0610	197
C61856	CEM-SE4	317	C61924	CEM-SE4	318	C63572	CEM-SE4B	320	C65114	0610	196	C65471	0610	197
C61857	CEM-SE4	317	C61925	CEM-SE4	318	C63573	CEM-SE4B	320	C65119	0610	196	C65491	0620	197
C61858	CEM-SE4	317	C61926	CEM-SE4	318	C63574	CEM-SE4B	320	C65124	0610	196	C65492	0620	197
C61859	CEM-SE4	317	C61927	CEM-SE4	318	C63575	CEM-SE4B	320	C65125	0610	196	C65493	0620	197
C61860	CEM-SE4	317	C61928	CEM-SE4	318	C63576	CEM-SE4B	320	C65132	0610	196	C65494	0620	197
C61861	CEM-SE4	317	C63509	CEM-SE4B	319	C63577	CEM-SE4B	320	C65140	0610	196	C65495	0620	197
C61862	CEM-SE4	317	C63510	CEM-SE4B	319	C63578	CEM-SE4B	320	C65142	0610	196	C65497	0620	197
C61863	CEM-SE4	317	C63511	CEM-SE4B	319	C63579	CEM-SE4B	320	C65147	0610	196	C65571	0660	195
C61864	CEM-SE4	317	C63512	CEM-SE4B	319	C64036	965B	186	C65148	0610	196	C65572	0660	195
C61865	CEM-SE4	317	C63513	CEM-SE4B	319	C64037	965B	186	C65159	0610	196	C65573	0660	195
C61866	CEM-SE4	317	C63514	CEM-SE4B	319	C64038	965B	186	C65160	0610	196	C65574	0660	195
C61867	CEM-SE4	317	C63515	CEM-SE4B	319	C64039	965B	186	C65171	0610	196	C65575	0660	195
C61868	CEM-SE4	317	C63516	CEM-SE4B	319	C64040	965B	186	C65172	0610	196	C65576	0660	195
C61869	CEM-SE4	317	C63517	CEM-SE4B	319	C64041	965B	186	C65192	0610	196	C65580	0650M	195
C61870	CEM-SE4	317	C63518	CEM-SE4B	319	C64042	965B	186	C65193	0610	196	C65581	0650M	195
C61871	CEM-SE4	317	C63519	CEM-SE4B	319	C64043	965B	186	C65197	0610	196	C65582	0650M	195
C61872	CEM-SE4	317	C63520	CEM-SE4B	319	C64044	965B	186	C65198	0610	196	C65583	0650M	195
C61873	CEM-SE4	317	C63521	CEM-SE4B	319	C64045	965B	186	C65208	0610	196	C65584	0650M	195
C61874	CEM-SE4	317	C63522	CEM-SE4B	319	C64046	965B	186	C65209	0610	196	C65585	0650M	195
C61875	CEM-SE4	317	C63523	CEM-SE4B	319	C64058	975	186	C65220	0610	196	C65586	0650M	195
C61876	CEM-SE4	317	C63524	CEM-SE4B	319	C64059	975	186	C65221	0610	196	C65587	0650M	195
C61877	CEM-SE4	317	C63525	CEM-SE4B	319	C64060	975	186	C65232	0610	197	C65601	0650	194
C61878	CEM-SE4	317	C63526	CEM-SE4B	319	C64061	975	186	C65233	0610	197	C65602	0650	194
C61879	CEM-SE4	317	C63527	CEM-SE4B	319	C64062	975	186	C65239	0610	197	C65603	0650	194
C61880	CEM-SE4	317	C63528	CEM-SE4B	319	C64063	975	186	C65240	0610	197	C65605	0650	194
C61881	CEM-SE4	317	C63529	CEM-SE4B	319	C64064	975	186	C65243	0610	197	C65606	0650	194
C61882	CEM-SE4	317	C63530	CEM-SE4B	319	C64065	975	186	C65244	0610	197	C65607	0650	194
C61883	CEM-SE4	317	C63531	CEM-SE4B	319	C64098	964B	187	C65250	0610	197	C65608	0650	194
C61884	CEM-SE4	317	C63532	CEM-SE4B	319	C64099	964B	187	C65251	0610	197	C65609	0650	194
C61885	CEM-SE4	317	C63533	CEM-SE4B	319	C64100	964B	187	C65264	0610	196	C65610	0650	194
C61886	CEM-SE4	318	C63534	CEM-SE4B	319	C64101	964B	187	C65265	0610	196	C65611	0650	194
C61887	CEM-SE4	318	C63535	CEM-SE4B	319	C64102	964B	187	C65269	0610	196	C65612	0650	194
C61888	CEM-SE4	318	C63536	CEM-SE4B	319	C64103	964B	187	C65270	0610	196	C65613	0650	194
C61889	CEM-SE4	318	C63537	CEM-SE4B	319	C64107	966B	187	C65280	0610	196	C65614	0650	194
C61890	CEM-SE4	318	C63538	CEM-SE4B	319	C64108	966B	187	C65281	0610	196	C65615	0650	194
C61891	CEM-SE4	318	C63539	CEM-SE4B	319	C64109	966B	187	C65292	0610	196	C65616	0650	194
C61892	CEM-SE4	318	C63540	CEM-SE4B	319	C64110	966B	187	C65293	0610	196	C65617	0650	194
C61893	CEM-SE4	318	C63541	CEM-SE4B	320	C64111	966B	187	C65303	0610	197	C65618	0650	194

Order Number	Style Number	Page Number	Order Number	Style Number	Page Number	Order Number	Style Number	Page Number	Order Number	Style Number	Page Number	Order Number	Style Number	Page Number
C65619	. 0650	. 194	C65901	. 0710M	. 198	C66732	. 0551	. 199	C66826	. 0551	. 200	C70025	. 2213	. 65
C65620	. 0650	. 194	C65946	. 0710	. 197	0552	. 200		C66827	. 0551	. 200	C70026	. 2213	. 65
C65621	. 0650	. 194	C65947	. 0710	. 197	C66733	. 0551	. 199	C66828	. 0551	. 200	C70027	. 2213	. 65
C65622	. 0650	. 194	C65957	. 0710	. 197	0552	. 200		C66829	. 0551	. 200	C70028	. 2213	. 65
C65623	. 0650	. 194	C65958	. 0710	. 197	C66737	. 0552	. 199	C67197	. 240	. 201	C70029	. 2213	. 65
C65624	. 0650	. 194	C65966	. 0710	. 197	C66738	. 0552	. 199	C67200	. 240	. 201	C70030	. 2213	. 65
C65625	. 0650	. 194	C65967	. 0710	. 197	C66739	. 0552	. 199	C67201	. 240	. 201	C70031	. 2213	. 65
C65627	. 0650	. 194	C66218	. CEM-CH4	. 323	C66740	. 0552	. 199	C67202	. 240	. 201	C70032	. 2213	. 64
C65628	. 0650	. 194	C66219	. CEM-CH4	. 323	C66741	. 0552	. 199	C67203	. 240	. 201	C70033	. 2213	. 64
C65629	. 0650	. 194	C66220	. CEM-CH4	. 323	C66746	. 0552	. 199	C67204	. 240	. 201	C70034	. 2213	. 64
C65630	. 0650	. 194	C66221	. CEM-CH4	. 323	C66747	. 0552	. 199	C67205	. 240	. 201	C70035	. 2213	. 64
C65631	. 0650	. 194	C66222	. CEM-CH4	. 323	C66748	. 0552	. 199	C67206	. 242	. 201	C70036	. 2213	. 64
C65632	. 0650	. 194	C66223	. CEM-CH4	. 323	C66749	. 0552	. 199	C67207	. 242	. 201	C70037	. 2213	. 64
C65633	. 0650	. 194	C66224	. CEM-CH4	. 323	C66750	. 0552	. 199	C67208	. 243	. 201	C70038	. 2213	. 64
C65724	. 0710M	. 198	C66225	. CEM-CH4	. 323	C66751	. 0552	. 199	C67209	. 243	. 201	C70039	. 2213	. 64
C65729	. 0710	. 196	C66226	. CEM-CH4	. 323	C66754	. 0553	. 199	C67210	. 244	. 201	C70040	. 2213	. 64
C65730	. 0710	. 196	C66227	. CEM-CH4	. 323	C66755	. 0553	. 199	C67211	. 244	. 201	C70041	. 2213	. 64
C65732	. 0710M	. 198	C66228	. CEM-CH4	. 323	C66756	. 0553	. 199	C67212	. 245	. 201	C70042	. 2213	. 64
C65733	. 0710	. 196	C66229	. CEM-CH4	. 323	C66757	. 0553	. 199	C67213	. 245	. 201	C70043	. 2213	. 64
C65734	. 0710	. 196	C66670	. 0550	. 200	C66758	. 0553	. 199	C67214	. 223	. 200	C70044	. 2213	. 64
C65737	. 0710M	. 198	C66671	. 0550	. 200	C66759	. 0553	. 199	C67215	. 223	. 200	C70045	. 2213	. 64
C65739	. 0710	. 196	C66672	. 0550	. 200	C66760	. 0553	. 199	C67216	. 223	. 200	C70046	. 2213	. 64
C65740	. 0710	. 196	C66673	. 0550	. 200	C66761	. 0553	. 199	C67217	. 223	. 200	C70047	. 2213	. 64
C65742	. 0710M	. 198	C66674	. 0550	. 200	C66762	. 0553	. 199	C67220	. 225	. 200	C70048	. 2213	. 64
C65743	. 0710	. 196	C66675	. 0550	. 200	C66763	. 0553	. 199	C67221	. 225	. 200	C70049	. 2213	. 64
C65744	. 0710	. 196	C66676	. 0550	. 200	C66764	. 0553	. 199	C67223	. 222	. 198	C70050	. 2213	. 64
C65747	. 0710M	. 198	C66677	. 0550	. 200	C66769	. 0553	. 99,200	C67224	. 222	. 198	C70051	. 2213	. 64
C65751	. 0710	. 196	C66678	. 0550	. 200	C66770	. 0553	. 99,200	C67226	. 222	. 198	C70052	. 2213	. 65
C65752	. 0710	. 196	C66679	. 0550	. 200	C66771	. 0553	. 99,200	C67227	. 222	. 198	C70053	. 2213	. 65
C65757	. 0710M	. 198	C66681	. 0552	. 199	C66772	. 0553	. 99,200	C67228	. 222	. 198	C70054	. 2213	. 65
C65760	. 0710	. 196	C66682	. 0552	. 199	C66773	. 0553	. 99,200	C67229	. 222	. 198	C70055	. 2213	. 65
C65761	. 0710	. 196	C66683	. 0552	. 199	C66774	. 0553	. 99,200	C67232	. 226	. 200	C70056	. 2213	. 65
C65766	. 0710	. 196	C66684	. 0552	. 199	C66782	. 0554	. 199	C67235	. 224	. 198	C70057	. 2213	. 61
C65767	. 0710	. 196	C66685	. 0552	. 199	C66783	. 0554	. 199	C67236	. 224	. 198	C70058	. 2213	. 61
C65785	. 0710	. 196	C66686	. 0552	. 199	C66784	. 0554	. 199	C67237	. 224	. 198	C70059	. 2213	. 62
C65789	. 0710	. 196	C66693	. 0550	. 199	C66785	. 0554	. 199	C67238	. 224	. 198	C70060	. 2213	. 62
C65792	. 0710	. 196	C66694	. 0550	. 199	C66786	. 0554	. 199	C67275	. 0650	. 195,202	C70061	. 2213	. 62
C65793	. 0710	. 196	C66695	. 0550	. 199	C66787	. 0554	. 199	C67276	. 0650	. 195,202	C70062	. 2213	. 62
C65798	. 0710	. 196	C66696	. 0550	. 199	C66788	. 0554	. 199	C67278	. 0650	. 195,202	C70063	. 2213	. 62
C65801	. 0710M	. 198	C66697	. 0550	. 199	C66789	. 0554	. 199	C67282	. 0650	. 195,202	C70064	. 2213	. 62
C65804	. 0710	. 196	C66698	. 0550	. 199	C66790	. 0554	. 199	C67283	. 0650M	. 195,202	C70065	. 2213	. 62
C65805	. 0710	. 196	C66699	. 0550	. 199	C66791	. 0554	. 199	C67284	. 0650	. 202	C70067	. 2213	. 62
C65807	. 0710M	. 198	C66700	. 0550	. 199	C66792	. 0554	. 199	C69496	. 0620	. 197	C70068	. 2213	. 62
C65808	. 0710	. 196	C66701	. 0550	. 199	C66793	. 0554	. 199	C70000	. 2213	. 61	C70070	. 2213	. 62
C65809	. 0710	. 196	C66703	. 0550	. 199	C66794	. 0554	. 199	C70001	. 2213	. 61	C70071	. 2213	. 62
C65813	. 0710M	. 198	C66704	. 0550	. 199	C66795	. 0554	. 199	C70002	. 2213	. 61	C70072	. 2213	. 62
C65816	. 0710	. 196	C66705	. 0550	. 199	C66796	. 0554	. 199	C70003	. 2213	. 62	C70073	. 2213	. 62
C65817	. 0710	. 196	C66706	. 0550	. 199	C66797	. 0554	. 199	C70004	. 2213	. 62	C70074	. 2213	. 62
C65824	. 0710M	. 198	C66707	. 0550	. 199	C66798	. 0554	. 199	C70005	. 2213	. 62	C70076	. 2213	. 62
C65828	. 0710	. 196	C66708	. 0550	. 199	C66801	. 0554	. 199	C70006	. 2213	. 62	C70077	. 2213	. 62
C65829	. 0710	. 196	C66709	. 0550	. 199	C66802	. 0554	. 199	C70007	. 2213	. 62	C70078	. 2213	. 62
C65833	. 0710M	. 198	C66710	. 0550	. 199	C66803	. 0554	. 199	C70008	. 2213	. 63	C70079	. 2213	. 62
C65839	. 0710	. 196	C66711	. 0550	. 199	C66804	. 0554	. 199	C70009	. 2213	. 63	C70080	. 2213	. 62
C65840	. 0710	. 196	C66712	. 0550	. 199	C66805	. 0554	. 199	C70010	. 2213	. 63	C70081	. 2213	. 62
C65844	. 0710	. 196	C66713	. 0550	. 199	C66806	. 0554	. 199	C70011	. 2213	. 63	C70082	. 2213	. 62
C65845	. 0710	. 196	C66714	. 0550	. 199	C66807	. 0554	. 199	C70012	. 2213	. 63	C70083	. 2213	. 63
C65855	. 0710	. 196	C66715	. 0550	. 199	C66808	. 0554	. 199	C70013	. 2213	. 64	C70085	. 2213	. 63
C65856	. 0710	. 196	C66716	. 0550	. 199	C66809	. 0554	. 199	C70014	. 2213	. 64	C70086	. 2213	. 63
C65865	. 0710	. 196	C66717	. 0550	. 199	C66810	. 0554	. 199	C70015	. 2213	. 64	C70087	. 2213	. 63
C65866	. 0710	. 196	C66718	. 0550	. 199	C66811	. 0554	. 199	C70016	. 2213	. 64	C70088	. 2213	. 63
C65875	. 0710	. 197	C66719	. 0550	. 199	C66812	. 0554	. 199	C70017	. 2213	. 64	C70089	. 2213	. 63
C65876	. 0710	. 197	C66720	. 0550	. 199	C66813	. 0554	. 199	C70018	. 2213	. 64	C70090	. 2213	. 63
C65880	. 0710M	. 198	C66721	. 0550	. 199	C66820	. 0551	. 200	C70019	. 2213	. 64	C70091	. 2213	. 63
C65881	. 0710	. 197	C66722	. 0550	. 199	C66821	. 0551	. 200	C70020	. 2213	. 64	C70092	. 2213	. 63
C65882	. 0710	. 197	C66723	. 0550	. 199	C66822	. 0551	. 200	C70021	. 2213	. 64	C70094	. 2213	. 63
C65884	. 0710	. 197	C66727	. 0551	. 199	C66823	. 0551	. 200	C70022	. 2213	. 64	C70095	. 2213	. 63
C65885	. 0710	. 197	C66728	. 0551	. 199	C66824	. 0551	. 200	C70023	. 2213	. 65	C70096	. 2213	. 63
C65889	. 0710M	. 198	C66729	. 0551	. 199	C66825	. 0551	. 200	C70024	. 2213	. 65	C70097	. 2213	. 63



Order Number	Style Number	Page Number	Order Number	Style Number	Page Number	Order Number	Style Number	Page Number	Order Number	Style Number	Page Number	Order Number	Style Number	Page Number
C73462	2228	56	C75044	HG-4C	254	C75112	HG-4MC	256	C75180	HGC-2	265	C75250	HG-2	243
C73463	2228	56	C75045	HG-4C	254	C75113	HG-4MC	256	C75181	HGC-2	265	C75251	HG-2	241
C73464	2228	56	C75046	HG-4C	254	C75114	HG-4B	257	C75182	HGC-2	265	C75252	HG-2	241
C73465	2228	56	C75047	HG-4C	254	C75115	HG-4B	257	C75183	HG-2	241	C75253	HG-2	241
C73466	2228	56	C75048	HG-4C	254	C75116	HG-4B	257	C75184	HG-2	241	C75254	HG-2	242
C73467	2228	56	C75049	HG-4C	254	C75117	HD-2B	238	C75185	HG-2	241	C75255	HG-2	242
C73468	2228	56	C75050	HG-4C	254	C75118	HD-2B	238	C75186	HG-2	242	C75256	HG-2	242
C73469	2228	56	C75051	HG-4C	254	C75119	HD-2B	238	C75187	HG-2	242	C75257	HG-2	242
C73470	2228	56	C75052	HG-4C	255	C75120	HD-2B	238	C75188	HG-2	242	C75258	HG-2	242
C73471	2228	56	C75053	HG-4C	255	C75121	HD-2B	238	C75189	HG-2	242	C75259	HG-2	242
C73472	2228	56	C75054	HG-4C	255	C75122	HD-2B	238	C75190	HG-2	242	C75260	HG-2	242
C73473	2228	56	C75055	HG-4C	255	C75123	HD-2B	238	C75191	HG-2	242	C75261	HG-2	242
C73474	2228	56	C75056	HG-4C	255	C75124	HD-2B	238	C75192	HG-2	242	C75262	HG-2	242
C73475	2228	56	C75057	HG-4C	255	C75125	HD-2B	238	C75193	HG-2	242	C75263	HG-2	242
C73476	2228	56	C75058	HG-4C	255	C75126	HGC-2	264	C75194	HG-2	242	C75264	HG-2	242
C73477	2228	56	C75059	HG-4C	255	C75127	HGC-2	264	C75195	HG-2	242	C75265	HG-2	242
C73478	2228	56	C75060	HG-4C	255	C75128	HGC-2	264	C75196	HG-2	242	C75266	HG-2	242
C73479	2228	56	C75061	HG-4C	255	C75129	HGC-2	264	C75197	HG-2	242	C75267	HG-2	242
C73480	2228	56	C75062	HG-4C	255	C75130	HGC-2	264	C75198	HG-2	242	C75268	HG-2	242
C74995	HD-4C	240	C75063	HG-4C	255	C75131	HGC-2	264	C75199	HG-2	242	C75269	HG-2	242
C74996	HD-4C	240	C75064	HG-4C	255	C75132	HGC-2	264	C75200	HG-2	242	C75270	HG-2	242
C74997	HD-4C	240	C75065	HG-4C	255	C75133	HGC-2	264	C75201	HG-2	242	C75271	HG-2	242
C74998	HD-4C	240	C75066	HG-4C	255	C75134	HGC-2	264	C75202	HG-2	242	C75272	HG-2	242
C74999	HD-4C	240	C75067	HG-4C	254	C75135	HGC-2	265	C75203	HG-2	242	C75273	HG-2	242
C75000	HD-4C	240	C75068	HG-4C	254	C75136	HGC-2	264	C75204	HG-2	242	C75274	HG-2	242
C75001	HD-4C	240	C75069	HG-4C	254	C75137	HGC-2	264	C75205	HG-2	242	C75275	HG-2	243
C75002	HD-4C	240	C75070	HG-4C	254	C75138	HGC-2	264	C75206	HG-2	242	C75276	HG-2	243
C75003	HD-4C	240	C75071	HG-4C	254	C75139	HGC-2	264	C75207	HG-2	243	C75277	HG-2	243
C75004	HD-4C	240	C75072	HG-4C	254	C75140	HGC-2	264	C75208	HG-2	243	C75278	HG-2	243
C75005	HD-4C	240	C75073	HG-4C	254	C75141	HGC-2	264	C75209	HG-2	243	C75279	HG-2	243
C75006	HD-4C	240	C75074	HG-4C	254	C75142	HGC-2	264	C75210	HG-2	243	C75280	HG-2	243
C75007	HD-4C	240	C75075	HG-4C	254	C75143	HGC-2	264	C75212	HG-2	243	C75281	HG-2	243
C75008	HD-4C	240	C75076	HG-4C	254	C75144	HGC-2	264	C75213	HG-2	243	C75282	HG-2	243
C75009	HD-4C	240	C75077	HG-4C	255	C75145	HGC-2	265	C75214	HG-2	243	C75283	HG-2	243
C75010	HD-4C	240	C75078	HG-4C	255	C75146	HGC-2	264	C75215	HG-2	243	C75284	HG-2	243
C75011	HGC-4B	269	C75079	HG-4C	255	C75147	HGC-2	264	C75216	HG-2	243	C75285	HG-2M	244
C75012	HGC-4B	269	C75080	HG-4C	255	C75148	HGC-2	264	C75217	HG-2	241	C75286	HG-2M	244
C75013	HGC-4B	269	C75081	HG-4C	255	C75149	HGC-2	264	C75218	HG-2	241	C75287	HG-2M	244
C75014	HGC-4B	269	C75082	HG-4C	255	C75150	HGC-2	264	C75219	HG-2	241	C75288	HG-2M	244
C75015	HGC-4B	269	C75083	HG-4C	255	C75151	HGC-2	264	C75220	HG-2	242	C75289	HG-2M	244
C75016	HGC-4B	269	C75084	HG-4C	255	C75152	HGC-2	264	C75221	HG-2	242	C75290	HG-2M	244
C75017	HG-4C	254	C75085	HG-4C	255	C75153	HGC-2	264	C75222	HG-2	242	C75291	HG-2M	244
C75018	HG-4C	254	C75086	HG-4C	255	C75154	HGC-2	264	C75223	HG-2	242	C75292	HG-2M	244
C75019	HG-4C	254	C75087	HG-4C	255	C75155	HGC-2	265	C75224	HG-2	242	C75293	HG-2M	244
C75020	HG-4C	254	C75088	HG-4C	255	C75156	HGC-2	265	C75225	HG-2	242	C75294	HG-2M	244
C75021	HG-4C	254	C75089	HG-4C	255	C75157	HGC-2	265	C75226	HG-2	242	C75295	HG-2M	244
C75022	HG-4C	254	C75090	HG-4C	255	C75158	HGC-2	265	C75227	HG-2	242	C75296	HG-2M	244
C75023	HG-4C	254	C75091	HG-4MC	256	C75159	HGC-2	265	C75228	HG-2	242	C75297	HG-2M	244
C75024	HG-4C	254	C75092	HG-4MC	256	C75160	HGC-2	265	C75229	HG-2	242	C75298	HG-2M	244
C75025	HG-4C	254	C75093	HG-4MC	256	C75161	HGC-2	265	C75230	HG-2	242	C75299	HG-2M	244
C75026	HG-4C	254	C75094	HG-4MC	256	C75162	HGC-2	265	C75231	HG-2	242	C75300	HG-2M	244
C75027	HG-4C	255	C75095	HG-4MC	256	C75163	HGC-2	265	C75232	HG-2	242	C75301	HG-2M	244
C75028	HG-4C	255	C75096	HG-4MC	256	C75164	HGC-2	265	C75233	HG-2	242	C75302	HG-2M	244
C75029	HG-4C	255	C75097	HG-4MC	256	C75165	HGC-2	265	C75234	HG-2	242	C75303	HG-2M	244
C75030	HG-4C	255	C75098	HG-4MC	256	C75166	HGC-2	265	C75235	HG-2	242	C75304	HG-2M	244
C75031	HG-4C	255	C75099	HG-4MC	256	C75167	HGC-2	265	C75236	HG-2	242	C75305	HG-2B	245
C75032	HG-4C	255	C75100	HG-4MC	256	C75168	HGC-2	265	C75237	HG-2	242	C75306	HG-2B	245
C75033	HG-4C	255	C75101	HG-4MC	256	C75169	HGC-2	265	C75238	HG-2	242	C75307	HG-2B	245
C75034	HG-4C	255	C75102	HG-4MC	256	C75170	HGC-2	265	C75239	HG-2	242	C75308	HG-2B	245
C75035	HG-4C	255	C75103	HG-4MC	256	C75171	HGC-2	265	C75240	HG-2	242	C75309	HG-2B	245
C75036	HG-4C	255	C75104	HG-4MC	256	C75172	HGC-2	265	C75241	HG-2	243	C75310	HG-2B	245
C75037	HG-4C	255	C75105	HG-4MC	256	C75173	HGC-2	265	C75242	HG-2	243	C75311	HG-2B	245
C75038	HG-4C	255	C75106	HG-4MC	256	C75174	HGC-2	265	C75243	HG-2	243	C75312	HG-2B	245
C75039	HG-4C	255	C75107	HG-4MC	256	C75175	HGC-2	265	C75244	HG-2	243	C75313	HG-2B	245
C75040	HG-4C	255	C75108	HG-4MC	256	C75176	HGC-2	265	C75245	HG-2	243	C75314	HG-2B	245
C75041	HG-4C	255	C75109	HG-4MC	256	C75177	HGC-2	265	C75246	HG-2	243	C75315	HG-2B	245
C75042	HG-4C	254	C75110	HG-4MC	256	C75178	HGC-2	265	C75247	HG-2	243	C75316	HG-2B	245
C75043	HG-4C	254	C75111	HG-4MC	256	C75179	HGC-2	265	C75248	HG-2	243	C75317	HG-2B	245
									C75249	HG-2	243	C75318	HG-2B	245

Order Number	Style Number	Page Number	Order Number	Style Number	Page Number	Order Number	Style Number	Page Number	Order Number	Style Number	Page Number	Order Number	Style Number	Page Number
C89312	PER-893SF	183	C89435	1766	71	C89503	1727	73	C89589	1727	75	C89661	1767	35
C89313	PER-893SF	183	C89436	1766	71	C89504	1727	73	C89590	1727	75	C89662	1767	35
C89314	PER-893SF	183	C89437	1766	71	C89505	1727	73	C89591	1727	75	C89663	1767	35
C89315	PER-893SF	183	C89438	1766	71	C89506	1727	73	C89593	1727	75	C89664	1767	35
C89316	PER-893SF	183	C89439	1766	71	C89507	1727	73	C89594	1727	75	C89665	1767	35
C89317	PER-893SF	183	C89440	1766	71	C89508	1727	73	C89595	1727	75	C89666	1767	35
C89318	PER-893SF	183	C89441	1766	71	C89509	1727	73	C89596	1727	75	C89667	1767	35
C89319	PER-893SF	183	C89442	1766	71	C89512	1727	73	C89597	1727	75	C89668	1767	35
C89320	PER-893SF	183	C89443	1766	71	C89513	1727	73	C89598	1727	75	C89669	1767	35
C89321	PER-893SF	183	C89444	1766	71	C89515	1727	73	C89599	1727	75	C89670	1767	35
C89322	PER-893SF	183	C89445	1766	71	C89516	1727	73	C89600	1727	75	C89671	1767	35
C89323	PER-893SF	183	C89446	1766	71	C89517	1727	73	C89601	1727	75	C89672	1767	35
C89324	PER-893SF	183	C89447	1766	71	C89518	1727	73	C89603	1727	75	C89673	1767	35
C89325	PER-893SF	183	C89448	1766	71	C89519	1727	73	C89604	1727	75	C89674	1767	35
C89326	PER-893SF	183	C89449	1766	71	C89520	1727	73	C89605	1727	75	C89675	1767	35
C89327	PER-893SF	183	C89450	1766	72	C89521	1727	73	C89606	1727	75	C89676	1767	35
C89328	PER-893SF	183	C89451	1766	72	C89522	1727	73	C89607	1727	75	C89677	1767	35
C89329	PER-893SF	183	C89452	1766	72	C89523	1727	73	C89608	1727	75	C89678	1767	35
C89330	PER-893SF	183	C89453	1766	72	C89525	1727	73	C89609	1727	75	C89679	1767	35
C89331	PER-893SF	183	C89454	1766	72	C89527	1727	73	C89610	1727	75	C89680	1767	35
C89332	PER-893SF	183	C89455	1766	72	C89528	1727	73	C89612	1727	75	C89681	1767	36
C89333	PER-893SF	183	C89456	1766	72	C89529	1727	73	C89613	1727	75	C89682	1767	36
C89334	PER-893SF	184	C89457	1766	72	C89530	1727	73	C89614	1727	75	C89683	1767	36
C89335	PER-893SF	184	C89458	1766	72	C89532	1727	73	C89616	1767	36	C89684	1767	36
C89336	PER-893SF	184	C89459	1766	72	C89533	1727	73	C89617	1767	36	C89685	1767	36
C89337	PER-893SF	184	C89460	1766	72	C89534	1727	73	C89618	1767	36	C89686	1767	36
C89338	PER-893SF	184	C89461	1766	72	C89535	1727	74	C89619	1767	36	C89687	1767	36
C89339	PER-893SF	184	C89462	1766	72	C89536	1727	74	C89620	1767	36	C89688	1767	36
C89340	PER-893SF	184	C89463	1766	72	C89539	1727	74	C89621	1767	36	C89689	1767	36
C89341	PER-893SF	184	C89464	1766	72	C89540	1727	74	C89622	1767	36	C89690	1767	36
C89342	PER-893SF	184	C89465	1766	72	C89543	1727	74	C89623	1767	36	C89691	1767	36
C89343	PER-893SF	184	C89466	1766	72	C89544	1727	74	C89624	1767	36	C89692	1767	36
C89344	PER-893SF	184	C89467	1766	72	C89545	1727	74	C89625	1767	36	C89693	1767	36
C89345	PER-893SF	184	C89468	1766	72	C89546	1727	74	C89626	1767	36	C89694	1767	36
C89346	PER-893SF	184	C89469	1766	72	C89548	1727	74	C89627	1767	36	C89695	1767	36
C89347	PER-893SF	184	C89470	1766	72	C89549	1727	74	C89628	1767	36	C89696	1767	36
C89348	PER-893SF	184	C89471	1766	72	C89550	1727	74	C89629	1767	36	C89697	1767	36
C89349	PER-893SF	184	C89472	1766	72	C89551	1727	74	C89630	1767	36	C89698	1767	36
C89350	PER-893SF	184	C89473	1766	72	C89552	1727	74	C89631	1767	36	C89699	1767	36
C89351	PER-893SF	184	C89474	1766	72	C89554	1727	74	C89632	1767	36	C89700	1767	36
C89352	PER-893SF	184	C89475	1766	72	C89555	1727	74	C89633	1767	36	C89701	1767	36
C89353	PER-893SF	184	C89476	1766	72	C89556	1727	74	C89634	1767	36	C89702	1767	36
C89354	PER-893SF	184	C89477	1766	72	C89557	1727	74	C89635	1767	36	C89703	1767	36
C89410	1766	71	C89478	1766	72	C89558	1727	74	C89636	1767	36	C89704	1767	36
C89411	1766	71	C89479	1766	72	C89560	1727	74	C89637	1767	36	C89705	1765	34
C89412	1766	71	C89480	1766	72	C89561	1727	74	C89638	1767	36	C89706	1765	34
C89413	1766	71	C89481	1766	72	C89563	1727	74	C89639	1767	36	C89707	1765	34
C89414	1766	71	C89482	1766	72	C89564	1727	74	C89640	1767	36	C89708	1765	34
C89415	1766	71	C89483	1766	72	C89566	1727	74	C89641	1767	36	C89709	1765	34
C89416	1766	71	C89484	1766	72	C89568	1727	74	C89642	1767	36	C89710	1765	34
C89417	1766	71	C89485	1766	72	C89569	1727	74	C89643	1767	36	C89711	1765	34
C89418	1766	71	C89486	1766	72	C89570	1727	74	C89644	1767	36	C89712	1765	34
C89419	1766	71	C89487	1766	72	C89572	1727	74	C89645	1767	35	C89713	1765	34
C89420	1766	71	C89488	1766	72	C89573	1727	74	C89646	1767	35	C89714	1765	34
C89421	1766	71	C89489	1766	72	C89574	1727	74	C89647	1767	35	C89715	1765	34
C89422	1766	71	C89490	1766	72	C89575	1727	74	C89648	1767	35	C89716	1765	34
C89423	1766	71	C89491	1766	72	C89576	1727	74	C89649	1767	35	C91695	183	128
C89424	1766	71	C89492	1766	72	C89577	1727	74	C89650	1767	35	C91696	183	128
C89425	1766	71	C89493	1766	72	C89578	1727	74	C89651	1767	35	C91697	183	128
C89426	1766	71	C89494	1766	72	C89580	1727	75	C89652	1767	35	C91698	183	128
C89427	1766	71	C89495	1766	72	C89581	1727	75	C89653	1767	35	C91699	183	128
C89428	1766	71	C89496	1766	72	C89582	1727	75	C89654	1767	35	C91700	183	128
C89429	1766	71	C89497	1766	72	C89583	1727	75	C89655	1767	35	C91701	183	128
C89430	1766	71	C89498	1766	72	C89584	1727	75	C89656	1767	35	C91703	183	128
C89431	1766	71	C89499	1766	72	C89585	1727	75	C89657	1767	35	C91709	183	128
C89432	1766	71	C89500	1766	72	C89586	1727	75	C89658	1767	35	C91710	183	128
C89433	1766	71	C89501	1727	73	C89587	1727	75	C89659	1767	35	C91711	183	128
C89434	1766	71	C89502	1727	73	C89588	1727	75	C89660	1767	35	C91712	183	128

Tap & Drill Recommendations Machine Screw, Fractional, and Metric Sizes



Tap Size & Pitch		Cutting Taps		Forming Taps		Tap Size & Pitch		Cutting Taps		Forming Taps	
		drill size	decimal inch	drill size	decimal inch			drill size	decimal inch	drill size	decimal inch
inch	metric					inch	metric				
0-80		3/64	.0469	54	.0550		M12 x 1,75	10,2	.4016	11,2	.4409
	M1,6 x 0,35	1,25	.0492	1,45	.0571		M12 x 1,25	10,8	.4252	11,5	.4528
	M1,8 x 0,35	1,45	.0571	1,65	.0650	1/2-13		27/64	.4219	15/32	.4688
1-64		53	.0595	51	.0670	1/2-20		29/64	.4531	12,25	.4823
1-72		53	.0595	51	.0670		M14 x 2	12,0	.4724	33/64	.5156
	M2 x 0,4	1,6	.0630	1,8	.0709	9/16-12		31/64	.4844	17/32	.5312
2-56		50	.0700	5/64	.0781	9/16-18		33/64	.5156	13,5	.5315
2-64		50	.0700	47	.0785	5/8-11		17/32	.5312	14,75	.5807
	M2,2 x 0,45	1,75	.0689	2,0	.0787	5/8-18		37/64	.5781	15,25	.6004
	M2,5 x 0,45	2,05	.0807	2,3	.0906		M16 x 2	14,0	.5512	19/32	.5938
3-48		47	.0785	43	.0890		M16 x 1,5	14,5	.5709	15,25	.6004
3-56		46	.0810	2,3	.0906		M18 x 2,5	15,5	.6102	39/64	.6094
4-40		43	.0890	38	.1015		M18 x 1,5	16,5	.6496	17,25	.6791
4-48		42	.0935	2,6	.1024	3/4-10		21/32	.6562	45/64	.7031
	M3 x 0,5	2,5	.0984	7/64	.1094	3/4-16		11/16	.6875	23/32	.7188
5-40		38	.1015	33	.1130		M20 x 2,5	17,5	.6890		
5-44		37	.1040	2,9	.1142		M20 x 1,5	18,5	.7283		
	M3,5 x 0,6	2,9	.1142	3,2	.1260		M22 x 2,5	19,5	.7677		
6-32		36	.1065	1/8	.1250		M22 x 1,5	20,5	.8071		
6-40		33	.1130	3,25	.1280	7/8-9		49/64	.7656		
	M4 x 0,7	3,3	.1299	3,7	.1457	7/8-14		13/16	.8125		
8-32		29	.1360	25	.1495		M24 x 3	21,0	.8268		
8-36		29	.1360	24	.1520		M24 x 2	22,0	.8661		
	M4,5 x 0,75	3,7	.1457	4,1	.1614	1-8		7/8	.8750		
10-24		26	.1470	11/64	.1719	1-12		59/64	.9219		
10-32		21	.1590	16	.1770		M27 x 3	24,0	.9449		
	M5 x 0,8	4,2	.1654	14	.1820		M27 x 2	25,0	.9843		
12-24		16	.1770	8	.1990	1-1/8-7		63/64	.9844		
12-28		15	.1800	7	.2010	1-1/8-12		1-3/64	1.0469		
	M6 x 1	5,0	.1969	7/32	.2188		M30 x 3,5	26,5	1.0433		
1/4-20		7	.2010	1	.2280		M30 x 2	28,0	1.1024		
1/4-28		3	.2130	15/64	.2340	1-1/4-7		1-7/64	1.1094		
	M7 x 1	6,0	.2362	F	.2570	1-1/4-12		1-11/64	1.1719		
5/16-18		F	.2570	L	.2900		M33 x 3,5	29,5	1.1614		
5/16-24		I	.2720	M	.2950		M33 x 2	31,0	1.2205		
	M8 x 1,25	6,7	.2638	7,4	.2913	1-3/8-6		1-7/32	1.2188		
	M8 x 1	7,0	.2756	19/64	.2969	1-3/8-12		1-19/64	1.2969		
3/8-16		5/16	.3125	S	.3480		M36 x 4	32,0	1.2598		
3/8-24		Q	.3320	T	.3580		M36 x 3	33,0	1.2992		
	M10 x 1,5	8,5	.3346	U	.3680	1-1/2-6		1-11/32	1.3438		
	M10 x 1,25	8,7	.3425	9,4	.3701	1-1/2-12		1-27/64	1.4219		
7/16-14		U	.3680	Y	.4040		M39 x 4	35,0	1.3780		
7/16-20		25/64	.3906	Z	.4130		M39 x 3	36,0	1.4173		

**FORM
TAPS
NOT
AVAILABLE
IN
THESE
SIZES**

Pipe Taps — NPT, NPTF, NPSM, NPSC, NPSF Sizes

Nominal Tap Size & Pitch	NPT & NPTF		NPSM	NPSC	NPSF
	w/o reamer	w/ reamer			
1/16 - 27	C (.242)	A (.234)	—	1/4	D (.246)
1/8 - 27	Q (.332)	21/64	T (.358)	Q	R (.339)
1/4 - 18	7/16	27/64	15/32	7/16	7/16
3/8 - 18	9/16	9/16	.603*	37/64	37/64
1/2 - 14	45/64	11/16	19,0mm	23/32	.705*
3/4 - 14	29/32	57/64	61/64	59/64	59/64
1 - 11 1/2	1 9/64	1 1/8	1 13/64	1 5/32	1 5/32
1 1/4 - 11 1/2	1 31/64	1 15/32	1.546*	1 1/2	—
1 1/2 - 11 1/2	1 23/32	1 45/64	1 25/32	1 47/64	—
2 - 11 1/2	2 3/16	2 11/64	2 1/4	2 1/4	—

*special



Decimal Equivalents

DRILL SIZE	DECIMAL INCHES	DRILL SIZE	DECIMAL INCHES	DRILL SIZE	DECIMAL INCHES	DRILL SIZE	DECIMAL INCHES	DRILL SIZE	DECIMAL INCHES	DRILL SIZE	DECIMAL INCHES
0.30mm	.0118	1.40mm	.0551	3.20mm	.1260	7/32	.2188	8.60mm	.3386	37/64	.5781
0.32mm	.0126	1.45mm	.0571	30	.1285	5.60mm	.2205	R	.3390	14.75mm	.5807
80	.0135	1.50mm	.0591	3.30mm	.1299	2	.2210	8.70mm	.3425	15.00mm	.5906
0.35mm	.0138	53	.0595	3.40mm	.1339	5.70mm	.2244	11/32	.3438	19/32	.5938
79	.0145	1.55mm	.0610	29	.1360	1	.2280	8.80mm	.3465	15.25mm	.6004
0.38mm	.0150	1/16	.0625	3.50mm	.1378	5.80mm	.2283	S	.3480	39/64	.6094
1/64	.0156	1.60mm	.0630	28	.1405	5.90mm	.2323	8.90mm	.3504	15.50mm	.6102
0.40mm	.0157	52	.0635	9/64	.1406	A	.2340	9.00mm	.3543	15.75mm	.6201
78	.0160	1.65mm	.0650	3.60mm	.1417	15/64	.2344	T	.3580	5/8	.6250
0.42mm	.0165	1.70mm	.0669	27	.1440	6.00mm	.2362	9.10mm	.3583	16.00mm	.6299
0.45mm	.0177	51	.0670	3.70mm	.1457	B	.2380	23/64	.3594	16.25mm	.6398
77	.0180	1.75mm	.0689	26	.1470	6.10mm	.2402	9.20mm	.3622	41/64	.6406
0.48mm	.0189	50	.0700	25	.1495	C	.2420	9.30mm	.3661	16.50mm	.6496
0.50mm	.0197	1.80mm	.0709	3.80mm	.1496	6.20mm	.2441	U	.3680	21/32	.6562
76	.0200	1.85mm	.0728	24	.1520	D	.2460	9.40mm	.3701	16.75mm	.6594
75	.0210	49	.0730	3.90mm	.1535	6.30mm	.2480	9.50mm	.3740	17.00mm	.6693
0.55mm	.0217	1.90mm	.0748	23	.1540	1/4	.2500	3/8	.3750	43/64	.6719
74	.0225	48	.0760	5/32	.1562	E	.2500	V	.3770	17.25mm	.6791
0.60mm	.0236	1.95mm	.0768	22	.1570	6.40mm	.2520	9.60mm	.3780	11/16	.6875
73	.0240	5/64	.0781	4.00mm	.1575	6.50mm	.2559	9.70mm	.3819	17.50mm	.6890
0.62mm	.0244	47	.0785	21	.1590	F	.2570	9.80mm	.3858	45/64	.7031
72	.0250	2.00mm	.0787	20	.1610	6.60mm	.2598	W	.3860	18.00mm	.7087
0.65mm	.0256	2.05mm	.0807	4.10mm	.1614	G	.2610	9.90mm	.3898	23/32	.7188
71	.0260	46	.0810	4.20mm	.1654	6.70mm	.2638	25/64	.3906	18.50mm	.7283
0.70mm	.0276	45	.0820	19	.1660	17/64	.2656	1.00mm	.3937	47/64	.7344
70	.0280	2.10mm	.0827	4.30mm	.1693	H	.2660	X	.3970	19.00mm	.7480
69	.0292	2.15mm	.0846	18	.1695	6.80mm	.2677	1.20mm	.4016	3/4	.7500
0.75mm	.0295	44	.0860	11/64	.1719	6.90mm	.2717	Y	.4040	49/64	.7656
68	.0310	2.20mm	.0866	17	.1730	I	.2720	13/32	.4062	19.50mm	.7677
1/32	.0312	2.25mm	.0886	4.40mm	.1732	7.00mm	.2756	Z	.4130	25/32	.7812
0.80mm	.0315	43	.0890	16	.1770	J	.2770	10.50mm	.4134	20.00mm	.7874
67	.0320	2.30mm	.0906	4.50mm	.1772	7.10mm	.2795	27/64	.4219	51/64	.7969
66	.0330	2.35mm	.0925	15	.1800	K	.2810	10.80mm	.4252	20.50mm	.8071
0.85mm	.0335	42	.0935	4.60mm	.1811	9/32	.2812	11.00mm	.4331	13/16	.8125
65	.0350	3/32	.0938	14	.1820	7.20mm	.2835	7/16	.4375	21.00mm	.8268
0.90mm	.0354	2.40mm	.0945	4.70mm	.1850	7.30mm	.2874	11.20mm	.4409	53/64	.8281
64	.0360	41	.0960	13	.1850	L	.2900	11.50mm	.4528	27/32	.8438
63	.0370	2.45mm	.0965	3/16	.1875	7.40mm	.2913	29/64	.4531	21.50mm	.8465
0.95mm	.0374	40	.0980	12	.1890	M	.2950	11.80mm	.4646	55/64	.8594
62	.0380	2.50mm	.0984	4.8mm	.1890	7.50mm	.2953	15/32	.4688	22.00mm	.8661
61	.0390	39	.0995	11	.1910	19/64	.2969	12.00mm	.4724	7/8	.8750
1.00mm	.0394	38	.1015	4.90mm	.1929	7.60mm	.2992	12.20mm	.4803	22.50mm	.8858
60	.0400	2.60mm	.1024	10	.1935	N	.3020	31/64	.4844	57/64	.8906
59	.0410	37	.1040	9	.1960	7.70mm	.3031	12.50mm	.4921	23.00mm	.9055
1.05mm	.0413	2.70mm	.1063	5.00mm	.1969	7.80mm	.3071	1/2	.5000	29/32	.9062
58	.0420	36	.1065	8	.1990	7.90mm	.3110	12.80mm	.5039	59/64	.9219
57	.0430	7/64	.1094	5.10mm	.2008	5/16	.3125	13.00mm	.5118	23.50mm	.9252
1.10mm	.0433	35	.1100	7	.2010	8.00mm	.3150	33/64	.5156	15/16	.9375
1.15mm	.0453	2.80mm	.1102	13/64	.2031	O	.3160	13.20mm	.5197	24.00mm	.9449
56	.0465	34	.1110	6	.2040	8.10mm	.3189	17/32	.5312	61/64	.9531
3/64	.0469	33	.1130	5.20mm	.2047	8.20mm	.3228	13.50mm	.5315	24.50mm	.9646
1.20mm	.0472	2.90mm	.1142	5	.2055	P	.3230	13.80mm	.5433	31/32	.9688
1.25mm	.0492	32	.1160	5.30mm	.2087	8.30mm	.3268	35/64	.5469	25.00mm	.9843
1.30mm	.0512	3.00mm	.1181	4	.2090	21/64	.3281	14.00mm	.5512	63/64	.9844
55	.0520	31	.1200	5.40mm	.2126	8.40mm	.3307	14.25mm	.5610	1	1.0000
1.35mm	.0531	3.10mm	.1220	3	.2130	Q	.3320	9/16	.5625		
54	.0550	1/8	.1250	5.50mm	.2165	8.50mm	.3346	14.50mm	.5709		

FRACTIONAL - RED

WIRE GAGE - PURPLE

LETTER - BLUE

METRIC - GREEN



The
CLEVELAND
 TWIST DRILL CO... Since 1874



CLEVELAND



TDC

2501 Davis Creek Road, Seneca, SC 29678 U.S.A.

USA

website www.gfii.com
 telephone 800.348.2885
 fax 800.892.4290
 email standard.distributors@gfii.com

International

telephone 864.653.3904
 email international.distributors@gfii.com

Canada

website www.gfii.ca
 telephone 800.348.2885
 fax 800.387.6649
 email canada.distributors@gfii.com



CTDCAT21



CLEVEVELAND

Hoiermaking, Threearing, Milling



2021